

iCHiL

IC200L Series



User manual

DIXELL

INDEX

1	GENERAL ADVICE	7
2	GENERAL FEATURES	8
2.1	MAIN FUNCTION	8
3	IC200 L TABLE OF THE FEATURES	10
4	USER INTERFACE	11
4.1	FUNCTION OF THE LEDS OF THE KEY BUTTONS	11
4.2	USE OF THE LED ON THE MODELS VI620 - VI620S REMOTE PANELS	13
4.3	USE OF THE LED ON THE MODELS VI820 - VI820S REMOTE PANELS	13
4.4	KEY FUNCTION	14
4.5	KEY COMBINANTION	15
4.6	LED AND ICONS	15
4.7	DISPLAY AND ICONS	16
4.8	MEANING/ FUNCTIONNING OF THE BOTTOM DISPLAY LED	17
5	REMOTE TERMINAL	17
6	FIRST INSTALLING	17
6.1	ON BOARD CLOCK (OPTIONAL)	17
6.2	RTC SETUP	17
7	WIRING CONNECTIONS	18
7.1	HARDWARE RESOURCES FOR IC260L - IC280L MODELS	18
7.2	HARDWARE RESOURCES FOR IC261L - IC281L MODELS	18
7.3	ANALOG INPUTS NTC – PTC PROBES	19
7.4	DIGITAL INPUTS	19
7.5	ANALOG INPUT FOR PRESSURE TRANSDUCER PP30 (4 ÷ 20MA SIGNAL)	19
7.6	ANALOG INPUT FOR PRESSURE RATIOMETRIC TRANSDUCER PPR30 (0 ÷ 5V SIGNAL)	20
7.7	PWM OUTPUT FOR CONDENSING FAN SPEED CONTROL	20
7.8	FAN CONDENSING CONTROL: 0 ÷ 10VDC OUTPUTS	21
7.9	FAN CONDENSING CONTROL WITH 4÷20MA OUTPUT	21
7.10	PROPORTIONAL OUTPUTS 0 ÷ 10V DUMPER CONTROL	22
7.11	PROPORTIONAL OUTPUTS CONFIGURED FOR AUX RELAY CONTROL	22
7.12	HOT KEY 64 CONNECTION	23
7.13	XJ485 CONNECTION	23
7.14	REMOTE PANELS VI620 – VI820	24
8	ANALOG AND DIGITAL OUTPUT CONFIGURATION	24
8.1	ANALOG INPUT PB1 - PB2 - PB7 - PB8 - PB9 - PB10	24
8.2	ANALOG INPUT CONFIGURATION PB3 - PB4 - PB5 - PB6	25
8.3	DIGITAL INPUT CONFIGURATION ID1 – ID18	25
8.4	DIGITAL OUTPUT (RELAY) CONFIGURATION RL1- RL14	26
8.5	CONDENSER PROPORTIONAL CONTROL CONFIGURATION (2 OUTPUTS)	27
8.6	PROPORTIONAL OUTPUT CONFIGURATION 0 ÷ 10 VDC (4 OUTPUTS)	27
8.7	OTHER OUTPUTS	27
9	TABLE OF THE PARAMETERS	28
10	PROGRAMMING WITH THE “HOT KEY 64”	41
10.1	DOWNLOAD: HOW TO PROGRAM AN INSTRUMENT WITH A PROGRAMMED “HOT KEY”	41
10.2	UPLOAD: HOW TO PROGRAM A “HOT KEY” WITH THE PARAMETERS OF THE INSTRUMENT	42
11	PROGRAMMING USING THE KEYBOARD	42
11.1	PASSWORD DEFAULT VALUES	42
11.2	ENTER THE PR1 - PR2 - PR3 PROGRAMMING LEVELS	42
11.3	HOW TO CHANGE A PARAMETER VALUE	42
11.4	CHANGE THE PASSWORD VALUE	42
11.5	ENTER THE PROGRAMMING LEVEL PR1	43
11.6	ENTER THE PROGRAMMING LEVEL PR2	43
11.7	ENTER THE PROGRAMMING LEVEL PR3	44
11.8	MOVE A PARAMETER LEVEL FROM PR2 TO PR1	44
11.9	MOVE A PARAMETER FROM PR3 TO PR2 TO PR1	45
11.10	VISIBILITY AND PARAMETER VALUE LOCKED	45
11.11	PROGRAMMING: DIGITAL INPUT AND OUTPUT POLARITY	45
11.12	CHANGE THE POLARITY OF THE DIGITAL INPUTS-OUTPUTS	45
12	SELECTION AND START OF THE RUNNING MODE	46
12.1	SELECT THE CHILLER OR THE HEAT PUMP MODE	46
12.2	CHANGE OVER	46

12.3	CHILLER – HEAT PUMP FUNCTIONING MODE	46
12.4	KEYBOARD SELECTION	46
12.5	ANALOG INPUT SELECTION	46
13	UNIT START- STOP	47
13.1	START – STOP AND STAND- BY FROM KEYBOARD	47
13.2	UNIT START- STOP FROM DIGITAL INPUT	47
14	DISPLAY LAYOUT	47
14.1	HOW TO SHOW THE MEASUREMENT LIST.	47
14.2	SHOW THE CIRCUIT 1 OR 2	47
15	CUSTOM DISPLAY	48
15.1	DEFAULT READ - OUT OF THE TOP DISPLAY	48
15.2	DEFAULT READ - OUT OF THE BOTTOM DISPLAY	50
15.3	FORCED READ - OUT OF THE TOP AND BOTTOM DISPLAY	50
15.4	DEFAULT DISPLAY READ - OUT OF THE REMOTE PANELS VI620S AND VI820S	51
15.5	DEFAULT DISPLAY READ - OUT OF THE REMOTE PANELS VI620S AND VI820S	51
16	DISPLAY INFORMATION	51
16.1	SHOW THE SET POINT VALUE	51
16.2	MODIFY THE SET POINT	51
16.3	SHOW THE ACTIVE SETPOINT DURING ENERGY SAVING OR DYNAMIC SETPOINT	51
16.4	DISPLAY IN REMOTE OFF	52
16.5	DISPLAY IN MOTOCONDENSING CONFIGURATION	52
17	FUNCTION MENU “ M” KEY	52
17.1	ALARM LIST: SHOW AND RESET	52
17.2	COMPRESSOR OVERLOAD ALARM RESET	52
17.3	COMPRESSOR OVERLOAD PASSWORD.	53
17.4	ALARM LOG LIST	53
17.5	ERASE THE ALARM LOG LIST	53
17.6	PASSWORD VALUE OF THE ALARM LIST	53
17.7	DISABLE – ENABLE A SINGLE CIRCUIT	53
17.8	READ-OUT OF A CIRCUIT NOT ENABLED	53
17.9	ENABLE OR DISABLE A SINGLE COMPRESSOR	53
17.10	READ-OUT OF A COMPRESSOR NOT ENABLED	54
17.11	READ-OUT OF THE COMPRESSOR DISCHARGE TEMPERATURE PROBE	54
17.12	READ-OUT OF THE RUNNING HOURS	54
17.13	RESET THE RUNNING HOUR	54
17.14	READ-OUT OF THE COMPRESSOR STARTS-UP	54
17.15	RESET THE STARTS-UP NUMBER	54
17.16	READ-OUT OF THE PROPORTIONAL OUTPUT PERCENTAGE OF THE CONDENSER FAN CONTROL	55
17.17	READ-OUT OF THE FOUR PROPORTIONAL OUTPUT	55
17.18	READ-OUT OF THE TIME COUNTING TO THE NEXT DEFROST	55
17.19	READ-OUT OF THE PROBES CONFIGURED TO CONTROL AN AUXILIARY OUTPUT RELAY	55
17.20	HOW TO DISPLAY THE TEMPAERATURE OF THE INTERNAL TEMPERAURE SENSOR OF THE REMOTE TERMINALS 1 OR 2	55
18	ENERGY SAVING	56
18.1	ENERGY SAVING FROM DIGITAL INPUT	56
18.2	ENERGY SAVING TIME TABLE WITH RTC	56
18.3	RTC DAILY TIME TABLE PROGRAMMING	56
18.4	ENERGY SAVING OR UNIT ON/OFF ACTIVATION WITH RTC PROGRAMMING	56
19	DYNAMIC SETPOINT	57
19.1	DYNAMIC SETPOINT GRAPH	58
20	AUXILIARY RELAYS	59
20.1	AUXILIARY RELAY WITH DIRECT ACTION	59
20.2	AUXILIARY RELAY WITH INVERSE ACTION	59
21	COMPRESSOR THERMOREGULATION	59
21.1	THERMOREGULATION PARAMETER DESCRIPTION	59
22	SELECTION OF THE KIND OF THERMOREGULATION	60
22.1	GRAPH OF THE COMPRESSOR THERMOREGULATION IN CHILLER	60
22.2	GRAPH OF THE COMPRESSOR THERMOREGULATION IN HEAT PUMP	61
22.3	GRAPH NEUTRAL ZONE COMPRESSOR CONTROL	61
22.4	GRAPH PROPORTIONAL INTEGRAL COMPRESSOR REGULATION CONTROL	61
23	THERMOREGULATION OF THE ANTI FREEZE, INTEGRATION HEATING OR BOILER	61
23.1	THERMOREGULATION OF THE HEATERS IN CHILLER	61
23.2	THERMOREGULATION OF THE HEATERS IN HEAT PUMP	61

23.3	THERMOREGULATION OF THE SUPPORT HEATERS FOR AIR/AIR UNIT	62
23.4	CONDENSER ANTI-FREEZE HEATERS REGULATION	62
23.5	THE THERMOREGULATION OF THE ANTI-FREEZE HEATERS OF THE CONDENSER/RECOVERY	62
23.6	GRAPH OF THE ANTI-FREEZE- INTEGRATION HEATING - BOILER HEATER RELAYS	63
23.7	BOILER THERMOREGULATION(ANTIFREEZE), BOILER FUNCTION	63
24	ANTI - FREEZE ALARM AND HEATERS REGULATION THROUGH DIGITAL INPUT	63
25	THERMOREGULATION AND COMPRESSORS ROTATION	64
26	SATURATION - CIRCUIT BALANCING	64
27	COMPRESSORS	64
27.1	COMPRESSORS START- UP	64
27.2	DIRECT START- UP	64
27.3	DIRECT START- UP OF A CAPACITY COMPRESSOR	65
27.4	PART WINDING	65
27.5	COMPRESSOR START- UP WITH PART WINDING	65
27.6	PART WINDING START- UP OF COMPRESSORS OR CAPACITY COMPRESSORS	65
27.7	STAR - DELTA START	65
27.8	STAR - DELTA START OF A COMPRESSOR	66
27.9	STAR - DELTA START- UP OF A CAPACITY COMPRESSOR	66
28	CAPACITY CONTROL	66
28.1	MINIMUM LOAD START- UP	67
28.2	BY- PASS GAS VALVE DURING COMPRESSOR START- UP	68
28.3	SOLENOID VALVE INTERMITTENT FOR SCREW COMPRESSOR	68
29	PUMP DOWN	68
29.1	OFF UNIT WITH PUMP DOWN AND WITH LOW PRESSURE SWITCH CONTROL	68
29.2	PUMP DOWN WITH DEDICATED PRESSURE SWITCH	68
29.3	PUMP DOWN FUNCTION WITH DEDICATED PRESSURE PROBE	69
29.4	PUMP DOWN ALARM DURING COMPRESSORS START- UP	69
29.5	PUMP DOWN ALARM DURING COMPRESSORS SWITCHING OFF	70
29.6	PUMP DOWN INFORMATION	70
30	UNLOADING	70
30.1	HIGH TEMPERATURE OF THE EVAPORATOR WATER INLET	70
30.2	UNLOADING DESCRIPTION	70
30.3	UNLOADING INFORMATION	70
30.4	UNLOADING WITH PRESSURE, CONDENSING TEMPERATURE OR EVAPORATING PRESSURE CONTROL	71
30.5	REGULATION	71
30.6	OTHER INFORMATION ABOUT THE UNLOADING IN CHILLER	71
30.7	OTHER INFORMATION ABOUT THE UNLOADING IN HEAT PUMP	71
31	SOLENOID VALVE FOR LIQUID INJECTION	71
31.1	FUNCTIONNING	71
32	WATER PUMP OF THE EVAPORATOR / SUPPLY FAN	72
32.1	WATER PUMP OF THE EVAPORATOR / SUPPLY FAN (AIR/AIR)	72
32.2	HOT START (SUPPLY FAN) ONLY FOR AIR / AIR UNIT IN HEAT PUMP MODE	72
33	EVAPORATOR PUMP GROUP	72
33.1	EVAPORATOR WATER PUMP ROTATION	72
33.2	EVAPORATOR WATER PUMP ROTATION THROUGH DIGITAL INPUT CONTROL	72
33.3	HOT START	73
34	WATER PUMP OF THE CONDENSER	73
34.1	CONDENSER WATER PUMP CONTROL	73
35	PUMP GROUP OF THE CONDENSER	73
35.1	CONDENSER WATER PUMP ROTATION	73
35.2	CONDENSER WATER PUMP ROTATION THROUGH DIGITAL INPUT CONTROL	73
36	LOAD MAINTENANCE	74
36.1	COMPRESSOR MAINTENANCE RESQUESTS	74
37	CONDENSER FAN REGULATION	74
37.1	OUTPUT STEP RELE' CONDENSER FAN	75
37.2	PWM OUTPUT FOR FAN CONTROL	75
37.3	CONDENSING UNIT: COMMON OR SEPARATE	75
37.4	GRAPH: PROPORZIONAL REGULATION OF CONDENSER FANS	75
37.5	GRAPH: ON / OFF REGULATION OF THE CONDENSER FAN IN CHILLER MODE	77
37.6	GRAPH: ON / OFF REGULATION OF THE CONDENSER FAN IN HEAT PUMP MODE	77

38	DEFROST CYCLE	77
38.1	FORCED DEFROST	77
38.2	COMBINED DEFROST	77
38.3	MANUAL DEFROST	78
38.4	DEFROST START CONDITION WITH TWO CIRCUIT UNIT	78
38.5	END OF THE DEFROST IN A TWO CIRCUITS WITH ONE CONDENSING FAN CONTROL UNIT	78
38.6	AUTOMATIC DEFROST PROCEDURE	78
38.7	OTHER INFORMATION ABOUT THE DEFROST	79
38.8	DEFROST PARAMETER DESCRIPTION	79
39	RECOVERY	81
39.1	UNIT WITH TWO SEPARATE HYDRAULIC CIRCUITS	81
39.2	UNIT WITH TWO HYDRAULIC CIRCUIT WORKING IN PARALLEL	82
40	CONDENSER TEMPERAURE / PRESSURE CONDITION TO ENABLE/DISABLE THE RECOVERY CYCLE	82
40.1	RECOVERY DISABLED	82
40.2	RECOVERY ENABLED	83
40.3	NOTE ABOUT RECOVERY ENABLED/DISABLED	83
41	MESSAGES - ALARM CODES	83
41.1	AP1 - AP2 - AP3 - AP4 - AP5 - AP6 - AP7 - AP8 - AP9 - AP10 - AP11 - AP12 PROBE FAILURE	83
41.2	AEFL: EVAPORATOR FLOW ALARM (DIFFERENTIAL PRESSURE SWITCH)	83
41.3	ACFL: CONDENSER FLOW ALARM (DIFFERENTIAL PRESSURE SWITCH)	83
41.4	ATSF: OVERLOAD ALARM OF THE SUPPLY FAN	84
41.5	ATE1 - ATE2 EVAPORATOR PUMP OVERLOAD ALARM	84
41.6	ATC1 - ATC2 CONDENSER/RECOVERY PUMP OVERLOAD ALARM	84
41.7	AEE EEPROM ALARM	84
41.8	AFR: POWER SUPPLY FREQUENCY ALARM	85
41.9	ALOC: GENERIC ALARM WITH STOP REGULATION	85
41.10	ACF1 - ACF2 - ACF3 - ACF4 - ACF5 - ACF6 - ACF7 - ACF8 - ACF9 CONFIGURATION ALARM OF THE UNIT	85
41.11	ARTF CLOCK FAILURE	86
41.12	ARTC CLOCK ALARM	87
41.13	AEUN: UNLOADING ALARM FROM HIGH TEMPERATURE OF THE EVAPORATOR WATER INLET	87
41.14	ALTI: LOW AIR AMBIENT TEMPERATURE (AIR / AIR UNIT ONLY)	87
41.15	AEP1 - AEP2 EVAPORATOR PUMPS / SUPPLY FAN MAINTENANCE REQUEST	87
41.16	ACP1 - ACP12 CONDENSER PUMPS MAINTENANCE REQUEST	88
41.17	B1HP - B2HP HIGH PRESSURE SWITCH CIRCUIT 1 AND 2	88
41.18	B1LP - B2LP LOW TEMPERATURE / LOW CONDENSING PRESSURE OF THE CIRCUIT	88
41.19	B1AC - B2AC - B1AC - B2AC ANTIFREEZE ALARM / LOW OUTLET TEMPERATURE (AIR / AIR UNIT IN CHILLER MODE)	88
41.20	B1AH - B2AH ANTI-FREEZE ALARM / LOW OUTLET AIR TEMPERAURE(AIR/AIR UNIT ONLY) ON HEAT PUMP MODE	89
41.21	B1HP - B2HP HIGH PRESSURE / CONDENSING HIGH TEMPERATURE OF THE CIRCUIT	89
41.22	B1LP - B2LP LOW PRESSURE SWITCH CIRCUIT #1 OR 2	89
41.23	B1LP - B2LP LOW EVAPORATING PRESSURE OF THE CIRCUIT (WITH PRESSURE TRANSDUCERS ONLY)	89
41.24	B1TF - B2TF CONDENSER FAN OVERLOAD ALARM	90
41.25	C1HP - C2HP - C3HP - C4HP - C5HP - C6HP COMPRESSOR HIGH PRESSURE ALARMS	90
41.26	C1OP - C2OP - C3OP - C4OP - C5OP - C6OP - PRESSURE SWITCH ALARM / COMPRESSOR OIL	90
41.27	C1DT - C2DT - C3DT - C4DT - C5DT - C6DT HIGH COMPRESSOR DISCHARGE TEMPERATURE ALARM	90
41.28	C1TR - C2TR - C3TR - C4TR - C5TR - C6TR COMPRESSOR OVERLOAD ALARM	91
41.29	B1DF - B2DF DEFROST ALARM	91
41.30	B1CU - B2CU UNLOADING DISABLED FROM HIGH CONDENSING TEMPERATURE / PRESSURE IN CHILLER	91
41.31	B1CU - B2CU: UNLOADING FROM LOW CONDENSING TEMPERATURE / PRESSURE IN HEAT PUMP	91
41.32	B1RC - B2RC RECOVERY DISABLED FROM HIGH CONDENSING TEMPERATURE/PRESSURE IN CHILLER	92
41.33	B1PH - B2PH: PUMP DOWN STOP ALARM FROM PRESSURE SWITCH / LOW PRESSURE SWITCH	92
41.34	B1PL - B2PL ALARM DURING THE PUMP DOWN START-UP FROM PUMP DOWN PRESSURE SWITCH / LOW PRESSURE TRANSDUCER	92
41.35	C1MN - C2MN - C3MN - C4MN - C5MN - C6MN COMPRESSOR MAINTENANCE	92
41.36	AEP1 - AEP2 PUMP/ SUPPLY FAN MAINTENANCE	92
41.37	ACP1 - ACP1 CONDENSER PUMP MINTENANCE	94
41.38	ALARM RELAY AND BUZZER	94
41.39	KEYBOARD ALARM	94
42	AUTOMATIC TO MANUAL ALARM PROCEDURE	94
43	TABLE OF THE OUTPUT STATUS IN ALARM CONDITION	95
43.1	ALARM: "A" TYPE AND CORRESPONDING OUTPUT OFF	95
43.2	ALARM: "A" TYPE AND CORRESPONDING OUTPUT OFF	96
43.3	ALARM: "A" TYPE AND CORRESPONDING COMPRESSOR OUTPUT OFF	97
44	BLACK-OUT	98
45	INSTALLING AND MOUNTING	98
45.1	PANEL CUT- OUT	98

45.2	PLEXIGLASS PROTECTION BOTTOM OPEN	98
45.3	PLEXIGLASS PROTECTION TOP OPEN	98
45.4	METAL FRONT FRAME	99
45.5	VERTICAL BOARDS VI620 – VI820 PANEL CUT-OUT	99
46	ELECTRICAL CONNECTIONS	100
47	ACCESSORIES	100
47.1	MONOPHASE FAN CONTROL: 230VAC AND CUT PHASE CONTROL	100
47.2	INVERTER: MICROFAN 380VAC UP TO 4KW OR 8KW	101
47.3	TRANSFORMER	101
48	TECHNICAL DATA	102

1 GENERAL ADVICE

- 1.1 PLEASE READ BEFORE USING THIS MANUAL
- · This manual is part of the product and should be kept near the instrument for easy and quick reference.
- · The instrument shall not be used for purposes different from those described hereunder. It cannot be used as a safety device.
- · Check the application limits before proceeding.
- 1.2 SAFETY PRECAUTIONS
- · Check the supply voltage is correct before connecting the instrument.
- · Do not expose to water or moisture: use the controller only within the operating limits avoiding sudden temperature changes with high atmospheric humidity to prevent formation of condensation
- · Warning: disconnect all electrical connections before any kind of maintenance.
- · The instrument must not be opened.
- · In case of failure or faulty operation send the instrument back to the distributor or to "Dixell s.r.l." (see address) with a detailed description of the fault.
- · Consider the maximum current which can be applied to each relay (see Technical Data).
- Ensure that the wires for probes, loads and the power supply are separated and far enough from each other, without crossing or intertwining.
- · Fit the probe where it is not accessible by the end user.
- · In case of applications in industrial environments, the use of mains filters (our mod. FT1) in parallel with inductive loads could be useful.

2 GENERAL FEATURES

iCHILL IC200L is an electronic controller for chiller unit applications having one or two circuits:

- Air/air
- Air/water
- Water/water
- Motocondensing

Additional features :

- Heat pump with gas reversibility
- Free cooling function
- Recovery function

2.1 MAIN FUNCTION

Chiller management:

- One circuit up to 4 compressors
- Two circuits with different compressor number per circuit
- Double circuit up to 6 compressors
- Screw compressors

Compressor start up:

- Direct
- Part winding
- Star - delta

Compressor Soft start:

- With step valve
- Automatic start-unloading (without load).
- External by-pass gas valve.

Capacity step control:

- Continuous control
- Step control
- Modulation control (screw compressors)

Thermoregulation of the compressors

- Time running hours
- Number of start-up per hour

Cooling liquid injection

- With dedicated PTC probe

High temperature alarm of the compressor discharge side

- With dedicated PTC probe

Complete management of two pump groups of the water side

- 2 pumps evaporator side
- 2 pumps condenser side

Display layout customizable

- Temperature
- Pressure
- Time / RTC in real time

Other display readings

- Safety digital inputs
- Compressors running hours
- Number of compressor start-up
- Pump running hours
- Delay counting to the next defrost
- Proportional output percentage status
- Compressors discharge temperature

Alarm reset with custom password

- Alarm list
- Compressor thermal protection alarm

Single circuit stand-by

- Circuit maintenance
- To work with only one circuit

Single compressor stand-by

- Compressor maintenance
- Compressor malfunction

Pump down management

- With dedicated pressure switch
- Low pressure switch
- Low pressure transducer

Unloading circuit

- High temperature of the evaporator inlet water
- High temperature of the condenser inlet water (unit with recovery)
- High condensing pressure

- Low evaporating pressure

Maintenance messages

- Compressors
- Evaporator pumps
- Condenser pumps

Auxiliary relays

- Two configurable relay outputs not depending from the control algorithm can be managed through NTC, PTC or pressure probes.

Weekly Energy saving

- Three different time bands per day (only with RTC onboard)
- From digital input

Weekly ON/OFF:

- Three different time bands per day (only with RTC onboard)

Dynamic setpoint:

- Determined by analogue NTC input or 4÷20mA current input.

Change over :

- Automatic chiller or heat pump functioning depending from NTC analogue input.

Remote OFF:

- From configurable digital input.

Remote change over:

- From configurable digital input.

Hot start :

- Air / air unit

Defrost management:

- Combined control with temperature and pressure
- Forced defrost with low temperature of external air
- From configurable digital input
- Manual from keyboard

Boiler:

- For electrical integration heating or anti-freeze heaters

Two proportional outputs for condensing fan speed control (inverter or phase cut) with configurable signal:

- PWM
- 0÷10Volt
- 4÷20mA

Four proportional control outputs 0÷10V or ON/OFF

- To control the dumper in free cooling or recovery
- To control an external relay

Complete alarm management

- Internal Data logger up to 100 events

Supervisor / tele assistance/ monitoring

- TTL output for XJ485 interface (Mod #Bus protocol) for XWEB300 / XWEB3000 Dixell monitoring system for local and remote control

Up to 2 remote terminals with display read-out customizable

- With NTC ambient temperature probe

3 IC200 L TABLE OF THE FEATURES

FEATURES	IC260L	IC261L	IC280L	IC281L
	CHILLER WITH HEAT PUMP		CHILLER WITH HEAT PUMP, FREE COOLING AND HEATING RECOVERY	
FRONTPANEL KEY BUTTONS				
6	●	●		
8			●	●
OUTPUT RELAYS				
10	●		●	
14		●		●
DIGITAL INPUTS				
18	configurable	configurable	configurable	configurable
PROBE INPUTS				
10 NTC - PTC - 4÷20mA - 0 ÷ 5Volt	configurable	configurable	configurable	configurable
PROPORTIONAL OUTPUTS				
Two PWM outputs for condensing fan	●	●	●	●
Two 0÷10V o 4÷20mA for condensing fan	configurable	configurable	configurable	configurable
Four 0÷10V outputs for Free cooling and Heating recovery, or to drive an external relay	configurable	configurable	configurable	configurable
OTHER OUTPUTS				
TTL / RS – 485 with Mod-Bus-Rtu protocol	●	●	●	●
Output for remote keyboard VI620 (up to 2 boards together)	●	●		
Output for remote keyboard VI820 (up to 2 boards together)			●	●
POWER SUPPLY				
12 Vac/dc (+15%;-10%)	●	●	●	●
24 Vac/dc (± 10%)	opt	opt	opt	opt
TOP DISPLAY				
± 3 led with decimal point	●	●	●	●
BOTTOM DISPLAY				
± 4 led with decimal point	●	●	●	●
OTHERS				
Internal RTC	opt	opt	opt	opt
Buzzer	opt	opt	opt	opt

- configurable = configurable through parameter
- opt = optional
- ● = default
- free cooling (IC280L / IC281L only)
- Heating recovery (IC280L / IC281L only)

4 USER INTERFACE

4.1 FUNCTION OF THE LEDs OF THE KEY BUTTONS

Use of the led on the IC260L / IC261L models

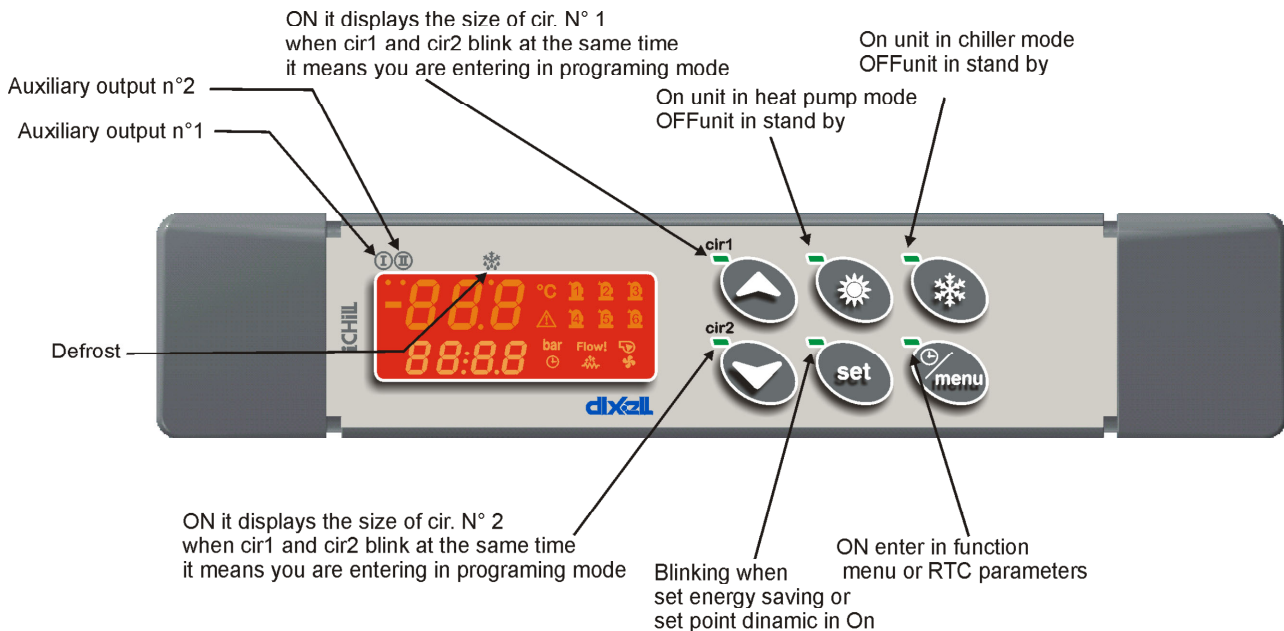

Use of the led on the IC260L / IC261L metal models

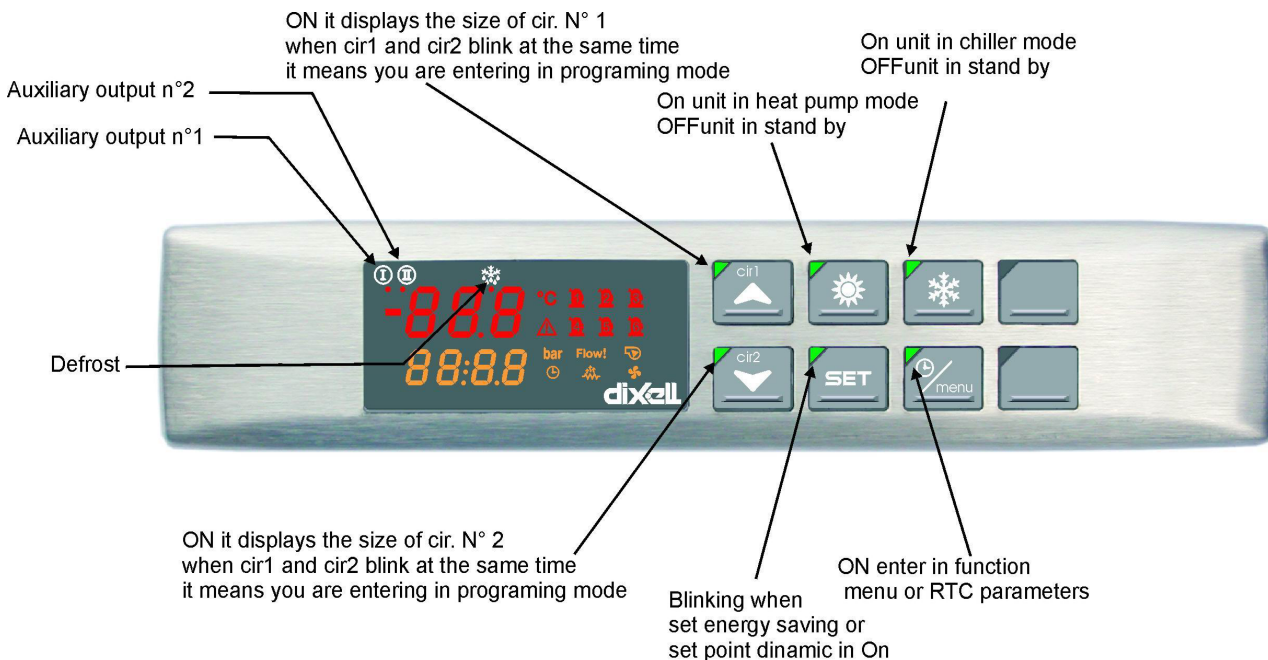

Use of the led on the models IC280L / IC281L

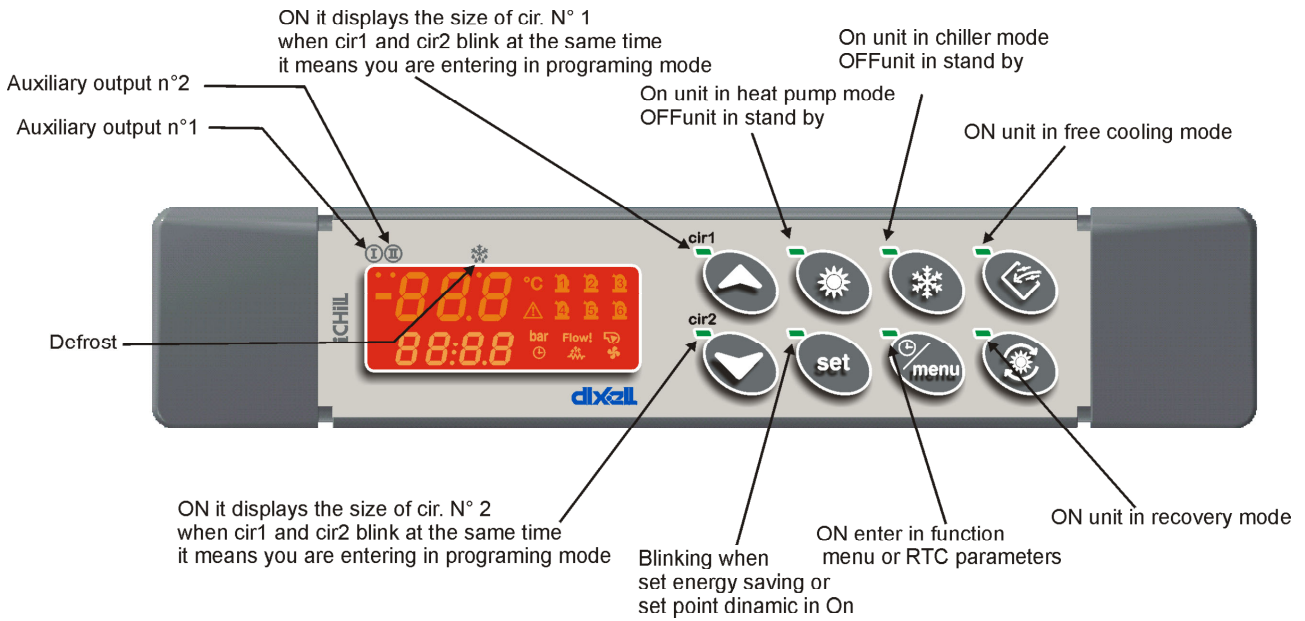

Use of the led on the metal models IC280L / IC281L

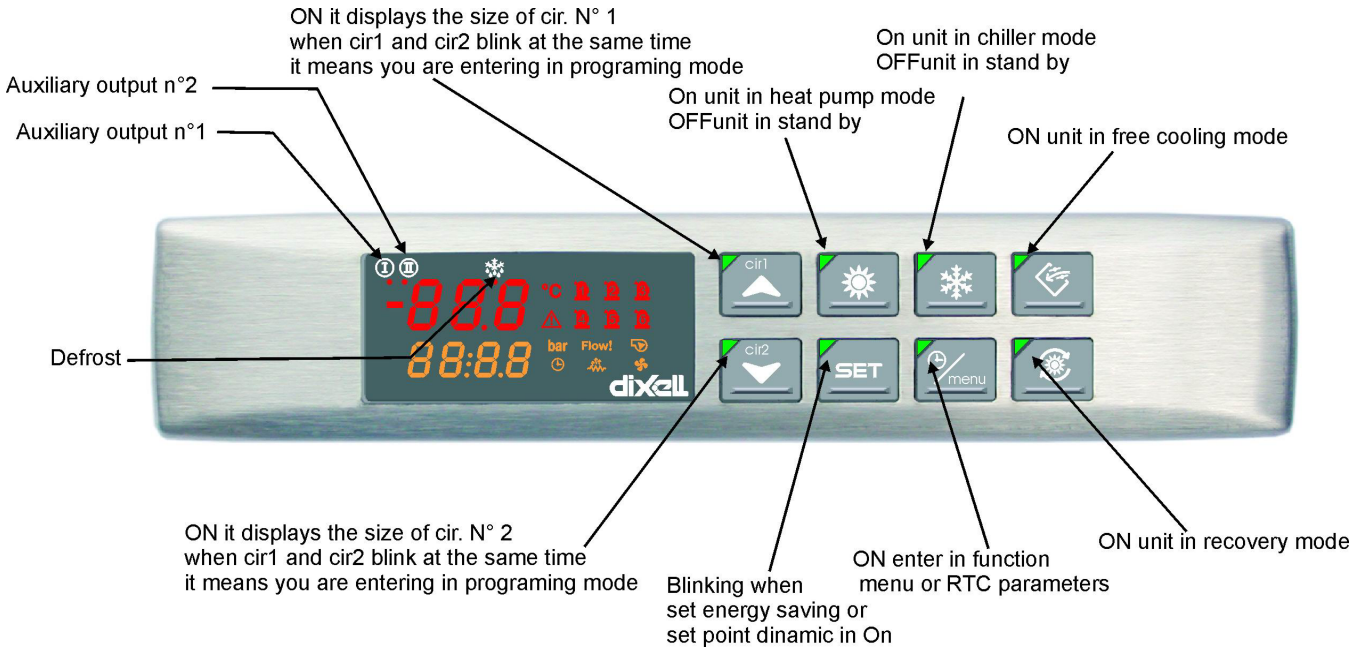



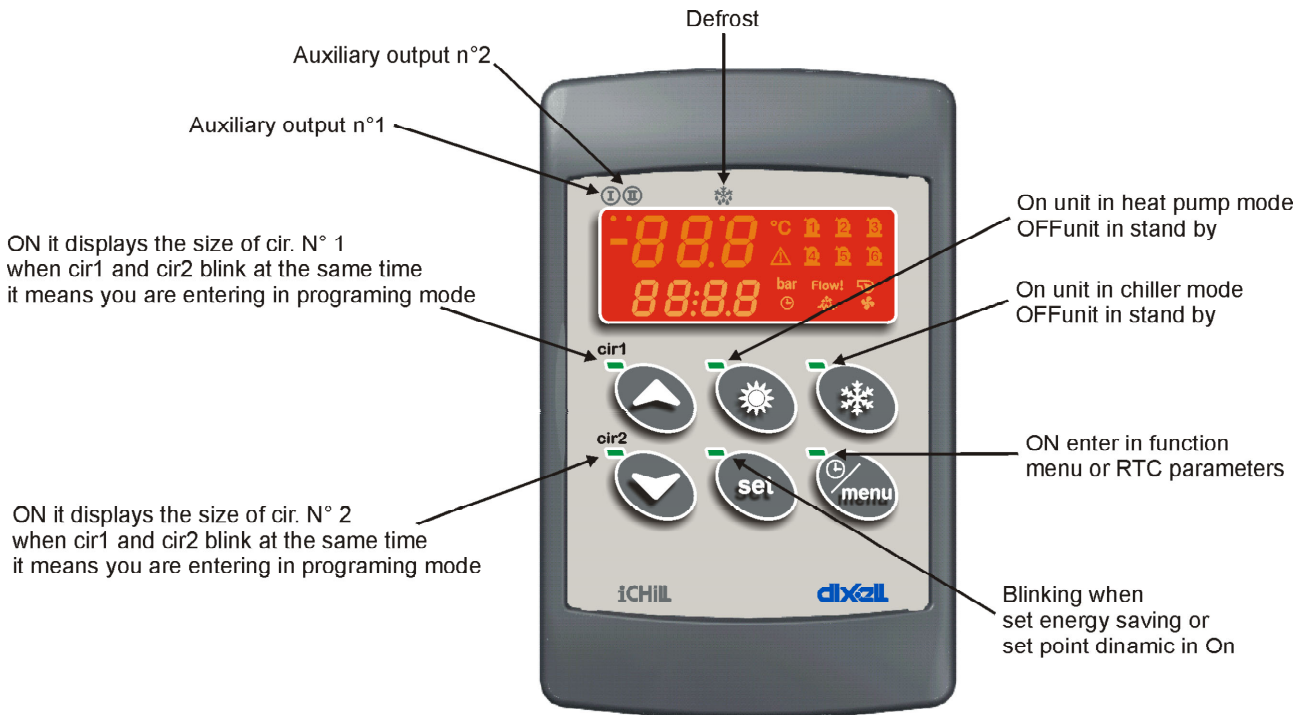



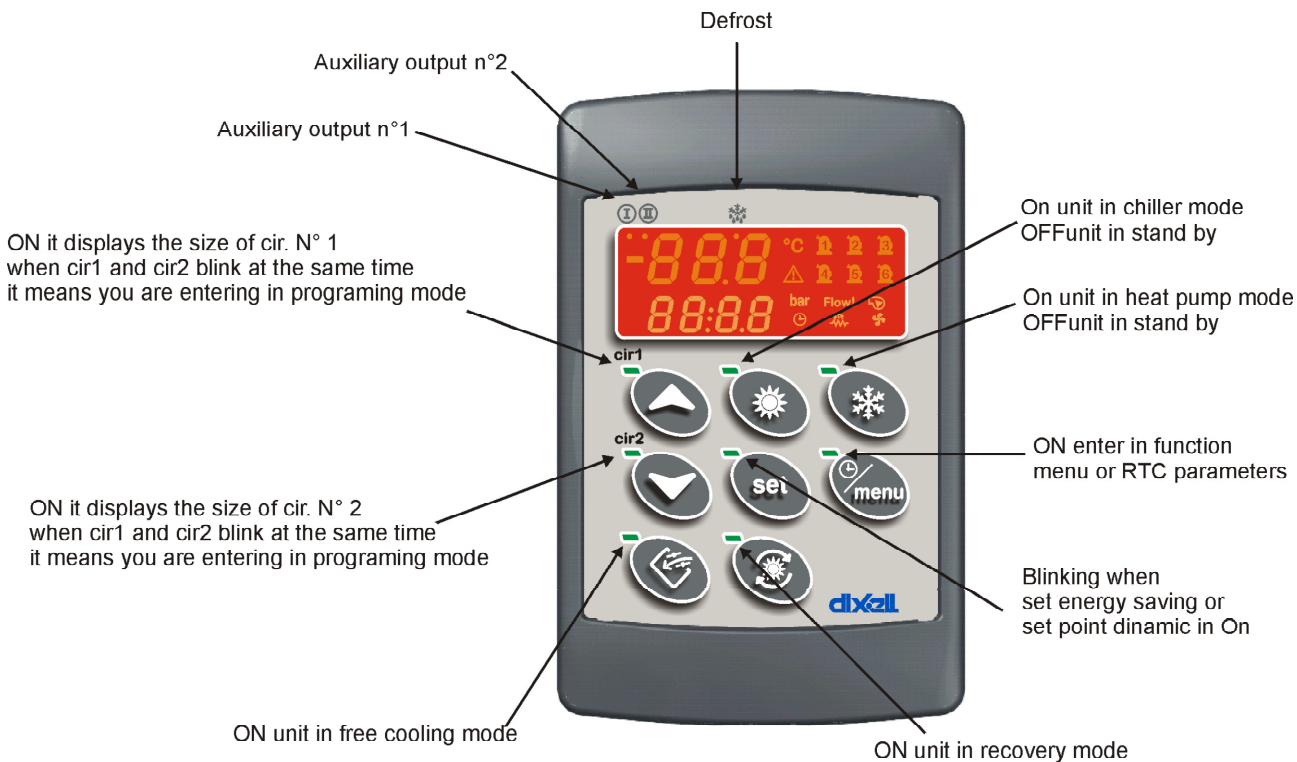

4.2 USE OF THE LED ON THE MODELS VI620 - VI620S REMOTE PANELS





4.3 USE OF THE LED ON THE MODELS VI820 - VI820S REMOTE PANELS





4.4 KEY FUNCTION

KEY	ACTION	FUNCTION
	Push and release	Show chiller set point SetC and heat pump SetH
	Push once	In chiller or heat pump if the Energy saving or the Dynamic setpoint are enabled it shows the real setpoint Setr , the led is blinking.
	Push for 3 seconds the release	Change between chiller / heat pump
	During the programming: push one time	Select a parameter or confirm a value
	Push once with probe label showed on the bottom display	Change between the read-out of the circuit 1 and the circuit 2 and viceversa
 UP KEY	Push once	Select the readings of the first circuit
	Pushing once during the programming	To change the parameter code or value
	Push for 1 second during the programming	1 time shows the Pr2 programming level 2 time shows the Pr3 programming level
 TASTO DOWN	Push once	Select the readings of the second circuit
	Pushing one time during the programming	To change the parameter code or value
	Push once	Turn the chiller on, if the unit is on led is on The led is blinking if there is a power on delay or during the pump down
	Push once	Turn the heat pump on, if the unit is on led is on The led is blinking if there is a power on delay or during the pump down
	Push once	enter the function Menu
	Push for 3 seconds	To set RTC parameters (if the RTC is inside)
	Pushing once during the programming	To exit from a group of parameter
	Push once	Start the heating recovery of the chiller unit, with recovery active the led is on
	Push once	Start the free cooling of chiller unit, with free cooling active the led is on

















4.5 KEY COMBINANTION

KEY	ACTION	FUNCTION
cir2 	Push for 3 seconds together	Enter the programming
	In Pr3 level: push SET and the push DOWN key	Select the parameter level visibility Pr1 / Pr2 / Pr3
cir1 	Push once together	Exit the programming
	Push 5 seconds (heat pump with ok condition)	Manual defrost
	In Pr3 programming level Push SET and then the MENU key	In Pr3 defines if the parameter can be changed or not in the other levels.

4.6 LED AND ICONS

ICON	LED	FUNCTION
	ON	Auxiliary relay #1 active
	OFF	Auxiliary relay #1 not active
	ON	Auxiliary relay #2 active
	OFF	Auxiliary relay #2 not active
	BLINKING	Defrost delay counting active
	ON	Defrost
	OFF	Defrost end

4.7 DISPLAY AND ICONS

ICON	MEANING / FUNCTIONNING
	Celsius degrees: ON for temperature measurements of probe values or parameters
	Fahrenheit degrees: ON for temperature measurements of probe values or parameters
	Bar: ON for pressure measurements of probe values, setpoint or parameters
	Psi: ON for pressure measurements of probe values, setpoint or parameters
	ON = compressor 1 active Blinking = compressor 1 delay counting
	ON = compressor 2 active Blinking = compressor 2 delay counting
	ON = compressor 3 active Blinking = compressor 3 delay counting
	ON = compressor 4 active Blinking = compressor 4 delay counting
	ON = compressor 5 active Blinking = compressor 5 delay counting
	ON = compressor 6 active Blinking = compressor 6 delay counting
	General alarm: blinking if there is an alarm not identified by an icon
	Anti freeze heaters/ integration heating / boiler: ON if the output is on
	Flow alarm/ (differential) pressure switch / supply fan thermal (air / air unit) : is blinking if the configuration of the digital input is active
	Real time clock: On when the bottom display show the RTC ON during the programming with time based parameter value In function menu indicates the defrost delay counting
	Water pump: On if at least one of the four configurable pump group is on
	Condenser fan: ON if at least one of the PWM or relay outputs for fan control is active

4.8 MEANING/ FUNCTIONING OF THE BOTTOM DISPLAY LED

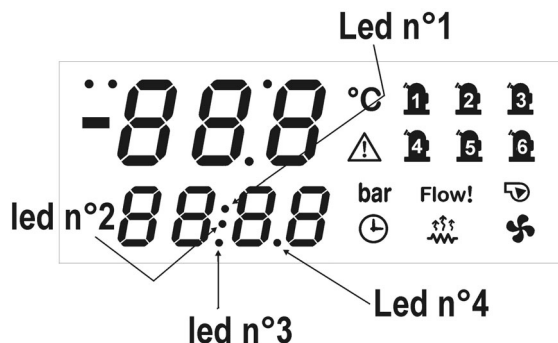

Led # 1 – 2 (With RTC)

If the bottom display shows the RTC the 1 and 2 leds are blinking.

Led # 1 – 2 In function Menu

During the time counting to the next defrost for one or both circuits the led 1 and 2 are blinking.

LED Parameter programming

In Pr2 level: led #3 indicates the visibility while the #1 and #2 show if the parameter can be modified or not.

In Pr3 level: led #3 and #4 indicate the visibility while the #1 and #2 show if the parameter can be modified or not.

5 REMOTE TERMINAL

The iCHILL can be connected with 2 remote terminals. Each remote terminal can have the NTC probe on board that is used to show the local temperature and also to control the temperature regulation.

for the connections use shielded cable for a maximum length of 150mt. In case of no communication between the instrument and the remotes the upper display shows "noL" (no link).

Mod. VI620 - VI620S can be connected to IC260L – IC261L

Mod. VI820 - VI820S can be connected to IC280L – IC281L

Use the connection cable **CAB/CJ30** (2x0.2 mm²) to interface the ichill connector to the shielded wire.

6 FIRST INSTALLING

6.1 ON BOARD CLOCK (OPTIONAL)

Giving power supply the bottom display shows "rtc" alternated with a temperature or pressure value: **It is necessary to set the RTC.**

If the probes are not connected the display shows the corresponding probe alarm messages. In this situation the RTC setup and the programming are available.

ATTENTION

The RTC function is an optional and it is not possible to update the instrument but it is necessary to order the instrument already complete of this features.

With power failure the RTC back-up battery maximum duration is 1 week. After this period it is necessary to setup the clock again.

6.2 RTC SETUP

1. Push **M** key for 3 seconds until the bottom display shows "**Hour**" and the top display shows its value.
2. Push **SET** one time: the value is blinking.
3. Use the Up and Down keys to adjust it. Push **SET** one time to confirm; automatically the display shows next parameter.
4. Repeat the operations 2. 3. and 4. for all the RTC parameters:
 - **Min**: minutes (0+60)
 - **UdAy**: day of the week (**Sun** = Sunday, **Mon** =Monday, **tuE** =Tuesday, **UEd** = Wednesday, **tHu** = Thursday, **Fri** =Friday, **SAT** =Saturday)
 - **dAy**: day of the month (0+31)
 - **Mnth**: month (1+12)
 - **yEAR**: year (00+99)

7 WIRING CONNECTIONS

7.1 HARDWARE RESOURCES FOR IC260L - IC280L MODELS

- 10 digital outputs (relays)
 - 18 digital inputs (free of voltage)
 - 10 analogue inputs: NTC probes or through configuration 6 NTC / PTC and 4 pressure transducer 4+20mA or ratio-metric 0+ 5.0Volt
 - 6 modulating outputs
 - 1 output for remote panel (max 2 remote panels)
 - 1 TTL output for "Hot Key 64" connection or for XJ485, interface module for monitoring system, connection.
- MAX current on the relay contacts relè 5(2)A 250V - MAX common current 12A 250V

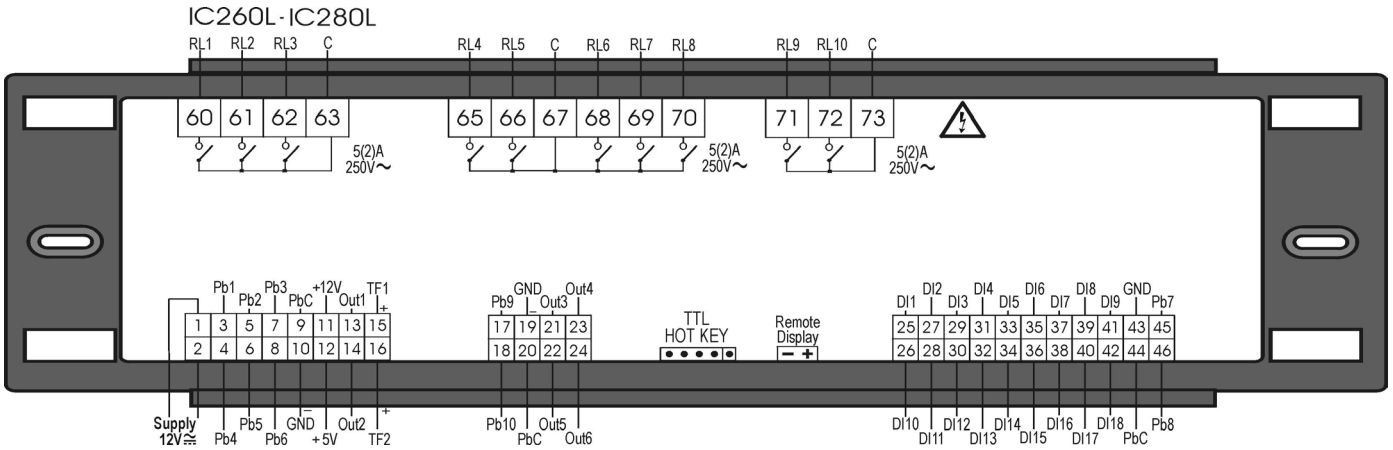

7.2 HARDWARE RESOURCES FOR IC261L - IC281L MODELS

- 14 digital outputs (relays)
 - 18 digital inputs (free of voltage)
 - 10 analogue inputs: NTC probes or through configuration 6 NTC / PTC and 4 pressure transducer 4+20mA or ratio-metric 0+ 5.0Volt
 - 6 modulating outputs
 - 1 output for remote panel (max 2 remote panels)
 - 1 TTL output for "Hot Key 64" connection or for XJ485, interface module for monitoring system, connection.
- MAX current on the relay contacts relè 5(2)A 250V - MAX common current 12A 250V

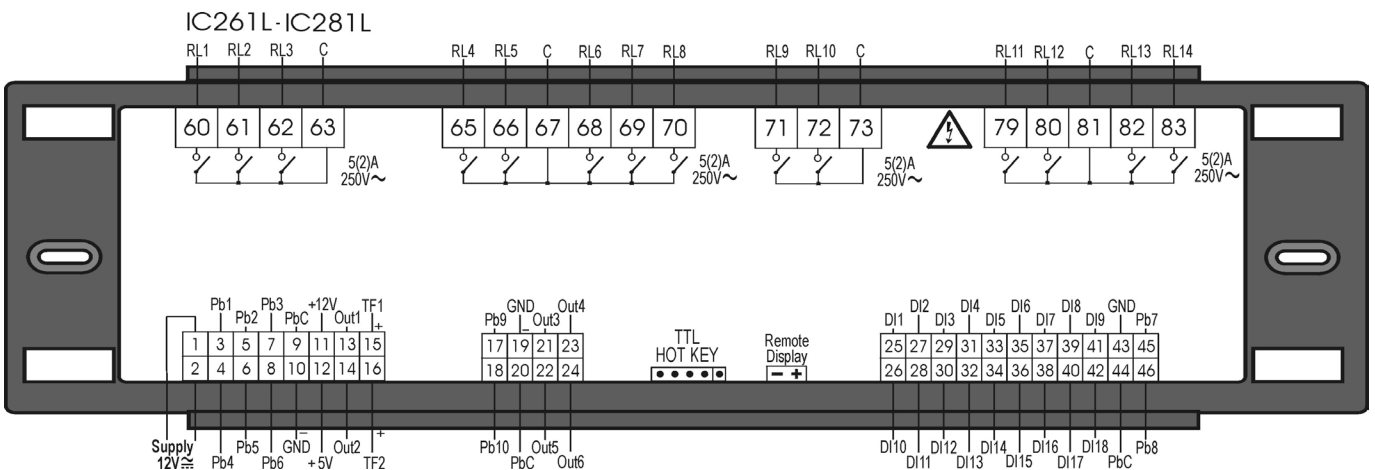

7.3 ANALOG INPUTS NTC – PTC PROBES

PbC = Common terminal

IC260L - IC261L - IC280L - IC281L

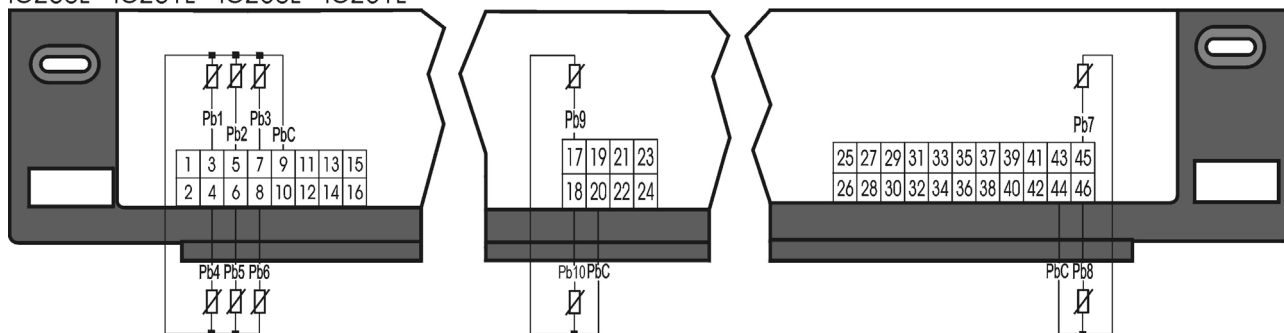

7.4 DIGITAL INPUTS

GND = Common terminal

IC260L - IC261L - IC280L - IC281L

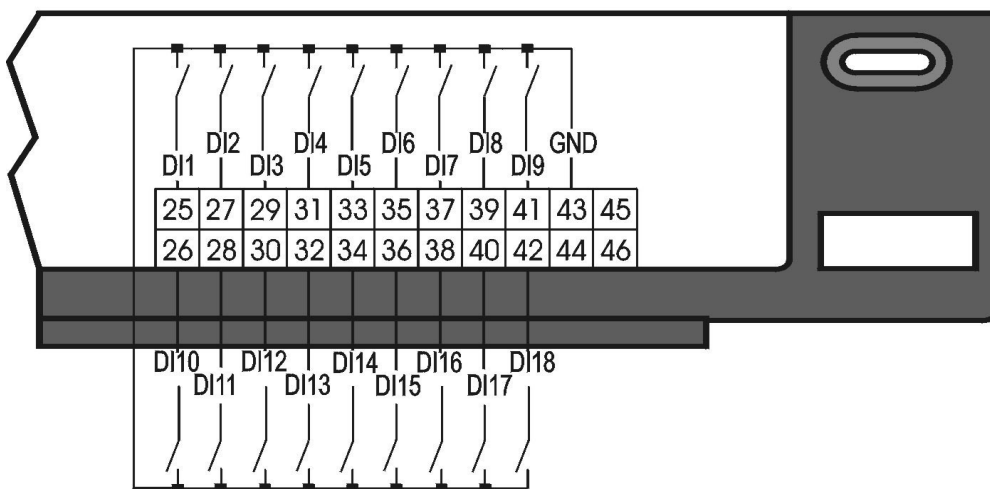

7.5 ANALOG INPUT FOR PRESSURE TRANSDUCER Pp30 (4 ÷ 20mA SIGNAL)

Using 4÷20mA pressure transducer set the Parameter CF07 = 0 / 1

IC260L - IC261L - IC280L - IC281L

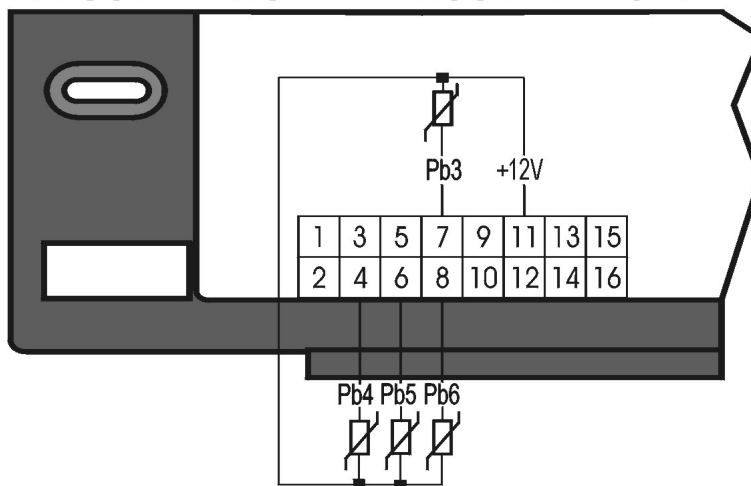

7.6 ANALOG INPUT FOR PRESSURE RATIOMETRIC TRANSDUCER PPR30 (0 ÷ 5V SIGNAL)

Using 5V ratio-metric pressure transducer set the Parameter CF07 = 2 / 3

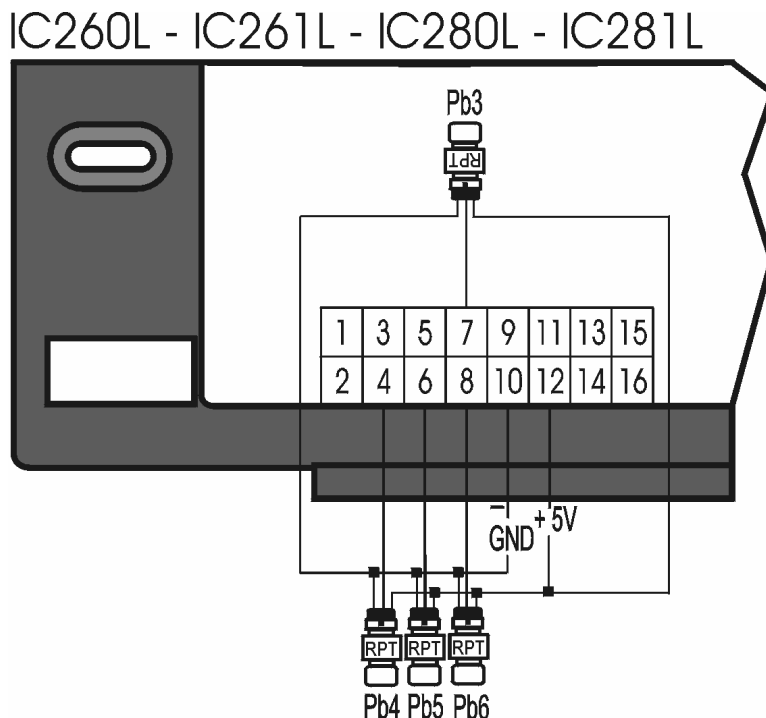

7.7 PWM OUTPUT FOR CONDENSING FAN SPEED CONTROL

With only one condensing circuit configured the TF1 / TF2 outputs work together. The PWM signal can control the cut phase controllers for the following mono-phase models:

- Mod. XV05PK mono-phase , cut phase control 500 Watt (2A)
- Mod. XV10PK mono-phase , cut phase control 1000 Watt (4A)
- Mod. XV22PK mono-phase , cut phase control 2200 Watt (9A)

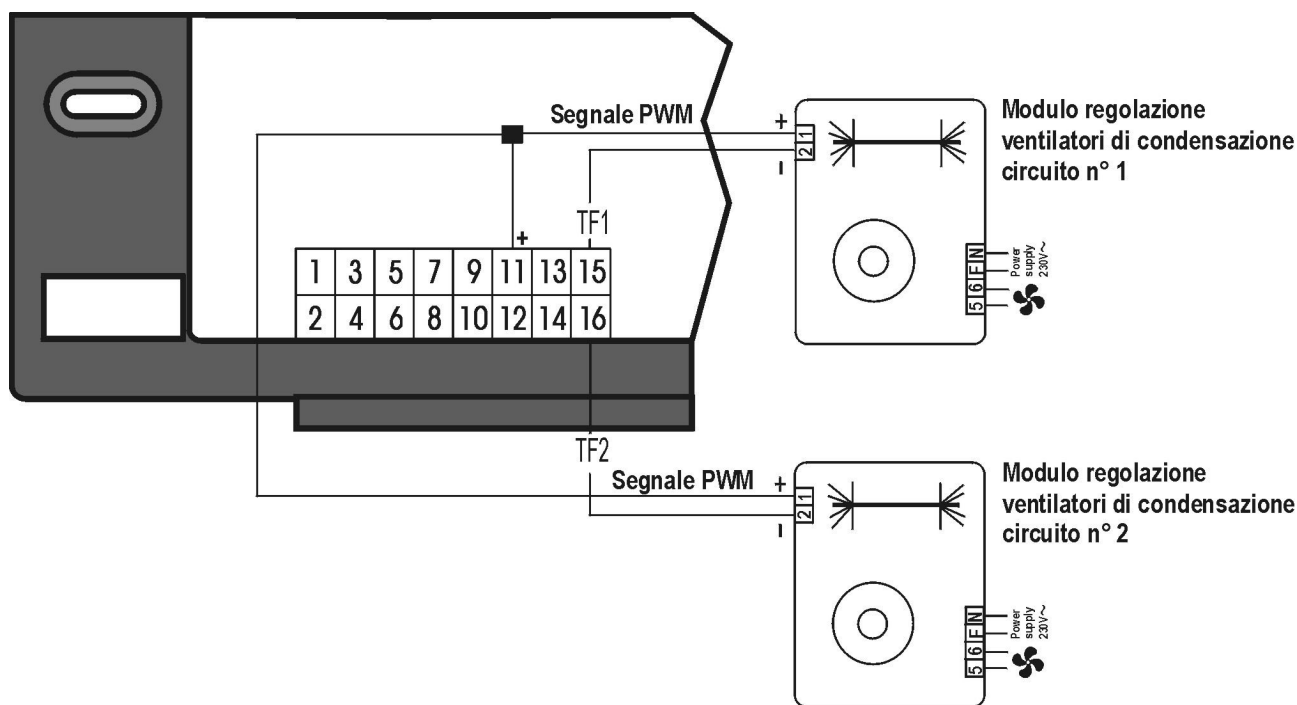

7.8 FAN CONDENSING CONTROL: 0 ÷ 10VDC OUTPUTS

With only one condensing circuit configured, the Out1 / Out2 outputs work together giving the same signal. With the two 0 – 10V outputs the iCHILL can drive a mono-phase or three-phase controllers (such as the Dixell inverter models XV340GS) up to 8KW.

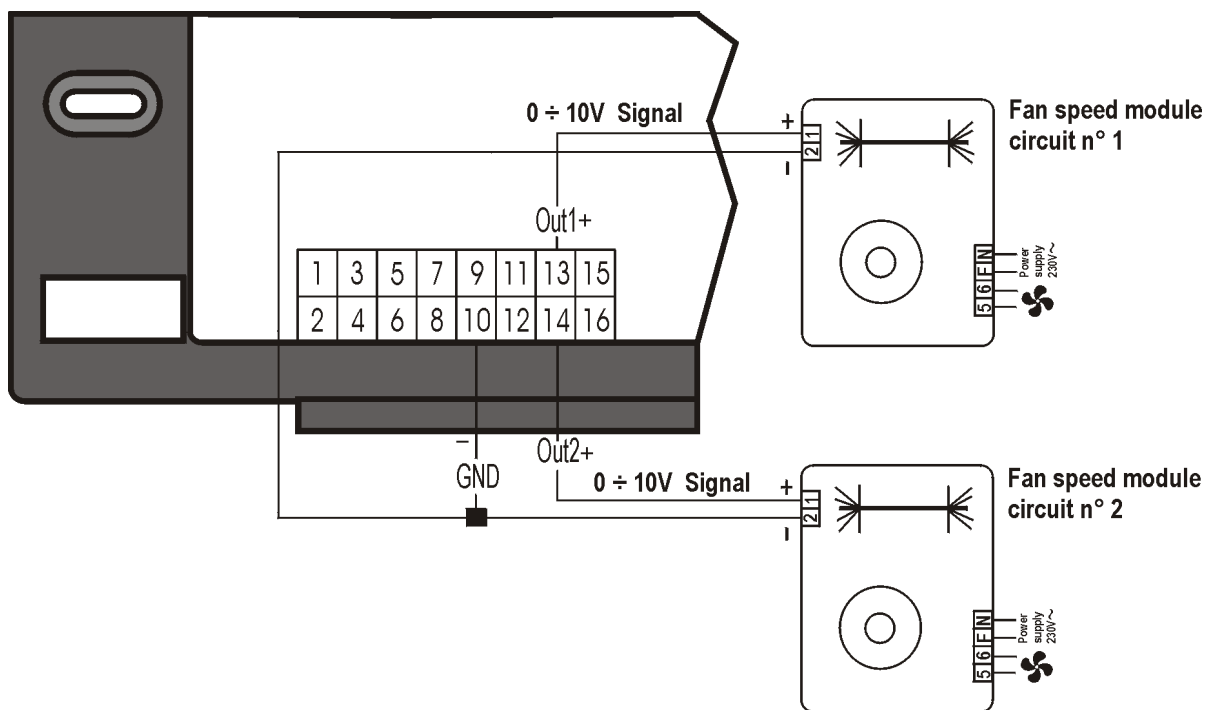

7.9 FAN CONDENSING CONTROL WITH 4÷20mA OUTPUT

With only one condensing circuit configured, the Out1 / Out2 outputs work together giving the same signal. With the 4..20mA outputs the iCHILL can drive a mono-phase or three-phase controllers (such as the Dixell inverter models XV340GS) up to 8KW.

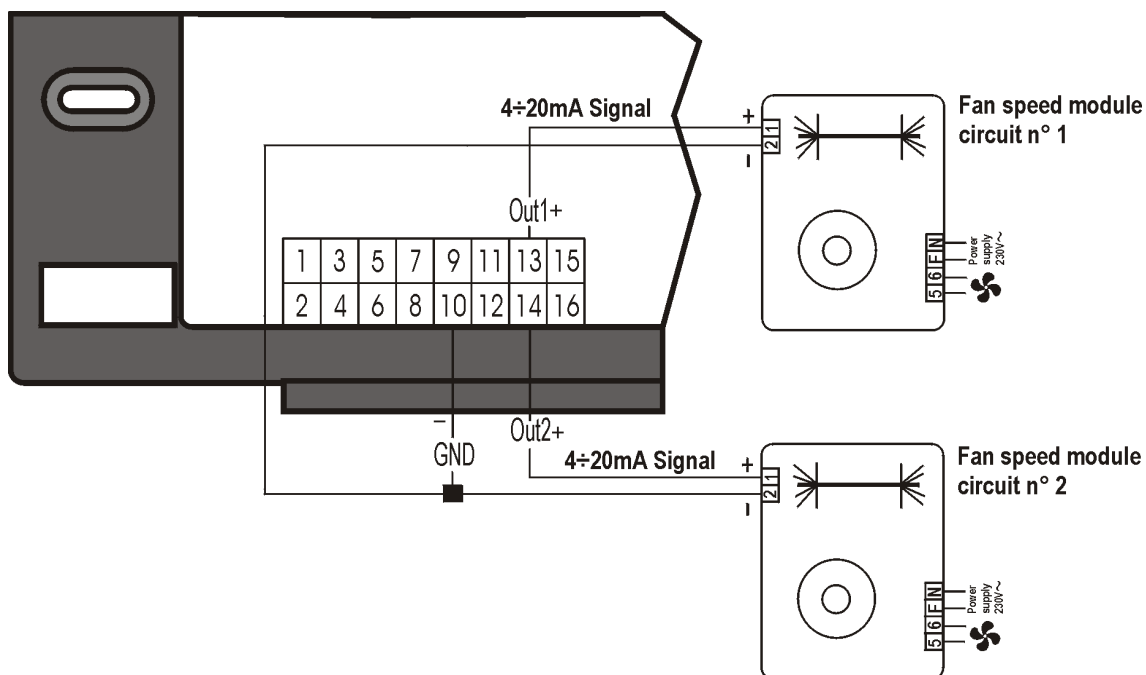

7.10 PROPORTIONAL OUTPUTS 0 ÷ 10V DUMPER CONTROL

GND = common

IC260L - IC261L - IC280L - IC281L

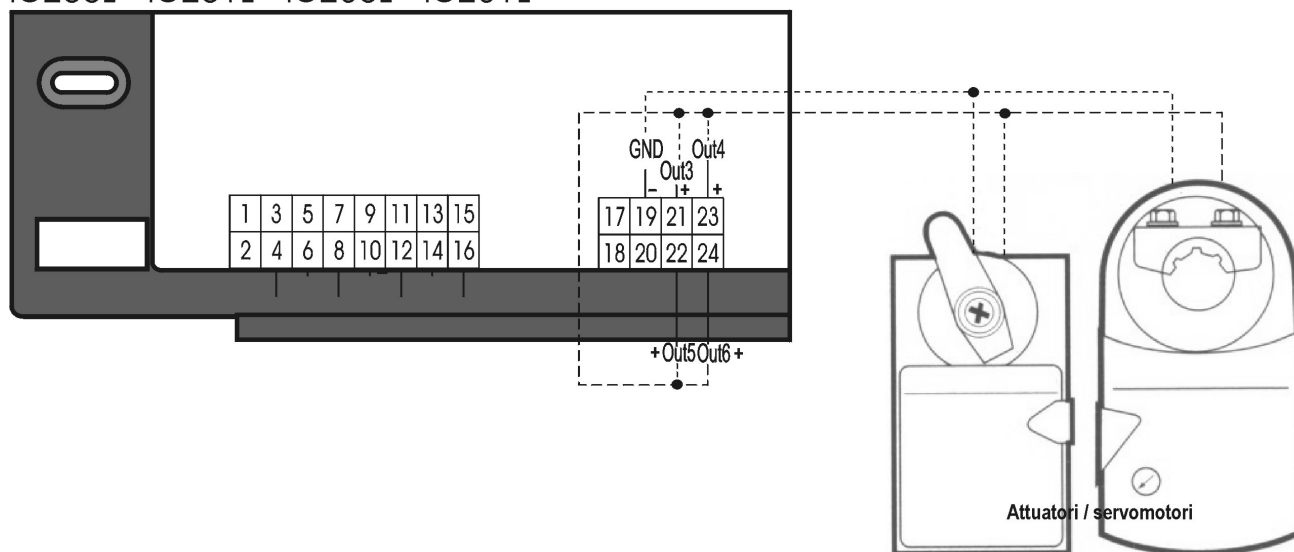

7.11 PROPORTIONAL OUTPUTS CONFIGURED FOR AUX RELAY CONTROL

GND = common

By parameter programming is possible to connect a 12 volt, 40mA relay.

IC260L - IC261L - IC280L - IC281L

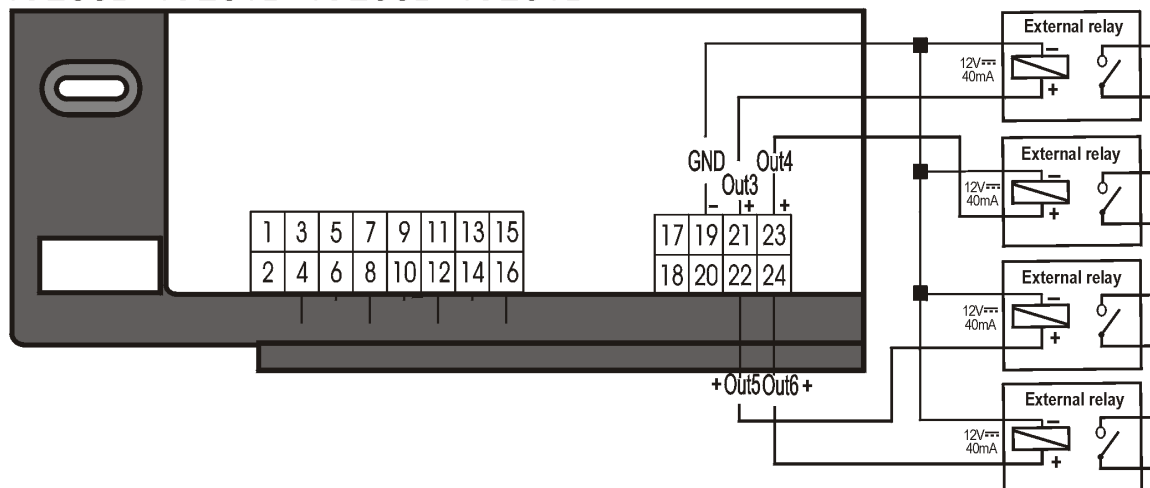

7.12 HOT KEY 64 CONNECTION

The programming HOT KEY 64 allows to upload or download a copy of the parameters of the instrument (see HOT KEY paragraph).

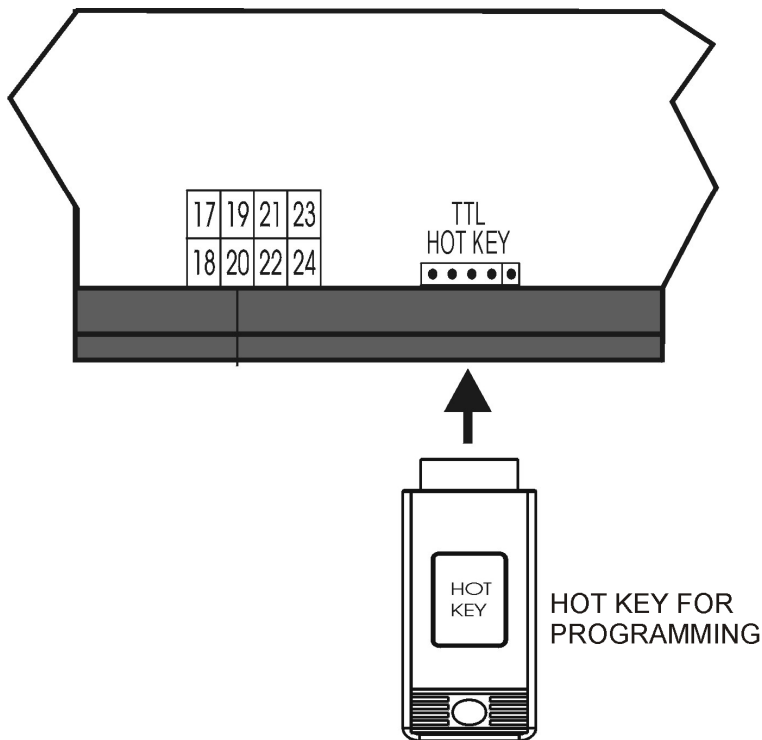

7.13 XJ485 CONNECTION

The XJ485 interface is a converter between the RS485 and the TTL connector output. The RS485 uses two terminals (+) and (-) that must be connected respecting the polarity to build the serial line. Use the CAB/RS02 to connect the XJ485 interface to the TTL connector.

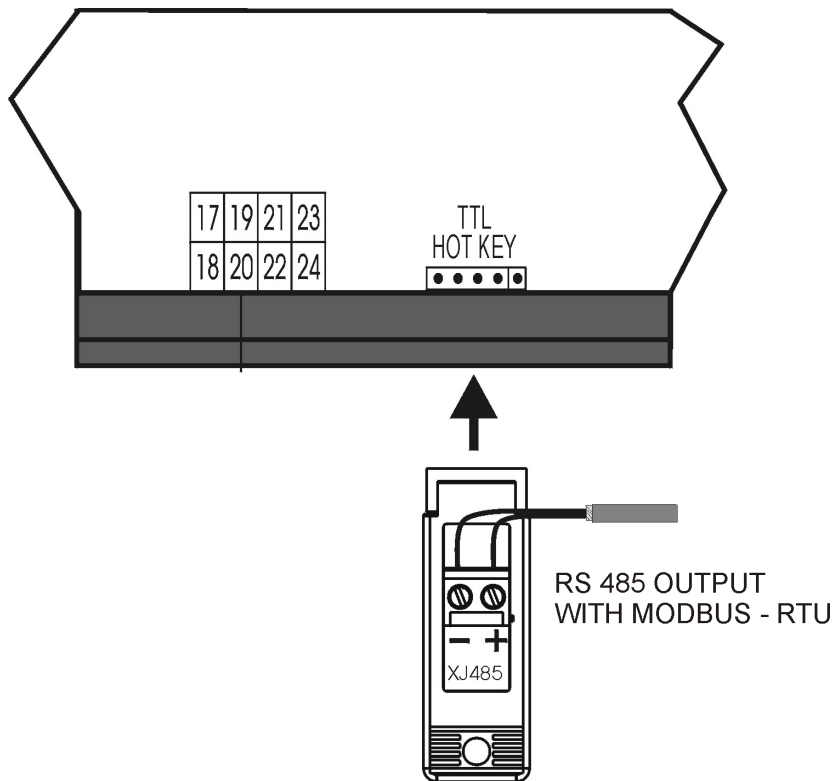

7.14 REMOTE PANELS VI620 – VI820

The instrument receives up to two remote panels. Using the remote panels provided with the ambient NTC probe the display measurement, and the control can be managed directly by this probe. Use shielded cable for the connection up to 150mt maximum. In case of communication failure the upper display shows “noL” (no link).

Use the CAB/CJ30 to interface the ichill connector to the shielded cable.

- Remote panel VI620 for models IC260L – IC261L
- Remote panel VI820 for models 200 L IC280L – IC281L

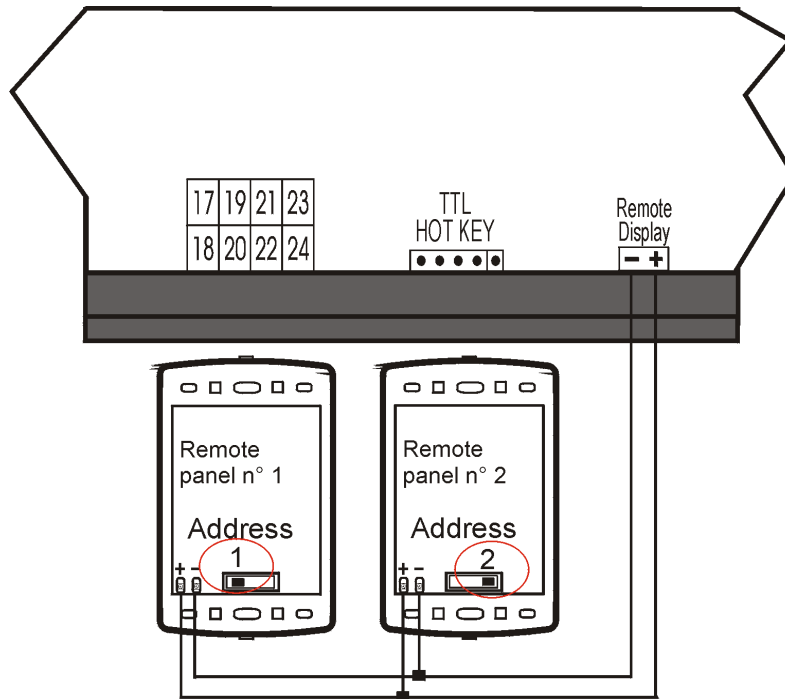

8 ANALOG AND DIGITAL OUTPUT CONFIGURATION

8.1 ANALOG INPUT PB1 - PB2 - PB7 - PB8 - PB9 - PB10

Parameters involved:

- CF08 = Configuration PB1
- CF09 = Configuration PB2
- CF14 = Configuration PB7
- CF15 = Configuration PB8
- CF16 = Configuration PB9
- CF17 = Configuration PB10

0. Not enabled
1. Temperature probe **PTC** for compressor #1 discharge
2. Temperature probe **PTC** for compressor #2 discharge
3. Temperature probe **PTC** for compressor #3 discharge
4. Temperature probe **PTC** for compressor #4 discharge
5. Temperature probe **PTC** for compressor #5 discharge
6. Temperature probe **PTC** for compressor #6 discharge
7. Temperature probe **NTC** for evaporator inlet
8. Temperature probe **NTC** for evaporator #1 outlet
9. Temperature probe **NTC** for evaporator #2 outlet
10. Temperature probe **NTC** for common evaporator outlet
11. Temperature probe **NTC** for common hot water condenser / recovery inlet
12. Temperature probe **NTC** for hot water of the condenser / recovery circuit #1 inlet
13. Temperature probe **NTC** for hot water of the condenser / recovery circuit #2 inlet
14. Temperature probe **NTC** for hot water of the condenser / recovery circuit #1 outlet
15. Temperature probe **NTC** for hot water of the condenser / recovery circuit #2 outlet
16. Temperature probe **NTC** for hot water of the condenser / recovery common outlet
17. Temperature probe **NTC** for free cooling water inlet circuit
18. Temperature probe **NTC** for free cooling external air temperature
19. Temperature probe **NTC** for dynamic setpoint external air / boiler / change over
20. Temperature probe **NTC** for combined defrost circuit #1
21. Temperature probe **NTC** for combined defrost circuit #2
22. Temperature probe **NTC** for auxiliary output #1

23. Temperature probe **NTC** for auxiliary output #2
24. Temperature probe **NTC** for condensing circuit #1
25. Temperature probe **NTC** for condensing circuit #2

After the number 25 the display configuration can be selected from **o 1** to **c62** that allows to set an analogue input as digital input (see polarity of the digital input/outputs).

8.2 ANALOG INPUT CONFIGURATION PB3 - PB4 - PB5 - PB6

Parameter involved:

CF10 = Configuration PB3

CF11 = Configuration PB4

CF12 = Configuration PB5

CF13 = Configuration PB6

- 0 Not enabled
- 1 Temperature probe **PTC** for compressor 1 discharge
- 2 Temperature probe **PTC** for compressor 2 discharge
- 3 Temperature probe **PTC** for compressor 3 discharge
- 4 Temperature probe **PTC** for compressor 4 discharge
- 5 Temperature probe **PTC** for compressor 5 discharge
- 6 Temperature probe **PTC** for compressor 6 discharge
- 7 Temperature probe **NTC** for evaporator inlet
- 8 Temperature probe **NTC** for evaporator outlet # 1
- 9 Temperature probe **NTC** for evaporator outlet # 2
- 10 Temperature probe **NTC** for common evaporator outlet
- 11 Temperature probe **NTC** for common hot water condenser / recovery inlet
- 12 Temperature probe **NTC** for hot water condenser / recovery inlet circuit #1
- 13 Temperature probe **NTC** for hot water condenser / recovery inlet circuit #2
- 14 Temperature probe **NTC** for hot water condenser / recovery outlet circuit #1
- 15 Temperature probe **NTC** for hot water condenser / recovery outlet circuit #2
- 16 Temperature probe **NTC** for hot water condenser / recovery common outlet circuit
- 17 Temperature probe **NTC** for free cooling water inlet
- 18 Temperature probe **NTC** for free cooling external air
- 19 Temperature probe **NTC** for external air dynamic setpoint/ boiler / change over
- 20 Temperature probe **NTC** for combined defrost circuit #1
- 21 Temperature probe **NTC** for free cooling water inlet #2
- 22 Temperature probe **NTC** for auxiliary output #1
- 23 Temperature probe **NTC** for auxiliary output #2
- 24 Condenser probe circuit 1 (temperature **NTC** / pressure **4÷20 mA** / ratio-metric **0÷ 5Volt**)
- 25 Condenser probe circuit 2 (temperature **NTC** / pressure **4÷20 mA** / ratio-metric **0÷ 5Volt**)
- 26 Evaporator pressure probe circuit 1 (pressure **4÷20 mA** / ratio-metric **0÷ 5Volt**)
- 27 Evaporator pressure probe circuit 1 (pressure **4÷20 mA** / ratio-metric **0÷ 5Volt**)
- 28 Auxiliary output 1 pressure probe control (**4÷20 mA** / ratio-metric **0÷ 5Volt**).
- 29 Auxiliary output 2 pressure probe control (**4÷20 mA** / ratio-metric **0÷ 5Volt**).
- 30 Dynamic setpoint pressure probe (**4÷20 mA**)

After the number 30 the display read-out goes from **o 1** to **c62** that allows to set an analogue input as digital input (see polarity input of digital inputs).

8.3 DIGITAL INPUT CONFIGURATION ID1 – ID18

Parameters involved:

CF36 = Configuration ID1...**CF53** = Configuration ID18

0. Not enabled
1. Remote ON / OFF
2. Remote chiller / heat pump
3. Flow switch/ Supply fan overload
4. Flow switch of heated side
5. Antifreeze heater circuit 1
6. Antifreeze heater circuit 2
7. High pressure switch circuit # 1
8. High pressure switch circuit 2
9. Low pressure switch circuit 1
10. Low pressure switch circuit 2
11. Compressor 1 high pressure
12. Compressor 2 high pressure
13. Compressor 3 high pressure
14. Compressor 4 high pressure
15. Compressor 5 high pressure
16. Compressor 6 high pressure
17. Compressor 1 overload
18. Compressor 2 overload
19. Compressor 3 overload
20. Compressor 4 overload
21. Compressor 5 overload
22. Compressor 6 overload
23. Condenser fan overload of circuit 1
24. Condenser fan overload of circuit 2
25. Condenser fan overload of circuit 1 and 2 (comun)

26. Water pump overload of evaporator 1
27. Water support pump overload of evaporator
28. Water pump overload of condenser 1
29. Water support pump overload of condenser
30. Recovery request for circuit 1
31. Recovery request for circuit 2
32. Defrost end of circuit 1
33. Defrost end of circuit 2
34. Energy Saving
35. Pressure switch / compressor 1 oil
36. Pressure switch / compressor 2 oil
37. Pressure switch / compressor 3 oil
38. Pressure switch / compressor 4 oil
39. Pressure switch / compressor 5 oil
40. Pressure switch / compressor 6 oil
41. Pump down pressure switch of circuit 1
42. Pump down pressure switch of circuit 2
43. Generic alarm from digital input with stop regulation
44. Digital input of thermoregulation request (motocondensing unit)
45. Digital input of cooling request (motocondensing unit)
46. Digital input of heating request (motocondensing unit)
47. Request / partialization 1 of compressor 1 (motocondensing unit)
48. Request / partialization 2 of compressor 1 (motocondensing unit)
49. Request / partialization 3 of compressor 1 (motocondensing unit)
50. Request compressor #2
51. Request / partialization 1 of compressor 2 (motocondensing unit)
52. Request / partialization 2 of compressor 2 (motocondensing unit)
53. Request / partialization 3 of compressor 2 (motocondensing unit)
54. Request compressor #3
55. Request / partialization 1 of compressor 3 (motocondensing unit)
56. Request / partialization 2 of compressor 3 (motocondensing unit)
57. Request / partialization 3 of compressor 3 (motocondensing unit)
58. Request compressor #4
59. Request / partialization 1 of compressor 4 (motocondensing unit)
60. Request / partialization 2 of compressor 4 (motocondensing unit)
61. Request / partialization 3 of compressor 4 (motocondensing unit)
62. Request compressor #5 (motocondensing unit)
63. Request compressor #6(motocondensing unit)

8.4 DIGITAL OUTPUT (RELAY) CONFIGURATION RL1- RL14

Parameter involved:

CF54= Configuration RL1... **CF67=** Configuration RL14

0. Not enabled
1. Alarm
2. Evaporator water pump / Supply fan
3. Support water pump of the evaporator
4. Anti-freeze heater / integration heating / boiler circuit #1
5. Anti-freeze heater / integration heating / boiler circuit #2
6. Water pump of the condenser recovery circuit
7. Support water pump of the condenser recovery circuit
8. 4-way valve for chiller / heat pump inversion of the circuit #1
9. 4-way valve for chiller / heat pump inversion of the circuit #2
10. 1° condenser fan step ON/OFF control of the circuit #1
11. 2° condenser fan step ON/OFF control of the circuit #1
12. 3° condenser fan step ON/OFF control of the circuit #1
13. 4° condenser fan step ON/OFF control of the circuit #1
14. 1° condenser fan step ON/OFF control of the circuit #2
15. 2° condenser fan step ON/OFF control of the circuit #2
16. 3° condenser fan step ON/OFF control of the circuit #2
17. 4° condenser fan step ON/OFF control of the circuit #2
18. Solenoid valve of the pump-down circuit #1
19. Solenoid valve of the pump-down circuit #2
20. Recovery valve circuit #1
21. Recovery valve circuit #2
22. Free cooling ON/OFF valve
23. Auxiliary output circuit #1
24. Auxiliary output circuit #2
25. Pulse valve for screw compressor #1
26. Solenoid valve Intermittent for screw compressor #2
27. Solenoid valve of the liquid injection for compressor #1
28. Solenoid valve of the liquid injection for compressor #2
29. Direct start-up : compressor #1 relay
PW start: relay PW #1 of the compressor #1
Star-delta start: relay line #1 of the compressor #1
30. PW start: relay PW #2 of the compressor #1

- Star-delta start: relay linea #2 compressor #1
31. Star centre of the Star-delta start of the compressor 1#
 32. Capacity step valve #1 compressor #1
 33. Capacity step valve #2 compressor #1
 34. Capacity step valve #3 compressor #1
 35. By-pass gas valve compressor #1start
 36. Direct start: compressor #2 start
PW start: relay #1 of the compressor 2#
Star-delta start: relay line #1 of the compressor #2
 37. PW start: relay PW #2 of the compressor #2
Star-delta start: relay line #2 of the compressor #2
 38. Star centre of the Star-delta start of the compressor #2
 39. Capacity step valve #1 compressor #2
 40. Capacity step valve #2 compressor #2
 41. Capacity step valve #3 compressor #2
 42. By-pass gas valve compressor #2 start
 43. Direct start: compressor #3 relay
PW start: relay PW #1 of the compressor #3
Star-delta start: relay line #1 of the compressor #3
 44. PW start: relay PW #2 of the compressor #3
Star-delta start: relay line #1 of the compressor #3
 45. Star centre of the Star-delta start of the compressor #3
 46. Capacity step valve #1 compressor #3
 47. Capacity step valve #2 compressor #3
 48. Capacity step valve #3 compressor #3
 49. By-pass gas valve compressor #3 start
 50. Direct start: compressor #4 relay
PW start: PW#1 of the compressor #4
Star-delta start: relay line #1 of the compressor #4
 51. PW start: relay PW #2 of the compressor #4
Star-delta start: relay line#1 of the compressor #4
 52. Star centre of the Star-delta start of the compressor #4
 53. Capacity step valve #1 of the compressor #4
 54. Capacity step valve #2 of the compressor #4
 55. Capacity step valve #3 of the compressor #4
 56. By-pass gas valve compressor #4 start
 57. Compressor #5 relay
 58. Compressor #6 relay

8.5 CONDENSER PROPORTIONAL CONTROL CONFIGURATION (2 OUTPUTS)

Proportional outputs used to configure a proportional output signal to condenser fan control

Parameters involved:

CF68 = Condenser control configuration for circuit 1

CF69 = Condenser control configuration for circuit 2

0= 0 ÷ 10Vdc (for external mono or three-phase fan control board)

1= 4÷20mA (for external mono or three-phase fan control board)

2= PWM (only for external mono-phase fan control board with cut phase control)

8.6 PROPORTIONAL OUTPUT CONFIGURATION 0 ÷ 10 VDC (4 OUTPUTS)

Parameters involved:

CF70 = Proportional output 1 configuration

CF71 = Proportional output 2 configuration

CF72 = Proportional output 3 configuration

CF73 = Proportional output 4 configuration

- 0 Not enabled
- 1 Free cooling dumper / mixing valve
- 2 3-way valve for hot water
- 3 Dumper for air change
- 4 Auxiliary output

After the read-out number 4 the display goes from the label "o 1" to "c22" (see input/output polarity), that allow to configure the output as digital output to control an external relay.

8.7 OTHER OUTPUTS

Hot key connection

TTL connection

Remote keyboard connection

9 TABLE OF THE PARAMETERS

MENU SELECTION

Label	Description
ALL	Shows all the parameters
ST	Shows only the Thermoregulation parameters
CF	Shows only the Configuration parameters
SD	Shows only the Dynamic Setpoint parameters
ES	Shows only the Energy Saving, RTC parameters
CO	Shows only the compressor parameters
US	Shows only the Auxiliary Output parameters
FA	Shows only the Fan Control parameters
Ar	Shows only the Antifreeze Control parameters
DF	Shows only the Defrost parameters
AL	Shows only the Alarm parameters

Thermoregulation

Parameter	Description	min	max	u.m.	Resolution
ST 1	Chiller Setpoint Allow to modify the setpoint of the unit in chiller mode	ST02	ST03	°C/°F	dec/int
ST 2	Chiller minimum Setpoint Minimum setpoint limit for ST 1	-30.0 -22	ST01	°C °F	dec/int
ST 3	Chiller maximum Setpoint Maximum setpoint limit for ST 1	ST01	70.0 158	°C °F	dec/int
ST 4	Heat pump setpoint Allow to modify the setpoint of the unit in heat pump mode	ST05	ST06	°C/°F	dec/int
ST 5	Heat pump minimum Setpoint Minimum setpoint limit for ST 4	-30.0 -22	ST04	°C °F	Dec int
ST 6	Heat pump maximum Setpoint Maximum setpoint limit for ST 4	ST04	70.0 158	°C °F	Dec int
ST 7	Regulation band in chiller mode	0.0 0	25.0 45	°C °F	Dec int
ST 8	Regulation band in chiller heat pump	0.0 0	25.0 45	°C °F	Dec int
ST 9	Thermoregulation probe selection in chiller 0= Temperature probe NTC for evaporator inlet 1= Temperature probe NTC for evaporator outlet 1 2= Temperature probe NTC for evaporator outlet 2 3= Temperature probe NTC for common evaporator outlet 4= Temperature NTC probe from remote panel 1 5= Temperature NTC probe from remote panel 2	0	5		
ST 10	Thermoregulation probe selection in heat pump 0= Temperature probe NTC for evaporator inlet 1= Temperature probe NTC for evaporator outlet 1 2= Temperature probe NTC for evaporator outlet 2 3= Temperature probe NTC for common evaporator outlet 4= Temperature NTC probe from remote panel 1 5= Temperature NTC probe from remote panel 2 6= Temperature probe for water common inlet of the condenser 7= Temperature probe for water inlet of the circuit # 1 condenser 8= Temperature probe for water inlet of the circuit # 2 condenser 9= Temperature probe for water outlet of the circuit # 1 condenser 10= Temperature probe for water outlet of the circuit # 2 condenser 11= Temperature probe for water common outlet of the condenser ATTENTION To have the same thermoregulation for chiller and heat pump mode, set the parameters ST09 and ST10 with the same value	0	11		
ST 11	Type of thermoregulation 0= Proportional 1= Neutral zone 2= PI Proportional Integral	0	2		
Pr1	Password	0	999		
Pr2	Password	0	999		
Pr3	Password	0	999		

Display read-out

Parameter	Description	min	max	M. u.	Resolution
-----------	-------------	-----	-----	-------	------------

dP 1	Default read-out of the top display	0	14		
dP 2	Default read-out of the bottom display	0	17		
dP 3	Default display read-out configuration top / bottom 0= Configurable 1= Top display: Evaporator IN, Bottom display: Evaporator OUT 2= Top display: Condenser IN, Bottom display: Condenser OUT 3=Top display: temperature/Condensing pressure, Bottom Display: evaporating pressure	0	3		
Display read-out of the remote terminals					
dP4	Top display default read-out of the remote terminal_1 0= the read-out depends on the parameters dP01 – dP02 – dP03 1= the read-out shows the NTC probe of the remote panel.	0	1		
dP5	Top display default read-out of the remote terminal_2 0= the read-out depends on the parameters dP01 – dP02 – dP03 1= the read-out shows the NTC probe of the remote panel.	0	1		
Pr1	Password	0	999		
Pr2	Password	0	999		
Pr3	Password	0	999		
Configuration					
Parameter	Description	min	max	M. u.	Resolution
Unit Model					
CF 1	Type of unit 0= Air / air Chiller 1= Air / water Chiller 2= Water / water Chiller	0	2		
CF 2	Heat pump 0= no 1= Yes	0	1		
CF 3	Motocondensing unit (not available) 0= no 1= si	0	1		
Compressors					
CF 4	Compressors number for circuit #1 1= 1 2= 2 3= 3 4= 4	0	4		
CF 5	Compressors number for circuit #2 0= 0 1= 1 2= 2 3= 3	0	3		
CF 6	Number of compressor parzialization 0= none 1= 1 2= 2 3= 3	0	3		
Analog Inputs					
CF 7	Pressure or temperature analogue input functioning 0 = Temperature / pressure NTC – 4÷20 mA : The condensing temperature is controlled with NTC probe while for the evaporating pressures of the circuits 1 and 2 and the pressure probe configured as auxiliary output 1 and 2 are controlled with 4÷20mA transducers. 1 = Pressure control with 4÷20 mA: To control the evaporating and condensing pressures it is necessary a 4÷20mA transducer. 2 = Temperature / pressure NTC – 0÷5Vdc: The condensing temperature is controlled with NTC probe while for the evaporating pressures of the circuits 1 and 2 and the pressure probe configured as auxiliary output 1 and 2 are controlled with 0÷5Vdc transducers. 3 = Pressure control with 0÷5Vdc: To control the evaporating and condensing pressures it is necessary a ratiometric 0÷5Vdc transducer.	0	3		
CF 8	PB1 Configuration If configured as digital input	0 o 1	25 c63		
CF 9	PB2 Configuration If configured as digital input	0 o 1	25 c63		
CF 10	PB3 Configuration If configured as digital input	0 o 1	30 c63		
CF 11	PB4 Configuration If configured as digital input	0 o 1	30 c63		
CF 12	PB5 Configuration If configured as digital input	0 o 1	30 c63		

CF 13	PB6 Configuration If configured as digital input	0 o 1	30 c63		
CF 14	PB7 Configuration If configured as digital input	0 o 1	25 c63		
CF 15	PB8 Configuration If configured as digital input	0 o 1	25 c63		
CF 16	PB9 Configuration If configured as digital input	0 o 1	25 c63		
CF 17	PB10 Configuration If configured as digital input	0 o 1	25 c63		
Probe Offset					
CF 18	PB1 Offset	-12.0 -10	12.0 53	°C °F	Dec int
CF 19	PB2 Offset	-12.0 -10	12.0 53	°C °F	Dec int
CF 20	PB3 Offset	-12.0 -10 -5.0 -72	12.0 53 5.0 72	°C °F bar psi	Dec int dec int
CF 21	PB4 Offset	-12.0 -10 -5.0 -72	12.0 53 5.0 72	°C °F bar psi	Dec int dec int
CF 22	PB5 Offset	-12.0 -10 -5.0 -72	12.0 53 5.0 72	°C °F bar psi	Dec int dec int
CF 23	PB6 Offset	-12.0 -10 -5.0 -72	12.0 53 5.0 72	°C °F bar psi	Dec int dec int
CF 24	PB7 Offset	-12.0 -10	12.0 53	°C °F	Dec int
CF 25	PB8 Offset	-12.0 -10	12.0 53	°C °F	Dec int
CF 26	PB9 Offset	-12.0 -10	12.0 53	°C °F	Dec int
CF 27	PB10 Offset	-12.0 -10	12.0 53	°C °F	Dec int
CF 28	Pressure value at 4mA or 0.5 Vdc of the PB3 transducer	0 0	50.0 725	Bar psi	Dec int
CF 29	Pressure value at 20mA or 5 Vdc of the PB3 transducer	0 0	50.0 725	Bar psi	Dec int
CF 30	Pressure value at 4mA or 0.5 Vdc of the PB4 transducer	0 0	50.0 725	Bar psi	Dec int
CF 31	Pressure value at 20mA or 5 Vdc of the PB4 transducer	0 0	50.0 725	Bar psi	Dec int
CF 32	Pressure value at 4mA or 0.5 Vdc of the PB5 transducer	0 0	50.0 725	Bar psi	Dec int
CF 33	Pressure value at 20mA or 5 Vdc of the PB5 transducer	0 0	50.0 725	Bar psi	Dec int
CF 34	Pressure value at 4mA or 0.5 Vdc of the PB6 transducer	0 0	50.0 725	Bar psi	Dec int
CF 35	Pressure value at 20mA or 5 Vdc of the PB6 transducer	0 0	50.0 725	Bar psi	Dec int
Digital Inputs					
CF 36	Configuration of ID1	0 -o1	c63		
CF 37	Configuration of ID2	0 -o1	c63		
CF 38	Configuration of ID3	0 -o1	c63		
CF 39	Configuration of ID4	0 -o1	c63		
CF 40	Configuration of ID5	0 -o1	c63		
CF 41	Configuration of ID6	0 -o1	c63		
CF 42	Configuration of ID7	0 -o1	c63		
CF 43	Configuration of ID8	0 -o1	c63		
CF 44	Configuration of ID9	0 -o1	c63		
CF 45	Configuration of ID10	0 -o1	c63		
CF 46	Configuration of ID11	0 -o1	c63		
CF 47	Configuration of ID12	0 -o1	c63		
CF 48	Configuration of ID13	0 -o1	c63		
CF 49	Configuration of ID14	0 -o1	c63		
CF 50	Configuration of ID15	0 -o1	c63		
CF 51	Configuration of ID16	0 -o1	c63		
CF 52	Configuration of ID17	0 -o1	c63		
CF 53	Configuration of ID18	0 -o1	c63		

Relay Outputs					
CF 54	Configuration of RL1	0 -01	c58		
CF 55	Configuration of RL2	0 -01	c58		
CF 56	Configuration of RL3	0 -01	c58		
CF 57	Configuration of RL4	0 -01	c58		
CF 58	Configuration of RL5	0 -01	c58		
CF 59	Configuration of RL6	0 -01	c58		
CF 60	Configuration of RL7	0 -01	c58		
CF 61	Configuration of RL8	0 -01	c58		
CF 62	Configuration of RL9	0 -01	c58		
CF 63	Configuration of RL10	0 -01	c58		
CF 64	Configuration of RL11	0 -01	c58		
CF 65	Configuration of RL12	0 -01	c58		
CF 66	Configuration of RL13	0 -01	c58		
CF 67	Configuration of RL14	0 -01	c58		
Condensing proportional outputs					
CF 68	Circuit 1 output signal: 0= 0 – 10Vdc 1= 4 ÷ 20mA 2= PWM for mono phase fan control board	0	2		
CF 69	Circuit 2 output signal: 0= 0 – 10V 1= 4 ÷ 20Ma 2= PWM for mono phase fan control board	0	2		
Uscite modulanti					
CF 70	Proportional output 1 0= Not enabled 1= Free cooling Dumper / Mixing valve 2= 3-way valve for hot water 3= Dumper for air change 4= auxiliary output Relay driver ON / OFF	0 o 1	4 c28		
CF 71	Proportional output 2 0= Not enabled 1= Free cooling Dumper / Mixing valve 2= 3-way valve for hot water 3= Dumper for air change 4= auxiliary output Relay driver ON / OFF	0 o 1	4 c28		
CF 72	Proportional output 3 0= Not enabled 1= Free cooling Dumper / Mixing valve 2= 3-way valve for hot water 3= Dumper for air change 4= auxiliary output Relay driver ON / OFF	0 o 1	4 c28		
CF 73	Proportional output 4 0= Not enabled 1= Free cooling Dumper / Mixing valve 2= 3-way valve for hot water 3= Dumper for air change 4= auxiliary output Relay driver ON / OFF	0 o 1	4 c28		
Terminale remoto					
CF 74	Remote Panel 1 configuration 0= Not enabled 1= with NTC ambient temperature sensor 2= without NTC ambient temperature sensor	0	2		
CF 75	Remote Panel 2 configuration 0= Not enabled 1= with NTC ambient temperature sensor 2= without NTC ambient temperature sensor	0	2		
CF 76	Offset of the NTC probe of the remote terminal # 1	-12.0 -10	12.0 53	°C °F	Dec int
CF 77	Offset of the NTC probe of the remote terminal # 2	-12.0 -10	12.0 53	°C °F	Dec int
Icon function					
CF 78	Icon function 0= ❄️ chiller / 🔥 heat pump 1= 🔥 chiller / ❄️ heat pump	0	1		
Chiller / heat pump selection mode					

CF 79	0= from keyboard 1= from digital input 2= from analogue input	0	2		
Automatic Change over					
CF 80	Change over setpoint for chiller/ heat pump inversion if Par. CF80=2	-30.0 -22	70.0 158	°C °F	Dec int
CF 81	Change over temperature differential if Par. CF80=2	0 0	25.0 45	°C °F	Dec int
U. m. Unit of measurement					
CF 82	°C or °F selection 0= °C / °BAR 1= °F / °psi	0	1		
Voltage frequency					
CF 83	Power supply frequency 0= 50 Hz 1= 60 Hz 2= cc voltage (ATTENTION with Par. CF81 = 2 the proportional outputs for fan control are not enabled and the frequency alarm is inhibited)	0	2		
Serial Address					
CF 84	Serial address	1	247		
CF 85	Firmware Release				
CF 86	Eeprom parameter map				
Pr1	Password	0	999		
Pr2	Password	0	999		
Pr3	Password	0	999		
Dynamic Setpoint					
Parameters	Description	min	max	M. u.	Resolution
Sd 1	Maximum dynamic Offset in chiller mode	-30.0 -54	30.0 54	°C °F	Dec int
Sd 2	Maximum dynamic Offset in heat pump mode	-30.0 -54	30.0 54	°C °F	Dec int
Sd 3	External air setpoint in chiller mode	-30.0 -22	70.0 158	°C °F	Dec int
Sd 4	External air setpoint in heat pump mode	-30 -22	70.0 158	°C °F	Dec int
Sd 5	External air differential in chiller mode	-30.0 -54	30.0 54	°C °F	Dec int
Sd 6	External air differential in heat pump mode	-30.0 -54	30.0 54	°C °F	Dec int
Pr1	Password	0	999		
Pr2	Password	0	999		
Pr3	Password	0	999		
Energy saving					
Parameters	Description	min	max	udm	Risoluzione
ES 1	Start of the Time band 1 (0+24)	0	24.00	Hr	10 Min
ES 2	End of the Time Band 1 (0+24)	0	24.00	Hr	10 Min
ES 3	Start of the Time band 2 (0+24)	0	24.00	Hr	10 Min
ES 4	End of the Time Band 2 (0+24)	0	24.00	Hr	10 Min
ES 5	Start of the Time band 3 (0+24)	0	24.00	Hr	10 Min
ES 6	End of the Time Band 3 (0+24)	0	24.00	Hr	10 Min
ES 7	Monday: energy saving activated Automatic unit on-off	0 - 0	7 - 7		
ES 8	Tuesday energy saving activated Automatic unit on-off	0 - 0	7 - 7		
ES 9	Wednesday energy saving activated Automatic unit on-off	0 - 0	7 - 7		
ES 10	Thursday energy saving activated Automatic unit on-off	0 - 0	7 - 7		
ES 11	Friday energy saving activated Automatic unit on-off	0 - 0	7 - 7		
ES 12	Saturday energy saving activated Automatic unit on-off	0 - 0	7 - 7		
ES 13	Sunday energy saving activated Automatic unit on-off	0 - 0	7 - 7		
ES 14	Energy Saving setpoint offset in chiller mode	-30.0 -54	30.0 54	°C °F	Dec int
ES 15	Energy Saving differential in chiller mode	0.0 0	25.0 45	°C °F	Dec int
ES 16	Energy Saving setpoint offset in heat pump mode	-30.0 -54	30.0 54	°C °F	Dec int

ES 17	Energy Saving differential in heat pump mode	0.0 0	25.0 45	°C °F	Dec int
Pr1	Password	0	999		
Pr2	Password	0	999		
Pr3	Password	0	999		
Compressors					
Parameters	Description	min	max	udm	Risoluzione
CO 1	Minimum compressor ON time after the start-up.	0	250	10 sec	10 sec
CO 2	Minimum compressor OFF time after the switching off.	0	250	10 sec	10 sec
CO 3	ON delay time between two compressors or compressor and valve. During this time the led of the next resource is blinking.	1	250	Sec	
CO 4	OFF delay time between two compressors or compressor and valve. During this time the led of the next resource is blinking.	0	250	Sec	
CO 5	Output time delay after the main power supply start-up to the unit. All the loads are delayed in case of frequently power failures.	0	250	10 Sec	10 sec
Partialization (Capacity Control)					
CO 6	Functioning (see Capacity Control) 0= With on/off steps 1= Continuous with steps and direct action 2= Continuous with steps and reverse action 3= Continuous with steps and direct total action	0	3		
CO 7	Start-up with minimum compressor power / automatic start-unloading valve 0 = Only at the compressor start-up (Minimum power automatic start-unloading valve off) 1= At the compressor start-up and during the termoregulation (Minimum power / automatic start-unloading valve off) 2 = Only at the screw compressor start-up (Minimum power automatic start-unloading valve off) 3= At the compressor start-up and during the termoregulation (Minimum power / Unloading valve ON with compressor off)	0	3		
CO 8	Relay ON time of the Solenoid valve Intermittent for screw compressor, with 0 the function is not enabled.	0	250	Sec	
CO 9	Relay OFF time of the Solenoid valve Intermittent for screw compressor	0	250	Sec	
Compressor start-up					
CO 10	Kind of compressor start-up 0= Direct (vedi avviamento compressors) 1= Part - winding 2= Star-delta	0	2		
CO 11	If CO10= 1 part - winding start-up time. To change the time delay between the two contactors of the two compressor circuits. Se CO10= 2 Star-delta start-up time. To change the time delay between the contactor of the line 1 and the contactor of the centre of the star. (see part - winding /start-triangle functioning)	0	100	Dec. di Sec	0.1 sec
CO 12	If CO10= 2 Time of Star-delta start. Time delay to turn off the centre star contactor and to turn on the line 2 contactor (see Star-delta functioning)	0	50	Dec. di Sec	0.1 sec
CO 13	By-pass gas valve start-up time / automatic start-unloading valve (capacity step control)	0	250	sec	
Rotating – Balancing – Compressors Thermoregulation					
CO 14	Compressor rotation (See compressor rotation) 0 = Sequential 1 = Compressors rotation based on time running hours 2 = Compressors rotation based on number of starts-up	0	2		
CO 15	Circuit balancing (See Circuit balancing) 0= Circuit saturation 1= Circuit balancing	0	1		
Evaporator water pump					
CO 16	Operative mode of the evaporator pump / supply fan (See Evaporator pump function) 0= Not enabled (evaporator pump or supply fan). 1= Continuous. When the unit is running in Chiller or HP the pump or the supply fan is running. 2= With compressor. When a compressor is running also the pump or the supply fan is running.	0	2		
CO 17	ON compressor delay after water pump / supply fan start-up (See water pump functioning).	1	250	Min	
CO 18	OFF delay evaporator water pump / supply fan after compressor switching OFF. This delay is also active when the unit is turned in stand-by (See evaporator water pump function).	0	250	Min	
CO 19	Number of time running hours for pump rotation (See water pump group function)	0	999	10Hr	10Hr

CO 20	Time to make run the pumps together before rotating from one to the other (See water pump group function)	0	250	Sec	
Condenser water pump					
CO 21	Operative mode for condenser water pump (See condenser water pump function) 0= Not enabled. 1= Continuous. When the unit is running in Chiller or HP the is running. 2= With compressor. When a compressor is running also the pump is running.	0	2		
CO 22	Free				
CO 23	OFF delay condenser water pump after compressor switching OFF. This delay is also active when the unit is turned in stand-by (See evaporator water pump function).	0	250	Min	
CO 24	Number of time running hours for pump rotation (See water pump group function).	0	999	10Hr	10Hr
CO 25	Time to make run the pumps together before rotating from one to the other (See water pump group function).	0	250	Sec	
Load maintenance					
CO 26	Compressor 1 hour counter set (See maintenance request)	0	999	10 Hr	10 Hr
CO 27	Compressor 2 hour counter set (See maintenance request)	0	999	10 Hr	10 Hr
CO 28	Compressor 3 hour counter set (See maintenance request)	0	999	10 Hr	10 Hr
CO 29	Compressor 4 hour counter set (See maintenance request)	0	999	10 Hr	10 Hr
CO 30	Compressor 5 hour counter set (See maintenance request)	0	999	10 Hr	10 Hr
CO 31	Compressor 6 hour counter set (See maintenance request)	0	999	10 Hr	10 Hr
CO 32	"Evaporator pump / Supply fan" hour counter set (See maintenance request)	0	999	10 Hr	10 Hr
CO 33	2 nd Evaporator pump hour counter set (See maintenance request)	0	999	10 Hr	10 Hr
CO 34	Condenser pump hour counter set (See maintenance request)	0	999	10 Hr	10 Hr
CO 35	2 nd Condenser pump hour counter set (See maintenance request)	0	999	10 Hr	10 Hr
Pump down					
CO 36	Pump down operating mode (See pump down ON/OFF function) 0= Not enabled 1= Unit off with pump-down, unit on without pump-down 2= Unit off with pump-down, unit on with pump-down 3= Chiller mode off with pump-down, chiller mode on without pump-down 4= Chiller mode off with pump-down, chiller mode on with pump-down	0	4		
CO 37	Pump-down pressure setpoint (See pump down ON/OFF function)	0 0	50.0 725	Bar psi	Dec int
CO 38	Pump-down pressure differential (See pump down ON/OFF function)	0 0	14.0 203	Bar psi	Dec int
CO 39	Maximum pump-down time duration at start-up and stop (See pump down ON/OFF function)	0	250	Sec	
Evaporator Unloading					
CO 40	Unloading compressor setpoint in chiller. From high temperature of the evaporator water inlet (See unloading function).	-30 0	70.0 725	°C °F	Dec int
CO 41	Unloading Differential. From high temperature of the evaporator water inlet (See unloading function).	0.0 0	25.0 45	°C °F	Dec int
CO 42	Delay time to engage the Unloading function from high temperature of the evaporator water inlet (See unloading function).	0	250	Sec	10sec
CO 43	Maximum unloading duration time to keep activated the Unloading function from high temperature of the evaporator water inlet (See unloading function).	0	250	Min	
Condenser Unloading					
CO 44	Unloading compressor setpoint. From temperature / pressure in chiller mode (See unloading function).	0 0	50.0 725	Bar psi	Dec int
CO 45	Unloading Differential. From temperature / pressure in chiller mode (See unloading function).	0.0 0	14.0 203	Bar Psi	Dec int
CO 46	Unloading compressor setpoint. From temperature / pressure in HP mode (See unloading function).	0 0	50.0 725	Bar psi	Dec int
CO 47	Unloading Differential. From temperature / pressure in HP mode (See unloading function).	0.0 0	14.0 203	Bar Psi	Dec int
CO 48	Maximum unloading duration time from temperature/pressure control.	0	250	Min	
CO 49	Number of steps for circuit with active unloading 1= 1 st step 2= 2 nd step 3= 3 rd step	1	3		
CO 50	Minimum ON time of the capacity step after the unloading function start (only for capacity compressor)	0	250	Sec	
Compressor liquid injection					
CO 51	Setpoint of the solenoid valve (on) of the liquid injection	0 0	150 302	°C °F	Dec / int int
CO 52	Setpoint of the solenoid valve (off) of the liquid injection	0.0 0	25.0 45	°C °F	Dec int
Pr1	Password	0	999		
Pr2	Password	0	999		
Pr3	Password	0	999		

Auxiliary relay menu function					
Parameters	Description	min	max	M. U.	Resolution
Auxiliary relay of the circuit 1					
US 1	Auxiliary relay 1 operating mode (See graph and auxiliary relay functions) 0= Not enabled 1= Always available with direct action 2= Available only when the unit is on with direct action 3= Always available with reverse action 4= Available only when the unit is on with reverse action	0	4		
US 2	Analog input configuration for auxiliary relay 1 control. Allows to select which probe value Pb1..Pb10 controls the relay	1	10		
US 3	Auxiliary setpoint 1 (See graph and auxiliary relay functions)	-30.0 -22 0.0 0	70.0 158 50.0 725	°C °F Bar Psi	Dec int Dec int
US 4	Auxiliary differential 1 (See graph and auxiliary relay functions)	0.0 0 0.0 0	25.0 45 14.0 203	°C °F Bar Psi	Dec int Dec int
Auxiliary relay circuit 2					
US 5	Auxiliary relay 2 operating mode (See graph and auxiliary relay functions) 0= Not enabled 1= Always available with direct action 2= Available only when the unit is on with direct action 3= Always available with reverse action 4= Available only when the unit is on with reverse action	0	4		
US 6	Analog input configuration for auxiliary relay 2 control . Allows to select which probe value Pb1..Pb10 controls the relay	1	10		
US 7	Auxiliary setpoint 2 (See graph and auxiliary relay functions)	-30.0 -22 0.0 0	70.0 158 50.0 725	°C °F Bar Psi	Dec int Dec int
US 8	Auxiliary differential 1 (See graph and auxiliary relay functions)	0.0 0 0.0 0	25.0 45 14.0 203	°C °F Bar Psi	Dec int Dec int
Pr1	Password	0	999		
Pr2	Password	0	999		
Pr3	Password	0	999		
Condenser fan					
Parameters	Description	min	max	M. U.	Resolution
FA 1	Fan configuration output 0 = Not enabled 1 = Always on 2 = ON/OFF regulation with steps 3 = ON/OFF Continuous regulation 4 = Proportional speed control	0	4		
FA 2	Fan operating mode 0= Dependent from the compressor 1= Independent from the compressor	0	1		
FA 3	If the condenser fan control is the triac output, when the regulation starts the trigger output will drive the condenser fan at the maximum voltage for the time FA 3 then, then the regulation will follow the temperature/pressure of the probe.	0	250	Sec	
FA 4	Phase shifting of the fan motor	0	8	Micro Sec	250µs
FA 5	Number of condensing circuits 0= one condenser circuit 1= tow condenser circuits	0	1		
FA 6	Pre-ventilation time before turning on the compressor in chiller mode. To turn on the fan at the maximum speed before the compressor and reduce the successive condensing temperature/pressure increasing. (only if FA01=4)	0	250	Sec	
Fan in Chiller mode					
FA 7	Minimum speed for condenser fan in Chiller mode. To set the minimum fan speed percentage value (30..100%), it is related to the fan power supply.	30	100	%	
FA 8	Maximum speed for condenser fan in Chiller mode. To set the maximim fan speed percentage value (30..100%), it is related to the fan power supply.	30	100	%	
FA 9	Proportional speed control FA01 = 4 Temperature or pressure limit to enable the minimum speed FA 7 ON/OFF regulation FA01 = 2/3 SETpoint step n° 1	-30.0 -22 0.0 0	70.0 158 50.0 725	°C °F Bar Psi	Dec int Dec int

FA 10	Proportional speed control FA01 = 4 Temperature or pressure limit to enable the maximum speed FA 8 ON/OFF regulation FA01 = 2/3 SETpoint step n° 2	-30.0 -22 0.0 0	70.0 158 50.0 725	°C °F Bar Psi	Dec int Dec int
FA 11	Proportional speed control FA01 = 4 Proportional band for condenser fan control in chiller To set the temperature/pressure differential between the minimum and the maximum of the fan speed regulation. ON/OFF regulation FA01 = 2/3 Differential step circuit n° 1	0.0 0 0.0 0	25.0 45 14.0 203	°C °F Bar Psi	Dec int Dec int
FA 12	Proportional speed control FA01 = 4 CUT-OFF differential in chiller. To set a temperature/pressure differential to stop the fan. ON/OFF regulation FA01 = 2/3 Differential step circuit n° 2	0.0 0 0.0 0	25.0 45 14.0 203	°C °F Bar Psi	Dec int Dec int
FA 13	Over ride CUT- OFF in chiller. To set a temperature/pressure differential to keep the minimum fan speed.	0.0 0 0.0 0	25.0 45 14.0 203	°C °F Bar Psi	Dec int Dec int
FA 14	CUT-OFF time delay. To set a time delay before activating the CUT-OFF function after the fan start-up. If after the compressor start-up the proportional regulator requires to turn off the fan (cut-off) and FA14≠0, the fan is on at the minimum speed for the time set in this parameter. If FA14=0 the function is disabled.	0	250	Sec	
FA 15	Night speed in chiller. To set the maximum fan speed percentage value (30..100%), it is related to the fan power supply.	30	100	%	
Fan in Heat pump mode					
FA 16	Minimum speed for condenser fan in Heat Pump mode. To set the minimum fan speed percentage value (30..100%), it is related to the fan power supply.	30	100	%	
FA 17	Maximum speed for condenser fan in Heat Pump mode. To set the maximum fan speed percentage value (30..100%), it is related to the fan power supply.	30	100	%	
FA 18	Proportional speed control FA01 = 4 Temperature or pressure limit to enable the minimum speed FA16 ON/OFF regulation FA01 = 2/3 SETpoint step n° 1	-30.0 -22 0.0 0	70.0 158 50.0 725	°C °F Bar Psi	Dec int Dec int
FA 19	Proportional speed control FA01 = 4 Temperature or pressure limit to enable the maximum speed FA17 ON/OFF regulation FA01 = 2/3 SETpoint step n° 2	-30.0 -22 0.0 0	70.0 158 50.0 725	°C °F Bar Psi	Dec int Dec int
FA 20	Proportional speed control FA01 = 4 Proportional band for condenser fan control in heat pump To set the temperature/pressure differential between the minimum and the maximum of the fan speed regulation. ON/OFF regulation FA01 = 2/3 Differential step circuit n° 1	0.0 0 0.0 0	25.0 45 14.0 203	°C °F Bar Psi	Dec int Dec int
FA 21	Proportional speed control FA01 = 4 CUT-OFF differential in heat pump. To set a temperature/pressure differential to stop the fan. ON/OFF regulation FA01 = 2/3 Differential step circuit n° 2	0.0 0 0.0 0	25.0 45 14.0 203	°C °F Bar Psi	Dec int Dec int
FA 22	Over ride CUT- OFF in Heat pump. To set a temperature/pressure differential to keep the minimum fan speed.	0.0 0 0.0 0	25.0 45 14.0 203	°C °F Bar Psi	Dec int Dec int
FA 23	Night speed in Heat pump. To set the maximum fan speed percentage value (30..100%), it is related to the fan power supply.	30	100	%	
Hot start					
FA 24	Hot start setpoint	-30.0 -22	70.0 158	°C °F	Dec int
FA 25	Hot start differential	0.0 0	25.0 45	°C °F	Dec int
3 / 4 step condenser Fan in Chiller mode					
FA 26	ON/OFF regulation FA01 = 2/3 SETpoint step n° 3	-30.0 -22 0.0 0	70.0 158 50.0 725	°C °F Bar Psi	Dec int Dec int
FA 27	ON/OFF regulation FA01 = 2/3 SETpoint step n° 4	-30.0 -22 0.0 0	70.0 158 50.0 725	°C °F Bar Psi	Dec int Dec int
3 / 4 step condenser Fan in heat pump					

FA 28	ON/OFF regulation FA01 = 2/3 SETpoint step n° 3	-30.0 -22 0.0 0	70.0 158 50.0 725	°C °F Bar Psi	Dec int Dec int
FA 29	ON/OFF regulation FA01 = 2/3 SETpoint step n° 4	-30.0 -22 0.0 0	70.0 158 50.0 725	°C °F Bar Psi	Dec int Dec int
Pr1	Password	0	999		
Pr2	Password	0	999		
Pr3	Password	0	999		
Antifreeze heaters – Integration heating - boiler					
Parameter	Description	min	max	m. u.	Risoluzione
Ar 1	Anti-freeze heaters/integration heating setpoint for air/air unit in Chiller mode. To set a temperature value, below this value the anti-freeze relay is activated.	-30.0 -22	70.0 158	°C °F	Dec int
Ar 2	Regulation band for antifreeze in Chiller mode.	0.1 0	25.0 45	°C °F	Dec int
Ar 3	Set Anti-freeze heaters/integration heating setpoint for air/air unit in HP mode. To set a temperature value, below this value the anti-freeze relay is activated.	-30.0 -22	70.0 158	°C °F	Dec int
Ar 4	Regulation band for antifreeze in HP mode.	-30.0 -22	70.0 158	°C °F	Dec int
Ar 5	Antifreeze heaters / integration heating in defrost 0= ON only with thermoregulation control 1= ON with thermoregulation and during the defrosting cycle	0	1		
Ar 6	Antifreeze alarm probe / heaters / appoggio in Chiller mode. 0= Not enabled 1= Evaporator inlet 2= Evaporator outlet 1 and 2 3= Evaporator outlet 1 and 2 and common outlet	0	3		
Ar 7	Antifreeze alarm probe / heaters / support heaters in HP mode. 0= Not enabled 1= Evaporator inlet. 2= Evaporator outlet 1 and 2. 3= Evaporator outlet 1 and 2 and common outlet.	0	3		
Ar 8	Thermoregulation probe for anti-freeze alarm / condenser heaters. 0= not enabled. 1= Condenser common water inlet probe. 2= Condenser common water inlet and condenser inlet 1 / 2 probe. 3= Condenser water outlet 1 / 2 probe. 4= Condenser water outlet 1 / 2 and common outlet.	0	4		
Ar 9	Anti-freeze heaters or condenser/evaporator water pump control with unit in remote OFF or stand-by mode: 0= Control not enable 1=Controlled by anti-freeze thermoregulation.	0	1		
Ar 10	Anti-freeze heaters control for condenser/evaporator faulty probe: 0= Anti-freeze heaters OFF 1= Anti-freeze heaters ON	0	1		
Boiler function					
Ar 11	Boiler function 0=Not enabled 1=Enabled for integration heating 2= Enabled for heating	0	2		
Ar 12	External air temperaure setpoint for boiler heaters (on)	-30.0 -22	70.0 158	°C °F	Dec int
Ar 13	Temperature differential for boiler heaters (off)	0 0	25.0 45	°C °F	Dec int
Ar 14	Time delay before turning the boiler on	0	250		Min
Boiler function in Chiller mode					
Ar 15	Setpoint for boiler heaters (on) in chiller	-30.0 -22	70.0 158	°C °F	Dec int
Ar 16	Proportional band for boiler heaters in chiller	-30.0 -22	70.0 158	°C °F	Dec int
Boiler function in heat pump					
Ar 17	Setpoint for boiler heaters (on) in HP	-30.0 -22	70.0 158	°C °F	Dec int
Ar 18	Proportional band for boiler heaters in HP	0.1 0	25.0 45	°C °F	Dec int
Ar 19	External air setpoint to stop the compressor as integration function	-30.0 -22	70.0 158	°C °F	Dec int
Ar 20	External air differential to stop the compressor as integration function	0.1 0	25.0 45	°C °F	Dec int
Pr1	Password	0	999		
Pr2	Password	0	999		

Pr3	Password	0	999		
Defrost					
Parameter	Description	min	max	udm	Risoluzione
dF 1	Defrost configuration: 0= Not enabled 1= Temperature / pressure 2= start depends on par. dF24 stop for time duration 3= start depends on par. dF24 stop for external contact	0	3		
dF 2	Temperature or pressure of the defrost start-up	-30.0 -22 0.0 0	70.0 158 50.0 725	°C °F bar psi	Dec int Dec Int
dF 3	Temperature or pressure of the defrost stop	-30.0 -22 0.0 0	70.0 158 50.0 725	°C °F bar psi	Dec int Dec Int
dF 4	Minimum defrost duration.	0	250	Sec	
dF 5	Maximum defrost duration.	1	250	Min	
dF 6	Time delay between the defrost of two circuits	0	250	Min	
dF 7	OFF compressor delay before the defrost	0	250	Sec	
dF 8	OFF compressor delay after the defrost	0	250	Sec	
dF 9	Defrost interval time of the same circuit	1	99	Min	
dF 10	Temperature setpoint for combined defrost of the 1 st circuit after parameter DF10 counting.	-30.0 -22	70.0 158	°C °F	Dec int
dF 11	Temperature setpoint for combined defrost end of the 1 st circuit.	-30.0 -22	70.0 158	°C °F	Dec int
dF 12	Temperature setpoint for combined defrost of the 2 nd circuit after parameter DF10 counting.	-30.0 -22	70.0 158	°C °F	Dec int
dF 13	Temperature setpoint for combined defrost end of the 2 nd circuit.	-30.0 -22	70.0 158	°C °F	Dec int
dF 14	Activation of all the steps of the 1 st circuit during the defrost. 0= Not enabled 1= Enabled	0	1		
dF 15	Activation of all the steps of the 2 nd circuit during the defrost. 0= Not enabled 1= Enabled	0	1		
dF 16	Time delay between two compressor ON in defrost mode	0	250	Sec	
dF 17	Fan control during defrost / dripping time 0= Not enabled 1= Only in defrost 2= For both functions defrost / dripping time	0	2		
dF 18	Pressure / temperature setpoint to force the ventilation ON during the defrost.	-30.0 -22 0.0 0	70.0 158 50.0 725	°C °F bar psi	Dec int Dec Int
Forced defrost					
dF 19	Minimum time delay before a forced defrost	0	250	sec	
dF 20	Pressure / temperature setpoint for a forced defrost	-30.0 -22 0.0 0	70.0 158 50.0 725	°C °F bar psi	Dec int Dec int
dF 21	Forced defrost differential	0.1 0 0.0 0	25.0 45 14.0 203	°C °F Bar Psi	Dec int Dec int
Defrost operative mode					
dF 22	Defrost start-up with 2 circuits 0= Independent 1= If both have reached the necessary requirements 2= If one has reached the necessary requirements	0	2		
dF 23	End defrost for two circuits and common ventilation. 0= Independent 1= If both have reached the necessary end defrost requirements 2= If one has reached the necessary end defrost requirements	0	2		
Start / stop defrost from analog input					
Parameters	description	min	max	udm	resolution
dF 24	Start / stop defrost probe 0= start and stop with condenser temperatur / pressure probe 1= start with evaporator pressure probe / stop with condenser temperatur / pressure probe 2= start with condenser temperatur / pressure probe / stop with evaporator pressure probe 3= start and stop with evaporator pressure probe	0	3		

Pr1	Password	0	999		
Pr2	Password	0	999		
Pr3	Password	0	999		
Recovery					
Parameters	description	min	max	udm	resolution
rC 1	Recovery modes 0 = not enabled 1 = 2 independent circuit 2 = both the circuit in parallel	0	2		
rC 2	Delay time delay with step forced off	0	250	Sec	
rC 3	Delay time delay with step forced off after the recovery valve activation	0	250	Sec	
rC 4	Recovery minimum time	0	250	Min	
rC 5	Minimum interval time between the end and the beginning of the next recovery	0	250	Min	
rC 6	Temperature setpoint to disable the recovery	-30.0 -22 0.0 0	70.0 158 50.0 725	°C °F Bar Psi	Dec int Dec int
rC 7	Temperature differential to restore the recovery	0.1 0 0.0 0	25.0 45 14.0 203	°C °F Bar Psi	Dec int Dec int
rC 8	Maximum time with recovery disabled (if temperature/pressure within rC6-rC7)	0	250	Min	
Pr1	Password	0	999		
Pr2	Password	0	999		
Pr3	Password	0	999		
Alarms					
Parameters	Description	min	max	m. u.	Resolution
Low alarm					
AL 1	Low pressure alarm delay from analog and digital input	0	250	Sec	
AL 2	Low pressure alarm delay from digital input after compressor stop if the low pressure switch is used for the pump down.	10	250	Sec	
AL 3	Low pressure alarm setpoint from analogue input	-30.0 -22 0.0 0	70.0 158 50.0 725	°C °F bar psi	Dec int Dec int
AL 4	Low pressure alarm differential from analogue input	0.1 0 0.0 0	25.0 45 14.0 203	°C °F bar psi	Dec int Dec int
AL 5	Maximum number of low pressure events from digital/analogue inputs: Manual reset if AL05 = 0 Automatic reset if AL05 =16 From automatic to manual reset if AL05= 1..15	0	16		
AL 6	Low temperature/pressure alarm during defrost 0= Not enabled 1= Enabled	0	1		
AL 7	Low temperature/pressure alarm delay during defrost	0	250	Sec	
AL 8	Low temperature/pressure alarm with unit in OFF or stand – by: 0 = Not enabled 1= Alarm enabled	0	1		
High Alarm					
AL 9	High temperature/pressure alarm from analogue input	-30.0 -22 0.0 0	70.0 158 50.0 725	°C °F bar psi	Dec int Dec int
AL 10	High temperature/pressure alarm differential from analogue input	0.1 0 0.0 0	25.0 45 14.0 203	°C °F bar psi	Dec int Dec int
Oil Alarm					
AL 11	Low oil pressure / level delay from digital input	0	250	Sec	
AL 12	Minimum time for low oil pressure / level from digital input activation in normal working condition.	0	250	Sec	
AL 13	Maximum number of low oil pressure/level events: Always manual reset if AL13= 0 Always automatic reset if AL13 =16 From automatic to manual reset if AL13 = 1..15	0	16		
Flow alarm					

AL 14	Configuration 0= Not enabled 1= Only for chiller 2= Only for heat pump 3= For both chiller and heat pump	0	3		
AL 15	"Flow switch / supply fan overload" alarm delay after pump/fun activation.	0	250	Sec	
AL 16	Maximum number of "flow switch/supply fan" alarm events Always manual reset if AL16 = 0 Always automatic reset if AL16 =16 From automatic to manual reset if AL16 =1..15	0/1	16		
AL 17	Minimum "Flow switch / supply fan overload" active time duration.	0	250	Sec	
AL 18	Minimum "Flow switch / supply fan overload" not active time duration.	0	250	Sec	
Compressor overload alarm					
AL 19	Compressor overload alarm delay after compressor start-up	0	250	Sec	
AL 20	Maximum number of compressor overload alarm events Always manual reset if AL20 = 0 Always automatic reset if AL20 =16 From automatic to manual reset if AL20 =1..15	0	16		
Pump down alarm					
AL 21	Maximum number of pump down alarm events per hour in stop condition. After this number the alarm is logged, displayed and signalled with alarm relay + buzzer. Manual reset if AL21 = 0 Automatic reset if AL21 =16 From automatic to manual reset if AL21 =1..15	0	16		
AL 22	Maximum number of pump down alarm events per hour in start-up condition. After this number the alarm is logged, displayed and signalled with alarm relay + buzzer. Always manual reset if AL22 = 0 Always automatic reset if AL22 =16 From automatic to manual reset if AL21 =1..15 and parameter AL23 config.	0	16		
AL 23	Select if the pump down alarm must change from automatic to manual reset: 0= Always automatic reset 1= Manual reset after AL21 alarm events	0	1		
Anti-freeze alarm in Chiller mode					
AL 24	Minimum antifreeze setpoint in chiller (from -30 °C to AL24)	-30.0 -22	AL24	°C °F	Dec int
AL 25	Maximum antifreeze setpoint in chiller (from AL24 to 70 °C)	AL24	70.0 158	°C °F	Dec int
AL 26	Setpoint temperature for low anti-freeze alarm, low ambient temperature (air/air), low temperature air outlet (air/air). From AL24 to AL25.	AL24	AL25	°C/°F	Dec/int
AL 27	Differential of alarm reset in Chiller mode for anti-freeze, low ambient air temperature or low outlet air temperature alarms.	0 0	25.0 45	°C °F	Dec int
AL 28	Alarm delay for anti-freeze, low ambient air temperature or low outlet air temperature. The temperature must be lower than AL26 for this time duration before having the alarm event.	0	250	Sec	
AL 29	Maximum number of alarm events anti-freeze, low ambient air temperature or low outlet air temperature before changing from automatic to manual alarm reset: Always manual reset if AL29 = 0 Always automatic reset if AL29 = 16 From automatic to manual if AL29 = 1..15	0	16		
AL 30	Anti-freeze alarm configuration in chiller 0= to turn the compressors off when the anti-freeze control probe is lower than AL26 (after the time delay), the display shows the alarm label. Buzzer and Alarm relay are not activated. 1= to turn the compressors off when the anti-freeze control probe is lower than AL26 (after the time delay), the display shows the alarm label. Buzzer and Alarm relay are activated.	0	1		
Anti-freeze alarm in Heat pump mode					
AL 31	Setpoint of the minimum limit in heat pump (va da - 30 °C a AL32)	-30.0 -22	AL31	°C °F	Dec int
AL 32	Setpoint of the maximum limit in heat pump (va da AL31 a 70 °C)	AL31	70.0 158	°C °F	Dec int
AL 33	Anti-freeze alarm setpoint in heat pump Setpoint temperature for low anti-freeze alarm, low ambient temperature (air/air), low temperature air outlet (air/air). (from AL31 to AL32)	AL31	AL32	°C/°F	Dec/int
AL 34	Alarm differential in heat pump. To reset the anti-freeze, low ambient Temperature (air/air), low temperature air outlet (air/air) alarms.	0 0	25.0 45	°C °F	Dec int

AL 35	Anti-freeze alarm delay in HP for low outlet air temperature (air/air) Attention If during the Stand-by or remote off there is an anti-freeze alarm event, and the AL35 <>0, starting the heat pump mode, from keyboard or digital input. In this case the anti-freeze alarm is aborted and the compressor starts for the AL35 time to heat the air or the water. After the AL35 time if the antifreeze probe value is still lower than AL33 setpoint, for maximum AL36 seconds, the unit is stopped and the anti-freeze alarm is generated again.	0	250	Sec	
AL 36	Anti-freeze alarm delay for low air ambient temperature or low outlet air temperature in heat pump normal condition. The detected temperature must be lower than AL33 for the time AL36 before giving the alarm	0	250	Sec	
AL 37	Maximum number of anti-freeze alarm events for low air ambient temperature or low outlet air temperature in heat pump. It sets the alarm reset condition: Always manual reset AL37 = 0 Always automatic reset AL37 = 16 From automatic to manual reset if AL37 = 1..15	0	16		
AL 38	Anti-freeze alarm configuration in heat pump 0= to turn the compressors off when the anti-freeze control probe is lower than AL33 (after the time delay), the display shows the alarm label. Buzzer and Alarm relay are not activated. 1= to turn the compressors off when the anti-freeze control probe is lower than AL33 (after the time delay), the display shows the alarm label. Buzzer and Alarm relay are activated.	0	1		
Compressor high discharge temperature					
AL 39	Compressor high discharge temperature setpoint	0 0	150 302	°C °F	Dec / int int
AL 40	Compressor high discharge temperature differential	0 0	25.0 45	°C °F	Dec int
AL 41	Number of compressor high discharge temperature events per hour to determine the alarm reset condition: Always manual reset if AL41 = 0 Always automatic reset if AL41 = 16 From automatic to manual if AL41 = 1..15	0	16		
AL 42	Maximum number of generic alarm events (each event stop the regulation) before turning the alarm from automatic to manual: Always manual AL42 = 0 Always automatic AL42 = 16 From manual to automatic if AL42 value is between 1 and 15	0	16		
AL 43	Generic alarm delay time after the digital input activation	0	250	Sec	
AL 44	Generic alarm delay time after the digital input is not activate	0	250	10 sec	10 sec
Alarm relay					
AL 45	Enable alarm relay with unit in off or stand – by: 0= Alarm output not enabled 1= Alarm output enabled	0	1		
Password reset: Alarm log – Compressor overload					
AL 46	Password value to reset the alarm log or the compressor overload alarm.	0	999		
AL 47	Thermal alarm of the compressor 0= lock the compressor 1= lock the whole circuit	0	1		
Pr1	Password	0	999		
Pr2	Password	0	999		
Pr3	Password	0	999		

10 PROGRAMMING WITH THE “HOT KEY 64”

10.1 DOWNLOAD: HOW TO PROGRAM AN INSTRUMENT WITH A PROGRAMMED “HOT KEY”

1. Turn off the instrument supply
2. Insert the hot key.
3. Turn on the power supply.
4. Immediately the parameters are downloaded.

During the download the regulation is locked and the top display shows the “doL” blinking label. At the end of the download will appear:

“End” if the programming procedure is completely OK, after 30seconds the regulation starts automatically.

“Err” if the programming procedure has found an error and the parameter have not been transferred. In this case turn off and then on the instrument supply to repeat the operation or remove the hot key, with power supply off, to restart the regulation.

10.2 UPLOAD: HOW TO PROGRAM A "HOT KEY" WITH THE PARAMETERS OF THE INSTRUMENT

1. Turn on the power supply.
 2. Insert the hot key.
 3. Enter the function Menu.
 4. Select the **UPL** function (on the bottom display).
 5. Push **SET** key and immediately the instrument starts transfer the parameters into the Hot key.
- During the upload the regulation is locked and the top display shows the "**UPL**" blinking label. At the end of the UPLOAD will appear: "**End**" if the programming procedure is completely OK, after 30seconds the regulation starts automatically. "**Err**" if the programming procedure has found an error and the parameter have not been transferred. Repeat the procedure. To exit the UPL function push the MENU key or wait the time-out (15 sec).

11 PROGRAMMING USING THE KEYBOARD

Through the instrument keyboard it is possible to enter the programming. In all the three accessible levels the user can show and modify both value and visibility of the parameters. To ensure an easy navigation through the different levels the common parameters have been named and grouped under a family name.

The three levels of programming:

- Pr1 User level
- Pr2 Maintenance level
- Pr3 OEM level

11.1 PASSWORD DEFAULT VALUES

- Password level Pr1 = 1
- Password level Pr2 = 2
- Password level Pr3 = 3

Under the function Menu (to reset the Alarm Log or the Compressor Overload) the password is 0 (see parameter AL46) Each password can be changed, the range is from 0 to 999.

Each parameter has two level: visibility and modify. Therefore it can be configured as follow:

- The parameter can be showed and changed.
- The parameter can be showed but not changed.

11.2 ENTER THE PR1 - PR2 - PR3 PROGRAMMING LEVELS

Pr1 LEVEL:

Push **SET + DOWN** together for 3 seconds, the top display shows the PAS label and the bottom display shows the Pr1 label. The leds cir1/cir2 are blinking (up and down leds) to inform that you now are in PR1 programming level.

Pr2 LEVEL:

From the Pr1 level push the UP key for 2 seconds and the bottom display will show Pr2. The top display still shows PAS.

Pr3 LEVEL:

From the Pr2 level push the UP key for 2 seconds and the bottom display will show Pr3. The top display still shows PAS.

After selecting the level push the SET key and the top display will show the 0 blinking value where to insert the password .

Set the password level using the UP and DOWN keys then confirm with SET key.

Dependening on the password value there will be the different level access, if the password is wrong the instrument shows the password value again.

ATTENTION:

For all the programming levels Pr1,2,3: the CF family (or configuration parameters) can not be changed if the unit is running in chiller, heat pump. The user can check the leds #1 and #2 and if they are blinking it is not possible to change this parameters but it is necessary to set the unit in stand-by and then enter the programming again.

During the defrost the dF family can't be programmed.

11.3 HOW TO CHANGE A PARAMETER VALUE

Enter the programming

1. Push the **SET + DOWN** keys together for 3 seconds;
2. Select the parameter label with up and down keys;
3. Push **SET** to enter the parameter value;
4. Change the value with **UP** or **DOWN** keys;
5. Push "**SET**" to confirm, after some seconds the display shows the next parameter;
6. Exit: Push **SET + UP** together when a parameter label is displayed or wait 15seconds without pushing a key.

NOTE: a new parameter value is confirmed also after the 15 seconds of timeout is expired (without pushing SET key to confirm).

11.4 CHANGE THE PASSWORD VALUE

Pr1 LEVEL

Remember that it is necessary to know the old password value.

- 1) Enter the Pr1 level
- 2) Select a parameter family.

- 3) Inside the family select the "Pr1 - 1", Pr1 on the bottom display, the current password value 1 on the top display. Push the SET key to change the value that now is blinking.
- 4) Use the UP or DOWN key to insert the NEW PASSWORD value, then push SET to confirm the new value.
- 5) The top display blinks for some seconds and then shows the next parameter.
- 6) Exit the programming pushing SET + UP together or wait the timeout.

Pr2 LEVEL

Remember that it is necessary to know the old password value.

1. Enter the Pr2 level
2. Select a parameter family.
3. Inside the family select the "Pr2 - 2", Pr2 on the bottom display, the current password value 2 on the top display. Push the SET key to change the value that now is blinking.
4. Use the UP or DOWN key to insert the NEW PASSWORD value, then push SET to confirm the new value.
5. The top display blinks for some seconds and then shows the next parameter
6. Exit the programming pushing SET + UP together or wait the timeout.

Inside the Pr2 level it is possible to change also the Pr1 password.

Pr3 LEVEL

Remember that it is necessary to know the old password value.

1. Enter the Pr3 level
2. Select a parameter family.
3. Inside the family select the "Pr3 - 3", Pr3 on the bottom display, the current password value "3" on the top display. Push the SET key to change the value that now is blinking.
4. Use the UP or DOWN key to insert the NEW PASSWORD value, then push SET to confirm the new value.
5. The top display blinks for some seconds and then shows the next parameter
6. Exit the programming pushing SET + UP together or wait the timeout.

Inside the Pr3 level it is possible to change also the Pr1 and Pr2 passwords.

11.5 ENTER THE PROGRAMMING LEVEL PR1

Enter the Pr1 "User level ":

1. Push the **SET + DOWN** keys together for 3 seconds. The top display shows PAS while the bottom display shows Pr1 labels.
2. Push **SET** key and the top display shows a blinking 0, with **UP** or **DOWN** insert the Pr1 password. Push **SET** and, if the value is correct, top display will show the first family of parameters "**ALL**". Otherwise set the password again.
3. Select a parameter family with **DOWN** or **UP** keys.
4. Push **SET** to enter, the bottom display shows the first available parameter label while the top display shows its value.

The user can shows and modify all the parameters belonging to this family.

Parameter status, leds and bottom display in Pr1

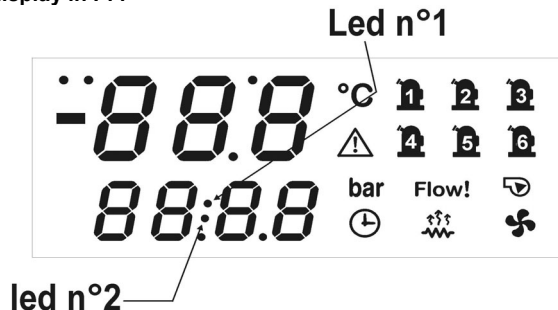

- If the selected parameter can not be changed the leds 1 and 2 are blinking.
- In Pr1 level the user can not see and change any parameter of Pr2 and Pr3.
- The MENU key allows to exit from a family to reselect another without exit the Pr1 level.
- To exit completely the programming push SET + UP.

11.6 ENTER THE PROGRAMMING LEVEL PR2

Enter the Pr2 "maintenance level ":

1. Push the **SET + DOWN** keys together for 3 seconds. The top display shows PAS while the bottom display shows Pr1 labels.
2. Push UP key for 2 seconds and the top display will show Pr2.
3. Push **SET** key and the top display shows a blinking 0, with **UP** or **DOWN** insert the Pr2 password. Push **SET** and, if the value is correct, top display will show the first family of parameters "**ALL**". Otherwise set the password again.
4. Select a parameter family with **DOWN** or **UP** keys.
5. Push **SET** to enter, the bottom display shows the first available parameter label while the top display shows its value.

The user can shows and modify all the parameters belonging to this family.

Parameter status, leds and bottom display in Pr2

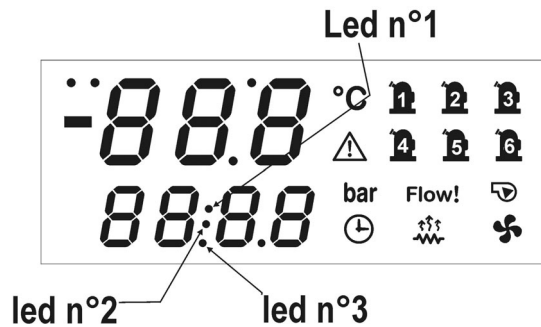

- Leds 1 / 2 are blinking: the parameter can not be changed.
- All the leds are off: the parameter ca not be seen in Pr1 level.
- Led 3 is on: the parameter can be seen in Pr1 level.
- Leds 1 / 2 are blinking and led 3 is on: the parameter can be showed and changed in Pr2, showed but not changed in Pr1.
- Leds 1 / 2 / 3 are blinking: the parameter can be showed and changed in Pr2 and in Pr21.
- In Pr2 level the user can not see and change any parameter of Pr3 level.
- The MENU key allows to exit from a family to reselect another without exit the Pr2 level.
- The MENU key allows to pass to Pr1 starting from a family label.
- To exit completely the programming push SET + UP.

11.7 ENTER THE PROGRAMMING LEVEL PR3

Enter the Pr3 "OEM level ":

1. Push the **SET + DOWN** keys together for 3 seconds. The top display shows PAS while the bottom display shows Pr1 labels.
2. Push UP key for 2 seconds and the top display will show Pr2.
1. Push UP key again for 2 seconds and the top display will show Pr3
3. Push **SET** key and the top display shows a blinking 0, with **UP** or **DOWN** insert the Pr3 password. Push **SET** and, if the value is correct, top display will show the first family of parameters "ALL". Otherwise set the password again.
4. Select a parameter family with **DOWN** or **UP** keys.
5. Push **SET** to enter, the bottom display shows the first available parameter label while the top display shows its value. The user can shows and modify all the paramters belonging to this family.

Parameter status, leds and bottom display in Pr3

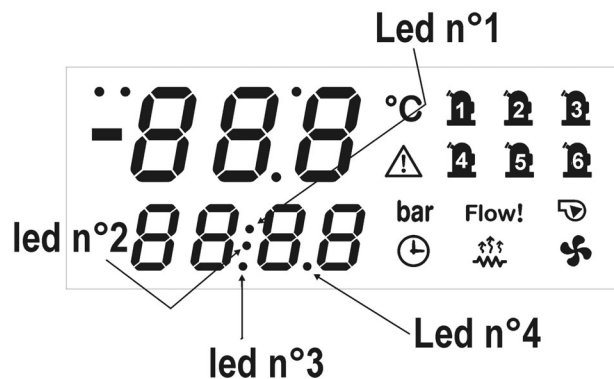

- Leds 1 / 2 are blinking: the parameter can not be changed.
- All the leds are off: the parameter is available only in Pr3.
- Led 4 on: the parameter can be changed also in Pr2.
- Led 4 blinking: the parameter is visible also in Pr2 .
- Leds 3 / 4 on: the parameter is available in Pr2 and in Pr1.
- Leds 3 / 4 blinking: the parameter is visible in Pr1 and in Pr2.
- The MENU key allows to exit from a family to reselect another without exit the Pr2 level.
- The MENU key allows to pass to Pr1 starting from a family label.
- To exit completely the programming push SET + UP.

11.8 MOVE A PARAMETER LEVEL FROM PR2 TO PR1

Enter Pr2 programming level

Select the parameter and if the led # 3 is off: the parameter is available only in Pr2.

To show the parameter also in Pr1:

1. Keep pushed SET key;
2. Push 1 time the DOWN key and the led 3 should be on, the parameter is now available in Pr1.

To hide the parameter in Pr1:

1. Keep pushed SET key;
2. Push 1 time the DOWN key and the led 3 should be off, the parameter is now removed from Pr1.

11.9 MOVE A PARAMETER FROM Pr3 TO Pr2 TO Pr1

Enter Pr3 programming level, here the parameter are all visible:

Select the parameter, if all the leds are off the parameter is available only in Pr3.

To show the parameter also in Pr2 and Pr1:

1. Keep pushed SET key;
2. Push 1 time the DOWN key and the leds 3 and 4 should be on, the parameter is now available also in Pr2 / Pr1.

To show the parameter only in Pr2:

1. Keep pushed SET key;
2. Push 1 time the DOWN key and the leds 3 is off, the parameter is now available also in Pr2.

To show the parameter only in Pr3:

1. Keep pushed SET key
2. Push 1 time the DOWN key and the leds 3 and 4 are off, the parameter is now available only in Pr3.

11.10 VISIBILITY AND PARAMETER VALUE LOCKED

To set the only visibility and lock the parameter value it is necessary enter Pr3 programming level.

Pr1 PARAMETER VISIBILITY

Enter the Pr3 level

1. Select the parameter;
2. Keep pushed the SET key;
3. Push 1 time the MENU key and the led 3 change from on to blinking: the parameter is visible in Pr1 but can't be changed.

Pr2 PARAMETER VISIBILITY

Enter the Pr3 level

1. Select the parameter;
 2. Keep pushed the SET key;
 3. Push 1 time the MENU key and the led 4 change from on to blinking the parameter is visible in Pr2 but can't be changed.
- Leds 3 / 4 blinking: the parameter is visible in Pr1 and in Pr2 but in those levels now they can't be changed.

TO SET THE ORIGINAL TAG FOR THE PARAMETER Pr1 / Pr2

1. Keep pushed the SET key;
2. Push one time the MENU key, the leds 3 / 4 turn on, the parameter can be seen and modified in Pr1 and Pr2.

11.11 PROGRAMMING: DIGITAL INPUT AND OUTPUT POLARITY

The parameters that allow to configure different options such as:

1. Digital inputs
2. Digital outputs (relay)
3. Proportional output configured as ON/OFF
4. Analogue input configured as digital input

have a different parameter description that allows to configure the operating mode and the corresponding polarity.

Example of programming:

The bottom display shows the parameter label (CF36) Digital input ID1 configuration;

Note that the top display shows "c" or "o" before the configuration number.

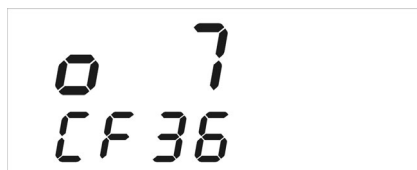

The selection 7 for the digital input ID1 (CF36) means that it is the "high pressure switch of circuit 1".

The label "o" means that the digital input is active for **open** contact.



Otherwise if the selection is 7 for the digital input ID1 (CF36) = "high pressure switch of circuit 1".

The label "c" means that the digital input is active for **closed** contact.

11.12 CHANGE THE POLARITY OF THE DIGITAL INPUTS-OUTPUTS

Enter the programming:

1. Select a parameter with digital input/output value, The top display shows the label o before the configuration number while the bottom display shows the parameter label.
2. Push SET key: the o label and the configuration number are blinking, use the UP or DOWN key and select the proper polarity (o / c) of the function, then push SET key to confirm it all.
3. The top display blinks for some seconds and then it will shows the next parameter.
4. To exit the programming push SET + UP together or wait the timeout (15seconds).

12 SELECTION AND START OF THE RUNNING MODE

12.1 SELECT THE CHILLER OR THE HEAT PUMP MODE

The CF79 parameter allows to select and enable the running mode:

Par. CF79 = 0: Through keyboard, the user can start and stop the unit using the keys of the front panel.

Par. CF79 = 1: Through digital input programmed to start/stop the unit from remote control.

- This selection is enabled if there is one digital input configured as start/stop from remote (remote chiller / heat pump). If none of the digital input are configured the unit remains in **stand-by**.
- The "open" status of the input forces the chiller running mode.
- The "closed" status of the input forces the heat pump running mode.
- The keyboard selection is disabled.
- The key on the front panel can start/stop the unit only with the digital input selection

Par. CF79 =2: Automatic selection of the Chiller - Heat Pump through analogue input

The analogue input selection or change over function overrides the digital input C-HP function. If the external air temperature are within the CF81 differential, the user can change the running mode from the keyboard.

If the unit is running with CF79 = 1 or CF79=2, and it is requested a running mode change, the controller turns off all the outputs, starts a fixed delay time signalled by the chiller or heat pump blinking led. This blinking led indicates which running mode will be activated after the compressor delay time protection.

12.2 CHANGE OVER

To change the running status the following condition must be respected otherwise the unit remains in **stand - by**:

1. CF02=1 (heat pump selected)
2. CF79=2 and a NTC probe configured as NTC external air temperature for dynamic setpoint/ boiler / change over
3. This probe is working properly.

Parameters involved with the change over function:

CF80 Change over Setpoint. If the analogue input control (from probe) function is enabled, it represents the limit temperature of the probe value under which the unit runs the Heat Pump mode.

CF81 Change over Differential. If the analogue input control (from probe) function is enabled, it represents the limit differential temperature of the probe value to restart in the Chiller mode.

For external air temperature within CF81 the user can manually change the status from keyboard.

GRAPH: AUTOMATIC CHANGE OVER

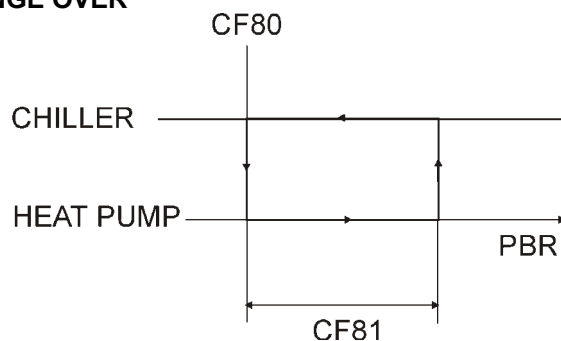

12.3 CHILLER – HEAT PUMP FUNCTIONING MODE



IT IS DEFINED BY THE PARAMETER CF78.



12.4 KEYBOARD SELECTION

CF78 = 0: pushing  key the unit starts in chiller, pushing  key the unit starts in heat pump

CF78 = 1: pushing  key the unit starts in heat pump, pushing  key the unit starts in chiller

12.5 ANALOG INPUT SELECTION

CF78 = 0 NTC, External air temperature probe > CF80+ CF81  the unit starts in chiller, NTC, External air temperature probe < CF80  the unit starts in heat pump.

CF78 = 1 NTC, External air temperature probe > CF80+ CF81  the unit starts in chiller, NTC, External air temperature probe < CF80  the unit starts in heat pump.

13 UNIT START- STOP

The unit start stop can be done from one of the following operations:

- From keyboards
- RTC Time table
- Digital input configured as remote ON/OFF

13.1 START – STOP AND STAND-BY FROM KEYBOARD

TURN THE UNIT ON IN CHILLER OR HEAT PUMP MODE FROM THE KEYBOARD



Push and release the

key allows to start in chiller mode if CF78 =0, in heat pump if CF78 =1. When the unit is running the

corresponding led is on.

IMPORTANT: To change from chiller to heat pump and viceversa the unit must be set in stand-by before continuing.



Push and release the

key allows to start in heat pump mode if CF78 =0, in chiller if CF78 =1er. When the unit is running the

corresponding led is on.

IMPORTANT: To change from chiller to heat pump and viceversa the unit must be set in stand-by before continuing.

STAND-BY (OR UNIT OFF, NOT RUNNING)



The unit is considered in stand by when the leds and the Heat Pump are turned off. During the stand by the user can:

- Show all the probe measurements
- Detect and reset the alarm events.

are both off. The stand-by is reached each time the Chiller or

13.2 UNIT START- STOP FROM DIGITAL INPUT

Turn on or off the unit from digital input

Set the digital input as remote ON/OFF, depending on the input polarity it can generate the unit off

- The digital input overrides the keyboard command.
- The keyboard can run only if the digital input is not active.
- When the digital input is not active the instrument restore its status (had before the digital input activation).

14 DISPLAY LAYOUT

As default, In normal condition, the display shows the circuit 1 information.

The displayed circuit is indicated from the corresponding led **Cir1** on (UP key), or **Cir2** (circuit 2, DOWN key).

14.1 HOW TO SHOW THE MEASUREMENT LIST.

With the led Cir1 on, push UP or Down keys to display the labels of the information of the circuit 1.

With the led Cir2 on, push UP or Down keys to display the labels of the information of the circuit 2.

Each measurement is defined by a label that indicates which if it is a pressure a temperature or a time.

14.2 SHOW THE CIRCUIT 1 OR 2

To swap between the information of the two circuits use the UP and DOWN key to select a label then push SET, check the led.

Example in fig.1

Led cir1 is on: the top display shows the value of the output evaporator temperature (7.8°C) of the circuit 1,

The bottom display shows Out 1. Push SET key to swap to the circuit 2. **Fig2**

Led cir2 is on: the top display shows the value of the output evaporator temperature (7.9°C) of the circuit 2, the bottom display shows Out 2.

Fig.1

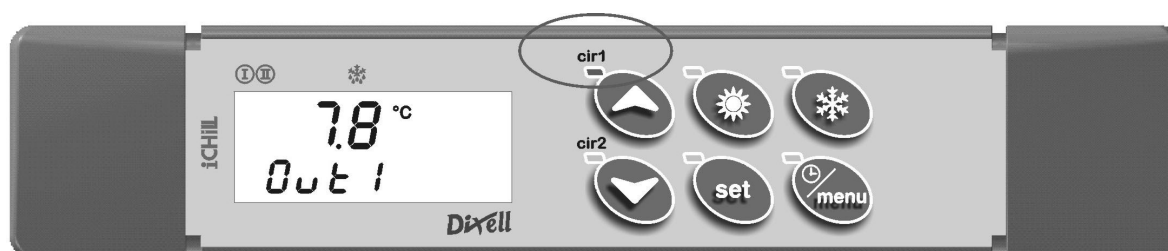
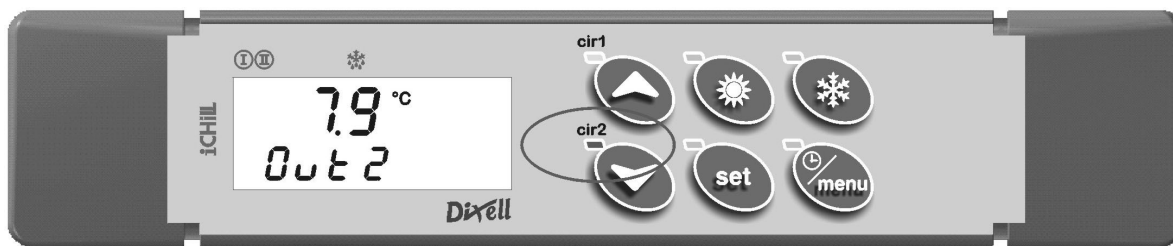
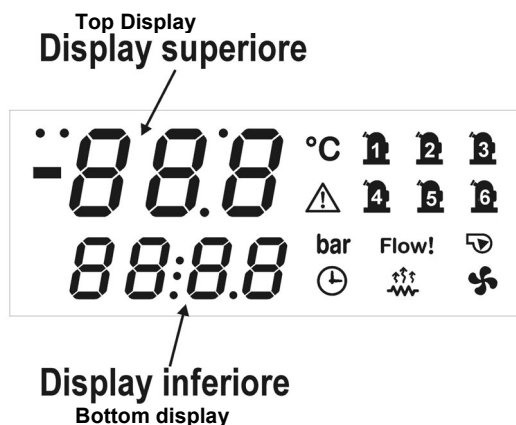

Fig.2



15 CUSTOM DISPLAY

The dP family of parameters allows to set a custom display read-out. The user can change the default read-out (both for instrument and remote terminals) of the measurements depending on the application.



15.1 DEFAULT READ - OUT OF THE TOP DISPLAY

To set the default value displayed on the top display:

1. Set the parameter dP03 = 0, it means configurable;
2. Select the dP01 parameter into the range 0..14 described here below:

PARAMETER VALUE	DESCRIPTION	CORRESPONDING LABEL
dP01=0	No display read out	No label
dP01=1	NTC temperature probe of the evaporator water inlet	Ein
dP01=2	NTC temperature probe of the evaporator water outlet 1 and 2	Out1 circuit 1 Out2 circuit 2
dP01=3	NTC temperature probe of the uscita common evaporator water outlet	Eout
dP01=4	NTC temperature probe of the condenser water inlet	Cin1 circuit 1 Cin2 circuit 2
dP01=5	NTC temperature probe of the common condenser water inlet	Cin
dP01=6	NTC temperature probe of the condenser water outlet	Cou1 circuit 1 Cou2 circuit 2
dP01=7	NTC temperature probe of the common condenser water outlet	Cout
dP01=8	NTC temperature probe of the dynamic external air setpoint	Et
dP01=9	NTC temperature probe of the free cooling water inlet	FCIn
dP01=10	NTC temperature probe of the free cooling external air value	FCEt
dP01=11	NTC temperature probe of the remote terminal 1	trt1
dP01=12	NTC temperature probe of the remote terminal 2	trt2

dP01=13	NTC temperature probe of the combined defrost	dEF1 circuit 1 dEF2 circuit 2
dP01=14	NTC temperature probe of the condenser	Cdt1 circuit 1 Cdt2 circuit 2

15.2 DEFAULT READ - OUT OF THE BOTTOM DISPLAY

To set the default value displayed on the bottom display:

1. Set the parameter dP03 = 0, it means configurable;
2. Select the dP02 parameter into the range 0..17 described here below:

PARAMETER VALUE	DESCRIPTION	CORRESPONDING LABEL
dP02=0	No display read out	No label
dP02=1	NTC temperature probe of the evaporator water inlet	Ein
dP02=2	NTC temperature probe of the evaporator water outlet 1 and 2	Out1 circuit 1 Out2 circuit 2
dP02=3	NTC temperature probe of the common evaporator water outlet	Eout
dP02=4	NTC temperature probe of the condenser water inlet	CIn1 circuit 1 CIn2 circuit 2
dP02=5	NTC temperature probe of the common condenser water inlet	Cin
dP02=6	NTC temperature probe of the condenser water outlet	Cou1 circuit 1 Cou2 circuit 2
dP01=7	NTC temperature probe of the common condenser water outlet	Cout
dP02=8	NTC temperature probe of the dynamic external air setpoint	Et
dP02=9	NTC temperature probe of the free cooling water inlet	FCIn
dP02=10	NTC temperature probe of the free cooling external air value	FCEt
dP02=11	NTC temperature probe of the remote terminal 1	trt1
dP02=12	NTC temperature probe of the remote terminal 2	trt2
dP02=13	NTC temperature probe of the combined defrost	dEF1 circuit 1 dEF2 circuit 2
dP02=14	NTC temperature probe of the condenser	Cdt1 circuit 1 Cdt2 circuit 2
dP02=15	Pressure probe of the condenser 4+20mA - 0.5V	Cdt1 circuit 1 Cdt2 circuit 2
dP02=16	Pressure probe of the evaporator 4+20mA - 0.5V	LP1 circuit 1 LP2 circuit 2
dP02=17	Clock	

TOP DISPLAY: CUSTOM EXAMPLE

Parameter dP01=01. The default read out for the circuit 1 and the circuit 2 is the NTC probe value of the evaporator water inlet.

Parameter dP01=02. The default read out for the circuit 1 is the evaporator outlet 1 temperature, while for the circuit 2 is the evaporator 2 outlet temperature.

BOTTOM DISPLAY: CUSTOM EXAMPLE

Parameter dP02=03. The default read out for the circuit 1 and the circuit 2 is the NTC probe value of the evaporator water outlet.

Parameter dP02=14. The default read out for the circuit 1 is the condenser 1 temperature, while for the circuit 2 is the condenser 2 temperature.

15.3 FORCED READ - OUT OF THE TOP AND BOTTOM DISPLAY

To force the display read-out:

1. Set the dP03 parameter not equal to 0
2. Select the value range 1..3

These configurations allow to show together two temperatures or two pressures of the same circuit in order to have an easier reading of the measurements:

Par. dP03 = 1

Top display: for both the circuits 1,2:

- Evaporator water inlet, with the **Ein** label.

Bottom display: circuit 1:

- Evaporator 1 water outlet, with the label **Out1**

Bottom display: circuit 2:

- Evaporator 2 water outlet, with the label **OuT2**.

Par. **dP03 = 2****Top display of the circuit 1:**

- Condenser 1 water inlet temperature with the label **CIn1**

Bottom display of the circuit 1

- Condenser 1 water outlet with the label **COu1**.

Top display of the circuit 2:Condenser 2 water inlet temperature with the label **Cin2****Bottom display of the circuit 2**

- Condenser 2 water outlet with the label **Cou2**.

Par. **dP03 = 3****Top display of the circuit 1:**

- Condenser probe temperature **Cdt1** / pressure **CdP1**

Bottom display of the circuit 1

- Evaporator pressure probe **LP1**

Top display of the circuit 2:Condenser probe temperature **Cdt2** / pressure **CdP2****Bottom display of the circuit 2**Evaporator pressure probe **LP2**

15.4 DEFAULT DISPLAY READ - OUT OF THE REMOTE PANELS VI620S AND VI820S

If the parameter dP04 = 0 the upper display of the remote panels #1 and #2 depends on the parameter values dP01 – dP02 – dP03; to show the temperature detected by the internal probe of the remote panel accessing the function menu under the function trEm.

If the parameter dP04 = 1 the upper display of the remote panels #1 and #2 show their internal NTC sensor (ambient temperature); to show the same temperature it is possible to access the function menu under the function trEm.

15.5 DEFAULT DISPLAY READ - OUT OF THE REMOTE PANELS VI620S AND VI820S

If the parameter dP04 = 0 the upper display of the remote panels #1 and #2 depends on the parameter values dP01 – dP02 – dP03; to show the temperature detected by the internal probe of the remote panel accessing the function menu under the function trEm.

If the parameter dP04 = 1 the upper display of the remote panels #1 and #2 show their internal NTC sensor (ambient temperature); to show the same temperature it is possible to access the function menu under the function trEm.

16 DISPLAY INFORMATION

16.1 SHOW THE SET POINT VALUE

Push and release the **SET** key, the leds of the circuits are off and the set value is displayed.

In stand-by the bottom display shows **SetC** (set chiller), by pushing SET again the next label is **SetH** (set heat pump).

If the unit is running the only set displayed is related to the running mode.

16.2 MODIFY THE SET POINT

- 1) Push **SET** key for at least **3** seconds: the leds of the circuits are off and the set value is blinking.
- 2) Use the **UP** or **DOWN** key to modify the setpoint.
- 3) Push **SET** to confirm or wait the timeout (15seconds).

16.3 SHOW THE ACTIVE SETPOINT DURING ENERGY SAVING OR DYNAMIC SETPOINT

If the unit is running in chiller or HP, the Energy Saving or the Dinamic Setpoint activity is signalled by the blinking led of the SET button.

Chiller mode: push **SET** one time, the bottom display shows the **SEtC** (set chiller) while the top display shows the set value. Only if the Energy saving or the Dynamic Setpoint are active, pushing another time the **SET** key, the bottom display shows “**SEtr**” (real setpoint), and the top display shows the setpoint that the unit is really using for the thermoregulation.

Chiller mode: push **SET** one time, the bottom display shows the **SEtH** (set Heat pump) while the top display shows the set value. Only if the Energy saving or the Dynamic Setpoint are active, pushing another time the **SET** key, the bottom display shows “**SEtr**” (real setpoint), and the top display shows the setpoint that the unit is really using for the thermoregulation.

ATTENTION

The **SEtr** label appears only if the Energy saving or the Dynamic Setpoint are active.

To modify the working setpoint it is necessary the setpoint values is displayed on both the display (temperature / temperature or temperature / pressure o pressure/ pressure) without any identification label, otherwise the SET key swaps to the circuit information.



16.4 DISPLAY IN REMOTE OFF

From digital input configured as remote ON/OFF: the active input sets the unit in OFF (even when the unit is a motocondensing unit). The top display shows "OFF", the led of the decimal point is blinking.

16.5 DISPLAY IN MOTOCONDENSING CONFIGURATION

The top display shows "ON" for active input and "OFF" for not active input. If the unit is running in Chiller the top display shows **OnC** otherwise **OnH** for heat pump.

The configuration for motocondensing, as for chiller or HP, allows to show through the top and the bottom display all the detected input measurements and alarms.

17 FUNCTION MENU " M " KEY

The function Menu is composed of the following items:

- 1) Show and reset the alarms **ALrM**
- 2) Compressor overload alarm reset **COtr**
- 3) Show and reset the alarm log **ALOG**
- 4) Upload the parameter into the Hot Key **UPL**
- 5) Enable – disable one or the two circuits **CrEn**
- 6) Enable – disable one of the compressors **COEn**
- 7) Display the compressor discharge temperature **COdt**
- 8) Show and reset the number of compressor running hour **Hour**
- 9) Show and reset the number of compressor starts-up **COSn**
- 10) Show the condensing fan speed percentage of the proportional output **Cond**
- 11) Show the percentage of the proportional output 0 ÷ 10 Vdc **Pout**
- 12) Time counting to next defrost cycle, under heat pump mode, **dF**
- 13) Show the probe temperatures that enabled to control the auxiliary output **uS**
- 14) Show the probe the temperature of the remote panels **trEM**

MENU FUNCTION ACCESS: Push and release the **M** key.

MENU FUNCTION ACCESS: Push and release the **M** key or wait the 15seconds timeout limit.

With the **UP** or **DOWN** keys move inside the label list.

17.1 ALARM LIST: SHOW AND RESET

ALrM FUNCTION

Enter the function MENU pushing M key one time

- 1) Use the **UP** or **DOWN** to select the ALrM label
- 2) Push **SET** key (Nothing happens if there are no active alarm events)
- 3) Bottom display: alarm label code. Top display: label **rSt** to reset or **NO** if it is not possible.
- 4) Use the **UP** or **DOWN** to scroll the alarm list.
- 5) Pushing SET when the rSt label is displayed the corresponding alarm will be reset, then the display shows next alarm in the list, pushing SET again the alarm is reset and the display shows next alarm etc. Nothing happens by pushing SET when the label NO is displayed, in this case push UP or DOWN to move to another alarm label.
- 6) To exit the ALrM reset function push MENU one time or wait the timeout.

17.2 COMPRESSOR OVERLOAD ALARM RESET

COtr function resets the compressor overload alarm event.

Within the COtr function all the active compressor overload alarms are displayed in a list.

Labels involved in COtr: **CO1r = compressor 1 overload reset ... CO6r = compressor 6 overload reset**. Labels CO1r – CO2r – CO3r – CO4r – CO5r – CO6r are available if the digital inputs have been previously configured.

ATTENTION

In the **COtr** function the alarm is displayed only after the number of events per hour have reached the Par. AL20 value, only after that number of events per hour the alarm becomes **MANUAL**.

MANUAL ALARM RESET PROCEDURE

Enter Menu function

1. Use **UP** or **DOWN** key and select the COtr on the bottom display.
2. Push **SET** one time, if there are active alarms the bottom display shows the alarm label eg. CO1r (for compressor 1) while the top display shows the label rSt to reset the alarm or NO if the alarm can not be reset. Use the UP or DOWN keys to scroll all the alarm list.
3. Nothing happens by pushing SET when the label NO is displayed.
4. Pushing SET when the rSt label is displayed the corresponding alarm will be reset after the password: bottom display = ArSt while the top display = PAS.
5. Push SET and the top display blinks 0 while the bottom shows PAS. Insert the password using UP or DOWN key (see AL parameter family). If the password is OK the ArSt blinks for per 3seconds, if the password value is not correct the top display blinks 0 while the bottom shows PAS. If within 5 seconds no value is inserted the display label come back to CO1r function.
6. To exit the COtr function push MENU or wait the timeout.

- Repeat operation 1 – 5 to reset the other alarms.

17.3 COMPRESSOR OVERLOAD PASSWORD.

The default value is 0 to change this value enter Pr3 level under the AL parameter family (Par. AL43)

17.4 ALARM LOG LIST

ALOG FUNCTION TO SEE THE ALARM LOG

The function and the alarm codes are visible only if there are alarm events. If many events are active at the same time the list displayed by increasing order.

Enter the function Menu

- Select ALOG
- Push **SET** one time. Nothing happens if there are no active alarm events.
- The bottom display shows the alarm label, the top display shows the a number in the range 00 to 99.
- Use the UP or DOWN keys to scroll the list.
- To exit the ALOG function push MENU or wait the timeout.

17.5 ERASE THE ALARM LOG LIST

ALOG FUNCTION TO ERASE THE LOG LIST

- Enter the function Menu.
- Use the **UP** or **DOWN** keys to select ALOG on the bottom display.
- Push on e time the **SET** key.
- Within the ALOG function select with **UP** or **DOWN** keys, the **ArSt** label on the bottom display while the top display shows PAS.
- Push **SET**: the bottom display shows **PAS** and the top display a blinking 0.
- Insert the password (See parameter family AL)
- If the password is OK the label **ArSt** blinks for 5 seconds then the display returns to normal condition read-out (probes).
- If the password is not correct the display shows **PAS** again. in any case is possible to scroll the list with **UP** or **DOWN**
- To exit push the M key one time or wait the timeout.

17.6 PASSWORD VALUE OF THE ALARM LIST

The default value is 0 to change this value enter Pr3 level under the AL parameter family.

THE ALARM LIST CONTAINS 100 EVENTS IN A FIFO STRUCTURE. WHEN THE MEMORY IS FULL ANY NEW ALARM WILL ERASE THE OLDEST.

17.7 DISABLE – ENABLE A SINGLE CIRCUIT

Through the instruments keyboard is possible to completely disable a single circuit for maintenance or to use just a cooling part of of the unit.

CrEn FUNCTION enables – disables a circuit from keyboard.

Label involved with CrEn function: **Cr1E = circuit 1, Cr2E = circuit 2**

DISABLE A CIRCUIT

Enter the function Menu

- Use **UP** or **DOWN** keys to select CrEn on the bottom display
- Push **SET** key: the bottom display = **Cr1E**, top display = **En**.
- Select the circuit 1 or 2 with UP or DOWN (Cr1E or Cr2E).
- Push **SET** key for 3 seconds when one of the two Cr1E, Cr2E label are displayed. The top display shows the **En** blinking label, use the UP or DOWN to change in **diS** (Disabled) or **En** (Enabled). then push SET key to confirm the new selection. The display shows next circuit status.
- To exit the CrEn function push MENU key or wait the timeout.

17.8 READ-OUT OF A CIRCUIT NOT ENABLED

If one circuit is disabled the bottom display shows diS alternated with the label name of the measurement selected.

Circuit 1 = diS the bottom display shows **b1dS** = circuit 1 disabled.

Circuit 2 = diS the bottom display shows **b2dS** = circuit 2 disabled.

The **b2dS** label appears only if the 2nd circuit is configured,

17.9 ENABLE OR DISABLE A SINGLE COMPRESSOR

Through the instruments keyboard is possible to disable a single compressor for maintenance or to lock it when malfunctioning .

COEn FUNCTION compressors running status.

Label involved in COEn function: **CO1E = Compressor 1 status... CO6E = Compressor 6 status**

The COEn function uses only the compressors configured by the corresponding output parameters.

Enter the function Menu

- Use the **UP** or **DOWN** keys to select COEn.
- Push SET key: bottom display = CO1E, top display = En
- Select the compressor with UP or DOWN: CO2E - CO3E - CO4E - CO5E - CO6E if available.

4. Push SET for 3 seconds when the label corresponds to the compressor to disable: CO1E - CO2E - CO3E - CO4E - CO5E - CO6E. The top display shows the blinking En label, use the UP or DOWN key and change to diS (Compressor disabled) or En (compressor enabled) then push SET to confirm, the display shows next item.
5. To exit the COEn function push MENU key or wait the timeout.

17.10 READ-OUT OF A COMPRESSOR NOT ENABLED

During the normal running condition a disabled compressor is displayed with a blinking label alternated with the measurement value of the display.

If the compressor is disabled these the corresponding labels: C1dS = compressor 1 disabled...C6dS = compressor 6 disabled
The label C1dS...C6dS are available only if the corresponding compressor is configured.

17.11 READ-OUT OF THE COMPRESSOR DISCHARGE TEMPERATURE PROBE

The menu function allows to read-out the compressor temperature probes.

COdt FUNCTION shows the discharge temperatures

Label involved in **COdt** function: **CO1t** Compressor 1 discharge temperature... **CO6t** Compressor 6 discharge temperature

1. Use the UP or DOWN keys to select **COdt**
2. Push SET key: bottom display = **CO1t**, top display = temperature value of that probe.
3. Use the UP or DOWN keys to scroll the list: **CO1t** or **CO2t** or **CO3t** or **CO4t** or **CO5t** or **CO6t**
4. To exit the COEn function push MENU key or wait the timeout

ATTENZIONE

The labels **COdt** are available only if the corresponding compressor probe is configured.

The display resolution is 0.1°C until the read-out is 99.9, over 100°C it is 1°C.

17.12 READ-OUT OF THE RUNNING HOURS

This menu allows to shows all the time running hours of the compressors, supply fan and pumps.

Hour FUNCTION to show the controlled load consumption

Label involved in the Hour function:

CO1H Compressor 1 running hours .. **CO6H** Compressor 6 running hours.

EP1H Evaporator water pump or Supply fan running hours (air/air)

EP2H Support evaporator water pump running hours

CP1H Condenser water pump running hours

CP2H Support condenser water pump running hours

The labels are displayed only if the corresponding output is present and configured.

The running hours is displayed on the top display, the resolution is x 10 hours (eg 2 means 20 hours, 20 means 200hours)

Enter the function Menu

1. Use the UP or DOWN keys to select **Hour**
2. Push SET key: bottom display = above labels, top display = hours x10. The time  is on.
3. Use the UP or DOWN keys to scroll the list.
4. To exit the Hour function push MENU key or wait the timeout

17.13 RESET THE RUNNING HOUR

Enter the function Menu

1. Within the Hour function select, with UP or DOWN, the interested label: CO1H, CO2H, CO3H, CO4H, CO6H, EP1H, EP2H, CP1H, CP2H.
2. Push the **SET** keys for 3seconds: the top display shows the running hours blinking value, then it shows 0 to confirm the reset.
The next load label is automatically loaded.

To exit the Hour function push MENU key or wait the timeout

17.14 READ-OUT OF THE COMPRESSOR STARTS-UP

For each compressor is possible to show the number of starts-up.

COSn FUNCTION: number of starts-up of the compressor

Label involved in COSn function: **C1S** number of compressor 1 starts-up .. **C6S** number of compressor 6 starts-up

The labels are displayed only if the corresponding output is present and configured

The number of starts-up is displayed on the top display, the resolution is x 10 (eg 2 means 20 starts, 20 means 200starts)

Enter the function Menu

1. Use the UP or DOWN keys to select **COSn**.
2. Push **SET** one time: the label of the first load C1S is showed on the top display, the bottom display shows the number x10.
3. With UP or DOWN scroll the compressor list.
4. To exit the Hour function push MENU key or wait the timeout

17.15 RESET THE STARTS-UP NUMBER

Enter the function Menu

1. Within the Hour function select, with UP or DOWN, the interested label: CS1, CS2, CS3, CS4, CS6.
2. Push the **SET** keys for 3seconds: the top display shows the running hours blinking value, then it shows 0 to confirm the reset.
The next load label is automatically loaded.
3. To exit the Hour function push MENU key or wait the timeout.

17.16 READ-OUT OF THE PROPORTIONAL OUTPUT PERCENTAGE OF THE CONDENSER FAN CONTROL

The proportional outputs of the two circuits, that control the fan speed, can be showed in the menu function.

Cond FUNCTION selects the proportional output 1 and 2.

Label involved in Cond function:

Cnd1 Proportional output status of the condenser fan of the circuit 1.

Cnd2 Proportional output status of the condenser fan of the circuit 2.

TO SEE THE OUTPUT PERCENTAGE:

Enter the function menu

1. Use the UP or DOWN keys to select **Cond**.
2. Push **SET** key: the bottom display shows Cnd1, the top display shows the output percentage.
3. Use the UP or DOWN keys to select Cnd1 or Cnd2, the top display always shows the value, between 0% and 100%, of the proportional output of the selected circuit.
4. To exit the Hour function push MENU key or wait the timeout.

17.17 READ-OUT OF THE FOUR PROPORTIONAL OUTPUT

The four proportional outputs, 4..20ma or 0-10V, can be showed in the menu function.

Pout FUNCTION selects the proportional outputs.

Label involved in Cond function:

Pou1 Proportional output for dumper control or to drive the external relay 1

Pou2 Proportional output for dumper control or to drive the external relay 2

Pou3 Proportional output for dumper control or to drive the external relay 3

Pou4 Proportional output for dumper control or to drive the external relay 4

The labels are displayed only if the corresponding output is present and configured.

TO SEE THE FOUR OUTPUT PERCENTAGE:

Enter the function menu

1. Use the UP or DOWN keys to select **Pout**.
2. Push **SET** key: the bottom display shows Pou1, the top display shows the output percentage.
3. Use the UP or DOWN keys to select Pou1, Pou2, Pou3 or Pou4 the top display always shows the value, between 0% and 100%, of the proportional output of the selected circuit.
4. To exit the Hour function push MENU key or wait the timeout.

ATTENTION:

If the proportional output **Pou1 - Pou2 - Pou3 - Pou4** are configured to drive an external relay the display will show 0=relay off and 100=relay on.

17.18 READ-OUT OF THE TIME COUNTING TO THE NEXT DEFROST

The 2 times delay to next defrosts of the two circuits can be showed in the menu function.

dF FUNCTION time to next defrost.

Label involved in dF function:

dF1 delay time to next defrost of the circuit 1

dF2 delay time to next defrost of the circuit 2

The labels appear as on if the heat pump configuration is enabled.

Enter the function menu :

1. Use the UP or DOWN keys to select **dF**
2. Push **SET** key: the dF1 label is showed on the top display, the bottom display shows the time delay to next defrost in minutes / seconds. The  icon is on.
3. Use the UP or DOWN keys to select dF1 or dF2.
4. To exit the Hour function push MENU key or wait the timeout.

17.19 READ-OUT OF THE PROBES CONFIGURED TO CONTROL AN AUXILIARY OUTPUT RELAY

The probe values, configured to control the auxiliary relay output, can be showed in the menu function.

uS FUNCTION temperature/pressure value of the control probe for auxiliary output.

Label involved in uS function:

uSt1 auxiliary probe value of the circuit 1

uSt2 auxiliary probe value of the circuit 2

Enter the function menu

1. Use the UP or DOWN keys to select uS.
2. Push **SET** key: the label **uSt1** (temperature probe) or **uSP1** (Pressure probe) is showed on bottom display, the top display shows the the temperature or pressure value.
3. Use the UP or DOWN keys to select **uSt1** auxiliary probe for circuit 1 or **uSt2** auxiliary probe for circuit 2.
4. To exit the Hour function push MENU key or wait the timeout.

17.20 HOW TO DISPLAY THE TEMPERATURE OF THE INTERNAL TEMPERATURE SENSOR OF THE REMOTE TERMINALS 1 OR 2

Inside the function menu it is possible to see the ambient temperature detected by the NTC sensor

FUNCTION trEM to show the temperature of the remote panels
Identification label **trEM**.

trE1 value of the NTC probe of the remote #1

trE2 value of the NTC probe of the remote #2

Select with **UP** or **DOWN** the **trEM** function

Push **SET** the trE1 or trE2 label is shown on the bottom display, the top display shows the probe value.

Use the UP or DOWN arrow to change between **trE1** or **trE2** read-out.

To exit to the normal display read-out push MENU or wait the time – out time.

ATTENTION:

THE trEm function and the labels trE1 or trE2 appear only if the CF74 = =2 or 3 (remote panel 1 configuration) or if the parameter CF75 = 2 or 3 (remote panel 2 configuration).

18 ENERGY SAVING

18.1 ENERGY SAVING FROM DIGITAL INPUT

The energy saving is activated when one of the digital input configured as energy saving is ACTIVE.

The energy saving activation is signalled by the SET key led on. When working in Chiller or HP the first pressure on SET key shows the actual setpoint SetC (chiller) or SetH (HP) labels while the top display shows the set value.

If the energy saving is active the next pressure on the SET key shows the label “**SEtr**” (real setpoint), and the top display shows the real set value active in that moment.

During the Energy Saving cycle the setpoint is incremented with these parameter values ES14 / ES16: SET + ES14 for Chiller mode and SET + ES16 for HP mode.

The differential values, during the energy saving thermoregulation, are defined with parameter ES15 for chiller mode and ES17 and HP mode.

18.2 ENERGY SAVING TIME TABLE WITH RTC

The Energy Saving function with a daily RTC time table is available only if the RTC circuit (optional) is on board.

This function allows to set three start and stop energy saving daily periods (ES1..ES2, ES3..ES4, ES5..ES6).

The energy saving activation is signalled by the SET key led on. When working in Chiller or HP the first pressure on SET key shows the actual setpoint **SetC** (chiller) or **SetH** (HP) labels while the top display shows the set value.

If the energy saving is active the next pressure on the SET key shows the label “**SEtr**” (real setpoint), and the top display shows the real set value active in that moment.

During the Energy Saving cycle the setpoint is incremented with these parameter values ES14 / ES16: SET + ES14 for Chiller mode and SET + ES16 for HP mode.

The differential values, during the energy saving thermoregulation, are defined with parameter ES15 for chiller mode and ES17 and HP mode.

The function can work if the following requirements are satisfied:

1. RTC circuit mounted.
2. Parameters ES01...ES06 are not equal to 0 and are not programmed with the same value.

18.3 RTC DAILY TIME TABLE PROGRAMMING

This function can be also used to turn ON or OFF the unit.

Enter parameter programming:

1. Select with **UP** or **DOWN** keys the ES parameter family.
2. Within the ES parameters select with UP or DOWN keys the parameters ES01...ES06 to determine the start and stop of the energy saving daily periods.

Example

Set the energy saving start with ES01 and the energy saving stop time ES02 of the first period:

If **ES01 = 8.0 ES02 = 10.0** the energy saving setpoint is active from 8 to 10.

If **ES01 = 23.0 ES02 = 8.0** the energy saving setpoint is active from 23 (11pm) to 8 (8 am) in the morning of the next day.

If necessary repeat the operation for the others two time periods defined by ES03...ES04 and ES05...ES06.

18.4 ENERGY SAVING OR UNIT ON/OFF ACTIVATION WITH RTC PROGRAMMING

Enter the parameter programming:

1. Select with **UP** or **DOWN** keys the ES parameter family.
2. Within the ES parameters select with UP or DOWN keys the parameters ES07 (Monday)...ES13 (Sunday) to determine which days to include.

Configuration table Energy saving or unit ON/OFF activation with rtc programming

Par. ES07 – ES13	0= RTC not enabled 1= 1 st period enabled 2= 2 nd period enabled 3= 1 st and 2 nd periods enabled 4= 3 rd period enabled 5= 1 st and 3 rd periods enabled 6= 2 nd and 3 rd periods enabled 7= 1 st , 2 nd and 3 rd periods enabled
------------------	---

Energy saving or unit ON/OFF with RTC and X Y	where: X with range 0..7 represents the energy saving where: Y with range 0..7 represents the unit on/off
--	--

Example of a daily programming:

Monday

Enater parameter programming

1. In the ES parameter family, select the parameter ES07, the top display shows 0 - 0
2. Push SET key: the top display shows 0 - 0 blinking, with UP or DOWN keys select the corresponding function (see next table)
3. Push SET to confirm.
4. Push SET + UP to exit the programming or wait the programming timeout.

MONDAY X = 0 - Y= 0: The energy saving and the unit on/off are both disabled:

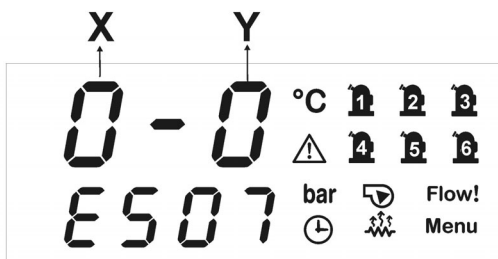

MONDAY X = 0 - Y= 1 energy saving is disabled, and unit on/off will follow the first RTC period ES1..ES2.

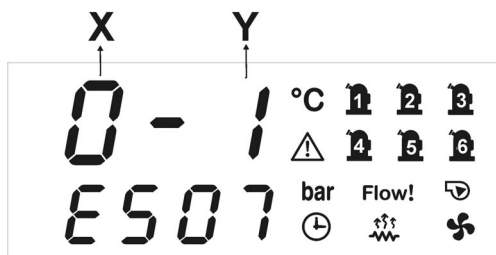

MONDAY X = 3 - Y= 7: energy saving enabled during the 1st and 2nd RTC periods, unit on/off enabled during the 1st, 2nd 3rd periods.

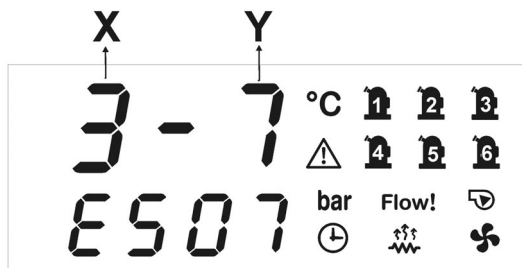

WEEKLY PROGRAMMING

Repeat the daily programming for the other days of the week using parameters ES08..ES13.

19 DYNAMIC SETPOINT

The dynamic setpoint allows to increase or decrease the setpoint with a proportional value determined by Sd01 (chiller) and Sd02 (HP) that depends from the 4..20mA analogue input or from the external air temperature probe. This function allows to save energy or run the unit when the external ambient is not within the normal operative conditions.

The dynamic setpoint activation is signalled by the SET key led on. When working in Chiller or HP the first pressure on SET key shows the actual setpoint **SetC** (chiller) or **SetH** (HP) labels while the top display shows the set value. If the energy saving is active the next pressure on the SET key shows the label **"SEtr"** (real setpoint), and the top display shows the real set value active in that moment.

The regulation is enabled if:

- In chiller mode the parameter Sd01 is not equal to 0.
- In heat pump mode the parameter Sd02 is not equal to 0.
- a 4÷20mA analogue input is configured as dynamic setpoint control or a NTC analogue input is configured as external air temperature for dynamic setpoint control.

With UP or DOWN keys within the circuit measurement read-out is possible to show the external air temperature indicated by the Et label.

19.1 DYNAMIC SETPOINT GRAPH

4÷20ma probe configured as dynamic setpoint analogue input:

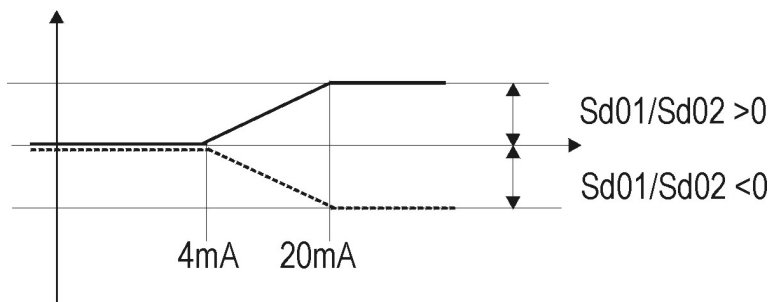

NTC probe with positive differential:

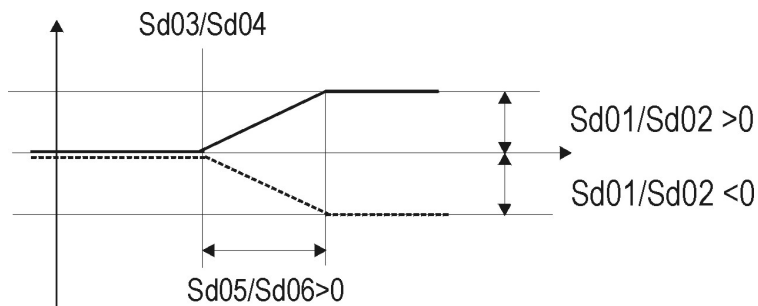

NTC probe with negative differential:

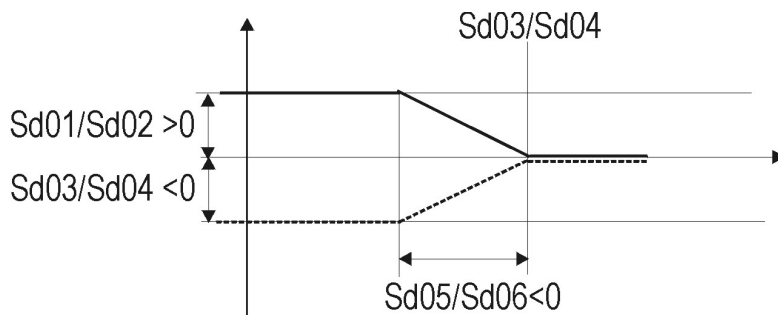

20 AUXILIARY RELAYS

The auxiliary relays can be configured to manage two independent, from heat pump or chiller mode, output controls. Each output can be managed with a dedicated temperature or pressure probe input (NTC probe, 4..20mA or 0..5V transducers) or with the common available temperature or pressure configurable inputs. The probe selection is made with parameters uS02 for the circuit 1 and uS06 for the circuit 2. The function is enabled when the parameter uS01 <>0 for the circuit 1 and the parameter uS05<>0 for the circuit 2 and at least one output is configured as auxiliary output. Par. **uS01** configuration auxiliary relay 1. Par. **uS05** configuration auxiliary relay 2. Value and function
 0 = Not enabled
 1 = Function enabled, direct action, also during stand-by or remote off.
 2 = Function enabled, direct action, only with unit running.
 3 = Function enabled, inverse action, also during stand-by or remote off
 4 = Function enabled, inverse action, only with unit running.

20.1 AUXILIARY RELAY WITH DIRECT ACTION

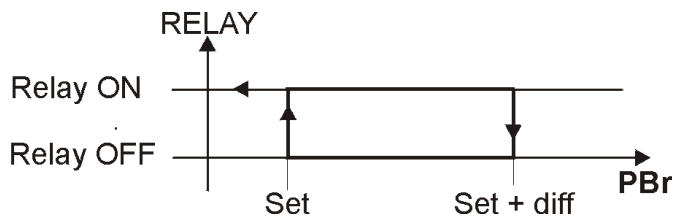

When:
 PBr < set : relay ON.
 PBr > set + differential: relay OFF.
 Set < PBr < set + differential: previous status.

PBr = NTC probe or transducer selected by the parameters uS02 / uS06

20.2 AUXILIARY RELAY WITH INVERSE ACTION

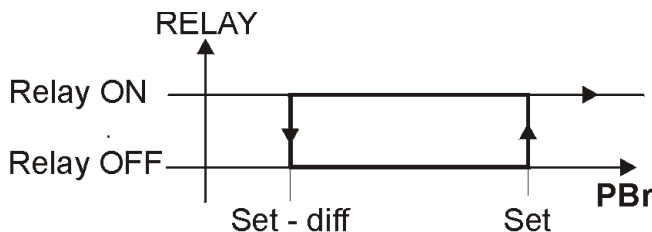

When:
 PBr > set : relay ON.
 Pbr < set - differential: relay OFF.
 Set - differential < PBr < set: previous status.
PBr = NTC probe or transducer selected by the parameters uS02 / uS06
 If:
 PBr > SET: relay ON
 Pbr < SET- differential: Relay OFF
 Set - differential < of PBr < SET: previous state

PBr = NTC probe or transducer selected with uS02 / uS06 parameters

21 COMPRESSOR THERMOREGULATION

21.1 THERMOREGULATION PARAMETER DESCRIPTION

Par. **ST01** Chiller Setpoint
 It allows to set the chiller working temperature within the range ST02..ST03.
 Par. **ST02** Minimum setpoint limit in chiller.
 The user can not program a setpoint value lower than ST02, the range is -30 °C..ST01.
 Par. **ST03** Maximum setpoint limit in chiller.
 The user can not program a setpoint value higher than ST02, the range is ST01..70°C.

Par. ST04 Heat pump setpoint

It allows to set the Heat pump working temperature within the range ST05..ST06.

Par. ST05 Minimum setpoint limit in heat pump.

The user can not program a setpoint value lower than ST05, the range is -30 °C..ST04.

Par. ST06 Maximum setpoint limit in heat pump

The user can not program a setpoint value higher than ST06, the range is ST01..70°C.

Par. ST07 Regulation band width in chiller mode.

The configured resources are distributed inside the regulation band.

Example Unit configured with 2 circuits, 3 compressors per circuit and thermoregulation controlled by the evaporator inlet NTC probe. Chiller setpoint: evaporator inlet water = 12°C, evaporator outlet water 7°C: when the evaporator inlet water is 12°C all the compressor outputs are on while when the evaporator inlet water is 7 °C all the compressors are OFF.

Thermoregulation parameters: Par. ST01 = 7 °C / Par. ST07 = 5 °C

Functioning: the regulation band ST07= 5 °C is divided by the number of resources 6 compressors therefore the step for each resource is 0.8°C, each 0.8°C if the temperature is increasing or decreasing one of the resource is turned on or off.

Par. ST08 Regulation band in heat pump mode

The configured resources are distributed inside the regulation band.

Example Unit configured with 2 circuits, 3 compressors per circuit and thermoregulation controlled by the evaporator outlet NTC probe. Chiller setpoint: evaporator inlet water = 40°C, evaporator outlet water 45°C: when the evaporator outlet water is 40°C all the compressor outputs are on while when the evaporator outlet water is 45 °C all the compressors are OFF.

Thermoregulation parameters: Par. ST04 = 40 °C / Par. ST08 = 5 °C

Functioning: the regulation band ST08=5 °C is divided by the number of resources 6 compressors therefore the step for each resource is 0.8°C, each 0.8°C if the temperature is increasing or decreasing one of the resource is turned on or off.

Par. ST08 Regulation band in heat pump mode

The configured resources are distributed inside the regulation band.

Par. ST09 Defines the thermoregulation probe in chiller.

- 0= NTC Temperature probe of the evaporator inlet
- 1= NTC Temperature probe of the evaporator circuit #1
- 2= NTC Temperature probe of the evaporator circuit #2
- 3= NTC Temperature probe of the common evaporator
- 4= Probe temperature of the remote front panel #1.
- 5= Probe temperature of the remote front panel #2.

The **ST10** parameter defines the thermoregulation probe of the unit with heat pump control

- 0= NTC probe temperature of the evaporator inlet
- 1= NTC probe temperature of the evaporator #1 outlet
- 2= NTC probe temperature of the evaporator #2 outlet
- 3= NTC probe temperature of the evaporator common outlet
- 4= Remote terminal # 1 probe
- 5= Remote terminal # 1 probe
- 6= NTC probe temperature of the condenser common inlet
- 7= NTC probe temperature of the condenser # 1 inlet
- 8= NTC probe temperature of the condenser # 2 inlet
- 9= NTC probe temperature of the condenser # 1 outlet
- 10= NTC probe temperature of the condenser # 2 outlet
- 11= NTC probe temperature of the condenser common outlet

ATTENTION

To have the same regulation both for chiller and heat pump set the parameters ST09 and ST10 with the same value

22 SELECTION OF THE KIND OF THERMOREGULATION

Par. ST11 determines the type of regulation

- 0= Proportional
- 1= Neutral zone
- 2= Proportional integral

22.1 GRAPH OF THE COMPRESSOR THERMOREGULATION IN CHILLER

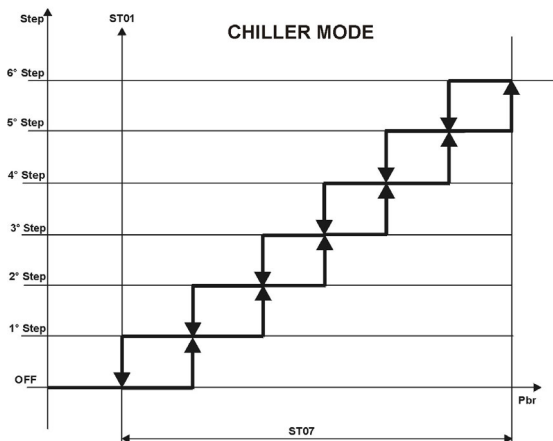

22.2 GRAPH OF THE COMPRESSOR THERMOREGULATION IN HEAT PUMP

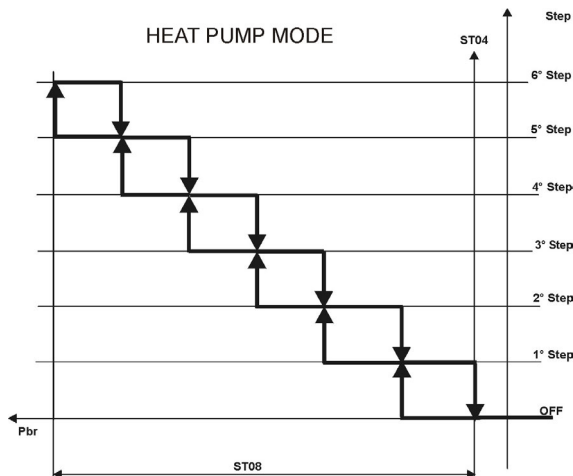

22.3 GRAPH NEUTRAL ZONE COMPRESSOR CONTROL

Not yet available on this version

Compressor regulation in chiller

Compressor regulation in heat pump

22.4 GRAPH PROPORTIONAL INTEGRAL COMPRESSOR REGULATION CONTROL

Not yet available on this version

Compressor regulation in chiller

Compressor regulation in heat pump

23 THERMOREGULATION OF THE ANTI FREEZE, INTEGRATION HEATING OR BOILER

23.1 THERMOREGULATION OF THE HEATERS IN CHILLER

The **Par. Ar06** selects the probe/s control for the anti-freeze alarm and the relay outputs configured as anti-freeze / support / boiler heaters for the circuits 1 and 2 in chiller mode.

Par. Ar06 = 0: the function is disabled

Par. Ar06 = 1: the thermoregulation, the anti-freeze alarm and the relay outputs for heaters circuit 1 and 2 (or both together) is controlled only throughout the NTC probe configured as evaporator water inlet.

Par. Ar06 = 2: the thermoregulation, the anti-freeze alarm and the relay outputs for heaters circuit #1 is controlled with NTC probe configured as evaporator probe outlet of the circuit #1.

The thermoregulation, the anti-freeze alarm and the relay outputs for heaters circuit #2 is controlled with NTC probe configured as evaporator probe outlet of the circuit #2.

ATTENTION: It is not possible to control the heaters of the crcuit #1 with the probe of the circuit #2 and viceversa.

Par. Ar06 = 3: the thermoregulation, the anti-freeze alarm and the relay outputs for heaters circuit 1 and 2 (or both together) is controlled throughout the NTC probe configured as evaporator water outlet circuit #1 or circuit #2 or evaporator water common outlet, or if they are all configured, by the first probe that goes below the setpoint.

23.2 THERMOREGULATION OF THE HEATERS IN HEAT PUMP

The **Par. Ar07** selects the probe/s control for the anti-freeze alarm and the relay outputs configured as anti-freeze / support / boiler heaters for the circuits 1 and 2 in heat pump mode.

Par. Ar07 = 0: the function is disabled

Par. Ar07 = 1: the thermoregulation, the anti-freeze alarm and the relay outputs for heaters circuit 1 and 2 (or both together) is controlled only throughout the NTC probe configured as evaporator water inlet.

Par. Ar07 = 2: the thermoregulation, the anti-freeze alarm and the relay outputs for heaters circuit #1 is controlled with NTC probe configured as evaporator probe outlet of the circuit #1.

The thermoregulation, the anti-freeze alarm and the relay outputs for heaters circuit #2 is controlled with NTC probe configured as evaporator probe outlet of the circuit #2.

ATTENTION: It is not possible to control the heaters of the circuit #1 with the probe of the circuit #2 and viceversa.

Par. **Ar07 = 3:** the thermoregulation, the anti-freeze alarm and the relay outputs for heaters circuit 1 and 2 is controlled throughout the NTC probes configured as evaporator water outlet circuit #1, circuit #2 and evaporator water common outlet, or if they are all configured, by the first probe that goes below the setpoint.

ATTENTION

The two outputs are controlled in parallel if configured with only by one NTC probe control for common evaporator outlet.

FUNCTIONNING OF THE ANTI-FREEZE, INTEGRATION HEATING, BOILER HEATERS DURING THE DEFROST CYCLE

The Ar05 defines the support heaters:

Par. **Ar05 = 0:** The heaters are activated only by the thermoregulation algorithm.

Par. **Ar05 = 1:** The heaters are activated only by the thermoregulation algorithm and are always on during the defrost. They turn on when the 4-way valve change from heat-pump to chiller and turn off only after the dripping time and the compressors restart.

23.3 THERMOREGULATION OF THE SUPPORT HEATERS FOR AIR/AIR UNIT

The NTC control in chiller mode depends on the Ar06 parameter value while from the Ar07 value in heat pump mode. With one relay configured as heaters for circuit #1

With one output configured as heater of the circuit #1 the output is enabled both for chiller and heat pump request.

With two outputs configured as heater of the circuit #1 and two the outputs are enabled both for chiller and heat pump request.

FUNCTIONNING OF THE SUPPORT HEATERS DURING THE DEFROST CYCLE

The Ar05 parameter defines the support heaters operating mode during the defrost.

Par. **Ar05 = 0:** the heaters are controlled only through the thermoregulation algorithm.

Par. **Ar05 = 1:** heaters are controlled only through the thermoregulation algorithm and are always on during the defrost cycle. They turn on when the 4-way valve change from heat-pump to chiller and turn off only after the dripping time and the compressors restart

ATTENTION

The support heaters are always off when:

- The supply fan is not configured
- The supply fan is off
- The unit is in stand-by or remote off
- The probe is faulty

23.4 CONDENSER ANTI-FREEZE HEATERS REGULATION

The regulation depends on the configuration of the heater circuit #1 relay and heater circuit #2 relay and the corresponding NTC probes used to this control.

The parameter Ar08 is used to select the heaters probe control both for chiller and heat pump.

Par. **Ar08 = 0:** The thermoregulation, the alarm and the heater regulation are disabled.

Par. **Ar08 = 1:** The thermoregulation, the alarm and the regulation of both the heaters together of the circuit 1 and 2 is executed **only** through the condenser water inlet NTC probe.

Par. **Ar08 = 2:** The thermoregulation, the alarm and the heater #1 regulation is executed through the condenser water outlet NTC probe of the circuit #1.

The thermoregulation, the alarm and the heater #1 regulation is executed through the condenser water outlet NTC probe of the circuit #2.

ATTENTION

It is not possible to control the heaters of the circuit #1 with the NTC probe of the condenser water outlet of the circuit #2 and viceversa.

Par. **Ar08 = 3**

The thermoregulation, the alarm and the regulation of both the heaters together of the circuit 1 and 2 is executed through the probes configured as condenser water outlet of the circuit #1 and 2 and the NTC of the common outlet.

ATTENTION

When the outputs are configured as heaters circuit #1 and 2 they are both controlled by the NTC probe of the common condenser outlet.

23.5 THE THERMOREGULATION OF THE ANTI-FREEZE HEATERS OF THE CONDENSER/RECOVERY

The thermoregulation depends on the configuration of the circuit #1 and 2 heaters and the NTC probe to control the cycle.

The Par. Ar08 selects the probe to control the anti-freeze alarm and the heaters thermoregulation.

Par. **Ar08 = 0:** the thermoregulation, the anti-freeze alarm and the heaters control of the circuit #1 is controlled by the NTC of the condenser water common inlet or the circuit #1, while the relay output for circuit #2 is controlled through the NTC configured as condenser water common inlet or circuit 2.

Par. **Ar08 = 1:** the thermoregulation, the anti-freeze alarm and the heaters control of the circuit #1 is controlled by the NTC of the condenser water common outlet or the circuit #1, while the relay output for circuit #2 is controlled through the NTC configured as condenser water common outlet or circuit 2.

23.6 GRAPH OF THE ANTI-FREEZE- INTEGRATION HEATING - BOILER HEATER RELAYS

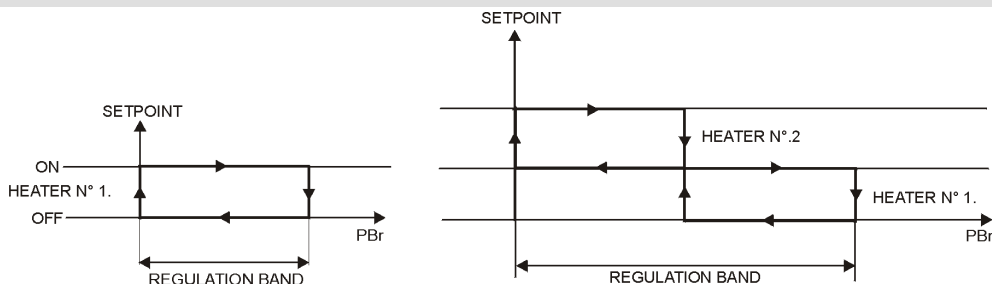

23.7 BOILER THERMOREGULATION(ANTIFREEZE), BOILER FUNCTION

To determine the electrical heater control in chiller or heat pump mode because the electrical heaters can be used as anti-freeze or can also be used to integrate or heating the heat pump mode or in particular situation in chiller mode.

The function is enabled when:

1. One NTC probe configured as external air for dynamic setpoint / boiler function.
2. Parameter Ar11 <>0.

Integration control Ar11=1

When the air temperature value detected by the external air probe decreases under the Ar12 setpoint, the Ar14 delay starts counting. If during the Ar14 counting the external air increases above the Ar12 + Ar13 (differential) the function is aborted and the Ar14 time is reloaded.

When the time Ar14 is expired and the external air temperature is still under the Ar12 setpoint and the water temperature detected by the evaporator probe is lower than Ar15 in chiller mode or Ar17 in heat pump mode, the heaters are turned on. When the temperature rises over Ar15 + Ar16(differential) in chiller mode or Ar17+Ar18 in heat pump the heaters are turned off.

With the heaters on if the temperature of the external air rises above the Ar12 (set) + Ar13(differential) immediately they are turned off and the Ar14 delay is reloaded.

Attention With Boiler function activated and external air temperature value lower than Ar12 if the air temperature decreases under the Ar19 setpoint the compressors are turned off. They are restarted only if the external air temperature rises above Ar19+Ar20 (differential).

Heating control Ar11=2

If during the functioning the external air temperature value goes down under the Ar12 setpoint, the Ar14 delay time starts counting. If during this delay the external temperature rises above the Ar12+Ar13 the process is aborted and the time Ar14 reloaded.

If after the Ar14 delay the external air temperature is still under the Ar12 setpoint and the regulation water temperature detected by the evaporator probe is lower than Ar15 (chiller) or Ar17 (Heat Pump), the heaters are turned on while the compressor(s) and the condensing fan(s) are turned off. The heating is made only by the heaters.

When the temperature rises above the Ar15+Ar16(regulation band in chiller) or Ar15 + Ar17(regulation band in HP) the heaters are turned off.

If during the functioning the external air temperature value rises above the Ar12 +Ar13, the heaters are turned off and the compressor thermoregulation is restarted, the Ar14 delay is reloaded.

HEATERS of the BOILER (ANTI-FREEZE) DURING the DEFROST CYCLE

The Ar05 parameters defines the functioning of the heaters of the boiler during the defrost, If Ar05=0 the heaters are activated by the thermoregulation while if Ar05=1 the heaters are turned on when the 4-way valve changes the status from heat pump to chiller and then they are turned off after the dripping time at the end of the defrost.

ATTENTION

The heaters of the boiler are always off when:

- Active flow alarm
- Active overload alarm of the configured water pump
- Active overload alarm of one of the two water pumps configured and any of the water pumps available for the water flow control.

(In this case the heaters are activated only by the anti-freeze setpoint to protect the evaporator)

24 ANTI - FREEZE ALARM AND HEATERS REGULATION THROUGH DIGITAL INPUT

The anti-freeze alarm and the heaters regulation of the 1st circuit is managed by the digital input configured as anti-freeze alarm circuit #1.

The anti-freeze alarm and the heaters regulation of the 2nd circuit is managed by the digital input configured as anti-freeze alarm circuit #2.

ATTENTION

The output of the 1st circuit can not be managed by the digital input of the 2nd circuit and viceversa.

The regulation outputs of th1 1st and 2nd circuit can be regulated together by a single digital input configured as anti-freeze circuit #1 or circui #2. In this case, with active alarm of the common digital input, the display will show both the antifreeze alarm messages.

25 THERMOREGULATION AND COMPRESSORS ROTATION

The **CO14** parameter determines the compressor on and off sequence.

CO14= 0

Sequential. Depending on the thermoregulation: the 1st compressor is turned on, then the 2nd and the 3rd etc.; then the 3rd off, the 2nd and then 1st. The first is off only if the 2nd and 3rd are off.

CO14= 1

Rotation by hour. Depending on the time running hours the first compressor called by the thermoregulation is the one with less time running hours. This algorithm is aborted if the unit is configured with one capacity compressor.

CO14= 2

Rotation by starts-up. Depending on the number of starts-up per hour the first compressor called or turned off is the one with less starts-up number. This algorithm is aborted if the unit is configured with one capacity compressor.

26 SATURATION - CIRCUIT BALANCING

CIRCUIT SATURATION

CO15 = 0

Depending on the thermoregulation all the compressors of the first are turned on before using the second circuit.

Eg. 2 circuits, 2 step for each circuit (total of 4 resources)

Activation:

The thermoregulation immediately requires all the 4 resources: the controller turns on the compressor with less running hours, then the second compressor of the same circuit. Then it is turned on the compressor with less running hours of the other circuit and then the second compressor of the other circuit.

De-activation:

It is selected first the the circuit having less resources on, if the running resources are equals for both circuits, the first compressor turned off is the one with the greater number of running hours or less number of starts-up, then, in the same circuit, the other resources are turned off. With the same algorithm the controller will turn off the resources of the other circuit.

CIRCUIT BALANCING

CO15 = 1: the circuit balancing is applicable only if there a2 circuits and 2 resources for circuits (total of 4 resources).

The circuit balancing allow to equalise the power supplied by the two circuits, the difference can be one step maximum.

ES. 2 circuits, 2 step for each circuit (total of 4 resources)

Activation:

The thermoregulation immediately requires all the 4 resources: the controller turns on the compressor with less running hours, then the compressor with less running hours of the other circuit. Again the first circuit and it is turned on the 2nd compressor then the second compressor of the other circuit.

De-activation:

It is selected first the circuit having more resources on, if the running resources are equals for both circuits, the first compressor turned off is the one with the greater number of running hours or less number of starts-up, then, in the other circuit, the other compressor with less running hours. Again the first circuit and it is turned off the 2nd compressor then the second compressor of the other circuit.

COMPRESSOR REGULATION

- When it is turned on each compressor runs for the CO01 minimum time. This minimum time is aborted in case of **alarm, STAND-BY / ON OFF by remote, defrost or partialization through NTC transducer.**
- When it is turned off each compressor can restart only after the CO02 time delay.
- Both for sequential or rotation regulation with compressors or capacity steps: the successive resource is turned on after the CO03 delay in seconds.
- Both for sequential or rotation regulation with compressors or capacity steps: the successive resource is turned off after the CO03 delay in seconds.
- If the power supply fails **all the outputs are forced off** for the CO005 time delay.

27 COMPRESSORS

27.1 COMPRESSORS START- UP

Parameter CO10 defines the compressor start-up:

CO10=0 (direct)

CO10=1(part winding)

CO10=2 (Star-delta)

To configure the compressor start-up it is necessary check the CF parameters of the relay outputs.

After selecting the compressor start-up mode, if the output resources are not properly configured, eg: more or less relay outputs than the necessary, the ACF6 alarm is displayed.

27.2 DIRECT START- UP

Configure one relay output for each compressor (K1 relay Fig. 1). One relay output controls the corresponding compressor up to 6 resources.

EXAMPLE

Direct start up configuration for one compressor

Set the Parameter CF54 = 21. Direct start-up RL1 compressor # 1

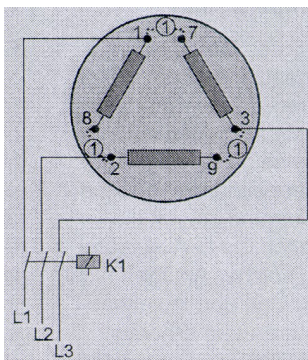

Fig. 1

27.3 DIRECT START- UP OF A CAPACITY COMPRESSOR

When working with capacity compressors and with full power start-up: the controller turns the solenoid valve on first and then, after 1 second, the compressor motor. During the CO13 time delay the valve is forced on: minimum power. When the CO13 is expired if the thermoregulation requires more power the valve will be switched off (maximum power).

27.4 PART WINDING

This algorithm allows to reduce the start-up current when using hermetic or semi-hermetic compressors or medium – big screw compressors.

Each compressor needs two relay outputs:
 One is the PW motor coil #1 of the compressor;
 One is the PW motor coil #2 of the compressor;
 The time delay between the two outputs is determined by CO11 expressed in decimal of second in a range 0..5 seconds.
 The maximum number of relay outputs is 8 this means 4 compressors with Part Winding start-up.

EXAMPLE

Part Winding configuration of the compressor relay outputs
 Set the Par CF54 = 21. PW motor coil #1 relay of the compressor #1;
 Set the Par CF55 = 22. PW motor coil #2 relay of the compressor #1;

27.5 COMPRESSOR START- UP WITH PART WINDING

First is turned on the PW motor coil #1 of the compressor #1 (relay K1 of fig2), after the CO11 delay it is turned on the second motor coil of the same compressor (relay K2 of fig2).
 To turn off the compressor the two relay outputs are both turned off at the same time.

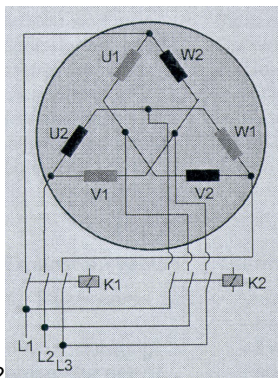

Fig 2

27.6 PART WINDING START- UP OF COMPRESSORS OR CAPACITY COMPRESSORS

If one or more capacity compressors are configured and the thermoregulation requires the full load start-up: the controller turns the solenoid valve on, after 1 second the first motor part of the 1st compressor (relay K1 of Fig. 2) and then the complete control with the contactor K2. During the CO13 time delay the step valve is forced on: minimum power. When the CO13 is expired if the thermoregulation requires more power the valve will be switched off (maximum power).

27.7 STAR - DELTA START

This algorithm allows to reduce the start-up current when using hermetic or semi-hermetic compressors or medium – big screw compressors.

Each compressor needs three relay outputs
 The maximum number of relay outputs is 6 this means 2 compressors with Star-delta start-up.

EXAMPLE

Star-delta configuration of the compressor relay outputs
 Set Par CF54 = 21. Star-delta line #1 relay of the compressor #1;
 Set Par CF55 = 22. Star-delta line #2 relay of the compressor #1;

Set Par CF56 = 23. Star-delta centre relay of the compressor #1;

27.8 STAR - DELTA START OF A COMPRESSOR

Each compressor needs three relay outputs:

One relay output as Line #1 of the compressor #1 (Relay K1 of the Fig.3).

One relay output as Line #2 of the compressor #1 (Relay K3 of the Fig.3).

One relay output as centre of the star (Relay K2 of the Fig.3)

To turn on the compressor: the centre of the star relay is turned on (Relay K2 of the Fig.3), after 1 second the Line #1 relay is turned on (relay K1 Fig.3). The two relays work together for the time set in CO11, then the relay of centre of the star is switched off (relay K2 Fig.2). Then after the CO12 delay time the relay of the line #2 is turned on (relay K3 Fig.3).

To turn off the compressor: The output relay of the line #1 and line #2 are switched off together.

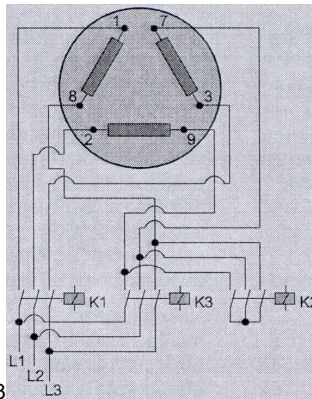

Fig. 3

27.9 STAR - DELTA START- UP OF A CAPACITY COMPRESSOR

If one or more capacity compressors are configured and the thermoregulation requires the full load control, the controller turns the solenoid valve on, then after 1 second the centre of the star relay is turned on (relay K2 Fig. 3). Then the star-delta procedure will be completed with the other two contactors. During the CO13 time delay the step valve is forced on: minimum power. When the CO13 is expired if the thermoregulation requires more power the valve will be switched off (maximum power).

28 CAPACITY CONTROL

CO06 capacity control operative mode.

The relay configured as capacity control are managed by the thermoregulation as shown in the graph and into the tables here below.

Par CO06 = 0 ON/OFF step

0= Step control. Depending on the thermoregulation requests and the output polarity a power step can be enabled or disabled. The step is activated only after the previous is turned off.

Eg: # 1 capacity compressor with 3 partializations: 4 Power steps.

Capacity	25%	50%	75%	100%
Compr.	Compressor ON	Compressor ON	Compressor ON	Compressor ON
Out relay	Step P 1 ON	Step P 1 OFF	Step P 1 OFF	Step P 1 OFF
Out relay	Step P 2 OFF	Step P 2 ON	Step P 2 OFF	Step P 2 OFF
Out relay	Step P 3 OFF	Step P 3 OFF	Step P 3 ON	Step P 3 OFF

Step control process

Compressor	Part #1	Part #2	Part #3

Power involved
0 %
25 %
50 %
75 %
100 %

Par CO06 = 1 direct action with sequential step

1= the steps are turned on in sequential mode, the outputs are anabled or disabled depending on the output polarity. In case of thermoregulation request one of the step is turned on or off while the other steps do not change their status.

Eg: # 1 capacity compressor with 3 partializations: 4 Power steps.

Capacity	25%	50%	75%	100%

Compr.	Compressor ON	Compressor ON	Compressor ON	Compressor ON
Out relay	Step P 1 ON	Step P 1 ON	Step P 1 ON	Step P 1 OFF
Out relay	Step P 2 OFF	Step P 2 ON	Step P 2 ON	Step P 2 OFF
Out relay	Step P 3 OFF	Step P 3 OFF	Step P 3 ON	Step P 3 OFF

Direct action with sequential step

Compressor	P1	P2	P3

Power involved
0 %
25 %
50 %
75 %
100 %

Par CO06 = 2 inverse action with sequential step

1= the steps are turned on in sequential mode, the outputs are enabled or disabled depending on the output polarity. In case of thermoregulation request one of the step is turned on or off while the other steps do not change their status.

Eg: # 1 capacity compressor with 3 partializations: 4 Power steps.

Capacity	25%	50%	75%	100%
Compr.	Compressor ON	Compressor ON	Compressor ON	Compressor ON
Out relay	Step P 1 ON	Step P 1 ON	Step P 1 ON	Step P 1 OFF
Out relay	Step P 2 ON	Step P 2 ON	Step P 2 OFF	Step P 2 OFF
Out relay	Step P 3 ON	Step P 3 OFF	Step P 3 OFF	Step P 3 OFF

Inverse action with sequential step

Compressor	P1	P2	P3

Power involved
0 %
25 %
50 %
75 %
100 %

Par CO06 = 3 Continuous with steps and direct total action

3 = the steps are turned on in sequential mode, the outputs are enabled or disabled depending on the output polarity. In case of thermoregulation request one of the step is turned on or off while the other steps do not change their status.

Eg: # 1 capacity compressor with 3 partializations: 4 Power steps.

Capacity	25%	50%	75%	100%
Compr.	compressor ON	compressor ON	compressor ON	compressor ON
Out relay	Step. N° 3 OFF	Step N° 3 OFF	Step. N° 3 OFF	Step. N° 3 ON
Out relay	Step N° 2 OFF	Step. N° 2 OFF	Step. N° 2 ON	Step. N° 2 ON
Out relay	Step. N° 1 OFF	Step N° 1 ON	Step N° 1 ON	Step N° 1 ON

Direct action with sequential step

Compressor	P1	P2	P3

Power involved
0 %
25 %
50 %
75 %
100 %

ATTENTION

When working with capacity control in sequential step in direct or reverse modes: if the power requested is 50% and 75% the unit turn on also the step 25% that must be enabled to make run the other two.

28.1 MINIMUM LOAD START- UP

Par. CO07 configuration of the start-up with minimum load and compressor type.

It allows to configure the 1st partialization valve of the compressor that can be the partialization start-up valve of an alternative compressor or the minimum load for screw compressor.

In this way the lower value of partialization (normally is configured as the 1st output with the 25%) can be used as minimum start-up load and also as thermoregulation step or only as minimum start-up load and never as thermoregulation step.

EXAMPLE

Having one compressor with 3 partializations, at the compressor start-up, with **CO07=0**, the partialization valve is enabled only for the time CO13 but it won't be never used during the thermoregulation. After the compressor stops running the time CO13 will be reloaded.

Having one compressor with 3 partializations, at the compressor start-up, with **CO07=1**, the partialization valve is enabled for the time CO13 and it will be considered also as thermoregulation step. After the compressor stops running the time CO13 will be reloaded.

EXAMPLE WITH SCREW COMPRESSOR

Having one compressor with 3 partializations, with **CO07=2** when the compressor is off the partialization valve is always on, so as, in case of start-up, it allows to have the minimum load. After the compressor is started the valve is on only for CO13 time and it won't be considered as regulation step. After the compressor stops running the time CO13 will be reloaded.

Having one compressor with 3 partializations, with **CO07=3** when the compressor is off the partialization valve is always on, so as, in case of start-up, it allows to have the minimum load. After the compressor is started the valve is on for CO13 time but it will be considered as regulation step. After the compressor stops running the time CO13 will be reloaded.

28.2 BY-PASS GAS VALVE DURING COMPRESSOR START-UP

It allows to manage, with the partialization valve, also the valve to run the compressor with no load by-passing the circuit.

On time of the by-pass gas valve during the compressor start-up.

The function is enabled if the CO13 <>0 and one of the relay output is configured as by-pass valve compressor 1, 2, 3 or 4.

Functioning: When thermoregulation requires the relay is turned ON 1 second before turning in the compressor and goes off after the time set in parameter CO13. After the compressor stops running the time CO13 will be reloaded.

28.3 SOLENOID VALVE INTERMITTENT FOR SCREW COMPRESSOR

If configured this output is ON when the compressor is ON (in case of Part Winding or Star-delta it corresponds with the first relay on) for the time set in Par. CO08 and then OFF for the time set in Par. CO09. The cycle CO08 – CO09 of the valve is repeated until the compressor is ON.

ATTENTION:

When the valve output is configured, the intermittent cycle is activated only if the Par. CO08 <> 0.

29 PUMP DOWN

The Pump down process is enabled only if the CO36 parameter is not equal to 0.

29.1 OFF UNIT WITH PUMP DOWN AND WITH LOW PRESSURE SWITCH CONTROL

The process is enabled if the low pressure switch of the circuit is configured with parameter CO36 = 1 or 3 and one of the relay output is configured as pump-down solenoid circuit 1 or 2. (CO36 = 2 or 4 are related to a pressure switch dedicated to this function or the pressure transducer).

When the thermoregulation is going to stop, before turning off the last compressor, the solenoid valve is closed. The compressor runs until the low pressure switch connected to the digital input becomes active for a maximum time set in CO39. In this case there is no Low pressure alarm and no alarm message will be displayed, the digital input active function will disable the last running compressor. A possible low pressure alarm could appear only if the digital input is still active after the AL02 time.

If the last compressor stops before the low pressure switch because of the CO39 time-out (maximum compressor on time after turning off the P.D. solenoid valve), the ICHILL calculates the AL21 parameter (maximum number of pump down alarm per hour) and if an alarm occurs the display will show the alarm code, the buzzer and the alarm relay will be on.

If the thermoregulation is stopped via digital input (as remote off) or from chiller/heat pump keys, during the pump down process the chiller or the heat pump led will blink.

When the next thermoregulation restarts the PD solenoid valve turns on and after 1 seconds, if the low pressure switch is not active, the compressors start.

For any compressor alarm events occur the procedure is stopped and the compressor will be stopped.

PAR. CO36 = 3 OFF UNIT WITH PUMP DOWN in CHILLER MODE (No PUMP – DOWN at START-UP)

In Heat pump mode the Pump down process is inhibited and the solenoid valve works in parallel with the compressor.

29.2 PUMP DOWN WITH DEDICATED PRESSURE SWITCH

PAR.CO36 = 1 OFF UNIT WITH PUMP DOWN (No PUMP – DOWN at START-UP)

The function is enabled if one relay output is configured as pump down solenoid valve for circuit 1 and 2 and one digital input as pump down pressure switch of the circuit 1 and 2.

When the thermoregulation is going to stop, before turning off the last compressor, the solenoid valve is closed. The compressor runs until the pump down pressure switch connected to the digital input becomes active for a maximum time set in CO39.

If the last compressor stops before the pump down pressure switch because of the CO39 time-out (maximum compressor on time after turning off the P.D. solenoid valve), the ICHILL calculates the AL21 parameter (maximum number of pump down alarm per hour) and if an alarm occurs the display will show the alarm code, the buzzer and the alarm relay will be on.

If the thermoregulation is stopped via digital input (as remote off) or from chiller/heat pump keys, during the pump down process the chiller or the heat pump led will blink.

When the next thermoregulation restarts the PD solenoid valve turns on and after 1 seconds, if the low pressure switch is not active, the compressors start.

For any compressor alarm events occur the procedure is stopped and the compressor will be stopped.

PAR. CO36 = 2 ON/OFF WITH PUMP DOWN

The function is enabled if one relay output is configured as pump down solenoid valve for circuit 1 and 2 and one digital input as pump down pressure switch of the circuit 1 and 2. (CO36 = 2 or 4 are related to a pressure switch dedicated to this function or the pressure transducer).

When the thermoregulation is going to stop, before turning off the last compressor, the solenoid valve is closed. The compressor runs until the pump down pressure switch connected to the digital input becomes active for a maximum time set in CO39.

If the last compressor stops before the pump down pressure switch because of the CO39 time-out (maximum compressor on time after turning off the P.D. solenoid valve), the ICHILL calculates the AL21 parameter (maximum number of pump down alarm per hour) and if an alarm occurs the display will show the alarm code, the buzzer and the alarm relay will be on.

If the thermoregulation is stopped via digital input (as remote off) or from chiller/heat pump keys, during the pump down process the chiller or the heat pump led will blink.

When the next thermoregulation restarts the PD solenoid valve turns on and after 1 seconds, if the low pressure switch is not active, the compressors start.

If the compressors do not restart within the CO39 time the pump-down alarm will signalled and the compressor are stopped. In this case if AL23 =0 the compressor can restart only if the pressure switch becomes active, or if AL23=1 and the number of alarms per hour becomes =AL22 only after the manual reset

PAR. CO36 = 3 OFF UNIT WITH PUMP DOWN in CHILLER MODE (No PUMP – DOWN at START-UP)

In Heat pump mode the Pump down process is inhibited and the solenoid valve works in parallel with the compressor.

PAR. CO36 = 4 ON and OFF UNIT WITH PUMP DOWN in CHILLER MODE

In Heat pump mode the Pump down process is inhibited and the solenoid valve works in parallel with the compressor.

29.3 PUMP DOWN FUNCTION WITH DEDICATED PRESSURE PROBE

PAR.CO36 = 1 STOP UNIT with PUMP DOWN (No PUMP – DOWN at START-UP)

The function is enabled if one relay output is configured as pump down solenoid valve for circuit 1 and 2 and one analogue input as low pressure probe of the circuit 1 and 2.

When the thermoregulation is going to stop, before turning off the last compressor, the solenoid valve is closed. The compressor runs until the pump down pressure connected to the analogue input reaches the set value in CO37.

If the last compressor stops before the pump down set value because of the CO39 time-out (maximum compressor on time after turning off the P.D. solenoid valve), the ICHILL calculates the AL21 parameter (maximum number of pump down alarm per hour) and if an alarm occurs the display will show the alarm code, the buzzer and the alarm relay will be on.

If the thermoregulation is stopped via digital input (as remote off) or from chiller/heat pump keys, during the pump down process the chiller or the heat pump led will blink.

When the next thermoregulation restarts the PD solenoid valve turns on and after 1 seconds, if the low pressure switch is not active, the compressors start.

For any compressor alarm events occur the procedure is stopped and the compressor will be stopped.

PAR. CO35 = 2 UNIT START/STOP with PUMP DOWN

The function is enabled if one relay output is configured as pump down solenoid valve for circuit 1 and 2 and one analogue input as low pressure probe of the circuit 1 and 2.

When the thermoregulation is going to stop, before turning off the last compressor, the solenoid valve is closed. The compressor runs until the pump down pressure probe connected to the analogue input reaches the setpoint in CO37.

If the last compressor stops before the pump down pressure switch because of the CO39 time-out (maximum compressor on time after turning off the P.D. solenoid valve), the ICHILL calculates the AL21 parameter (maximum number of pump down alarm per hour) and if an alarm occurs the display will show the alarm code, the buzzer and the alarm relay will be on.

If the thermoregulation is stopped via digital input (as remote off) or from chiller/heat pump keys, during the pump down process the chiller or the heat pump led will blink.

When the next thermoregulation restarts the PD solenoid valve turns on and after 1 seconds, if the pressure probe is higher then CO37, the compressors start.

If the compressors do not restart within the CO39 time the pump-down alarm will signalled and the compressor are stopped. In this case if AL23 =0 the compressor can restart only if the pressure switch becomes active, or if AL23=1 and the number of alarms per hour becomes =AL22 only after the manual reset.

PAR. CO36 = 3 START UNIT WITH PUMP DOWN in CHILLER MODE (No PUMP – DOWN at START-UP)

In Heat pump mode the Pump down process is inhibited and the solenoid valve works in parallel with the compressor.

PAR. CO36 = 4 UNIT START/STOP WITH PUMP DOWN in HEAT PUMP

In Heat pump mode the Pump down process is inhibited and the solenoid valve works in parallel with the compressor.

29.4 PUMP DOWN ALARM DURING COMPRESSORS START- UP

ACTIVATION

If within the CO39 delay time (Maximum pump down restart time) the compressor/s do not restart because of the low pressure, the instrument will signal B1PL (pump down alarm at the start-up of the circuit 1) or the label B2PL (pump down alarm at the start-up of the circuit 2). With active alarm the restart procedure is disabled. The alarms can be:

- with Automatic Reset that is not logged, the buzzer and alarm relay are not activated.
- with Manual Reset that is logged, the buzzer and alarm relay are activated.

The Parameter **AL22** determines the number of pump down alarm events to turn from automatic to manual reset

The Reset is always manual if AL22 = 0

The Reset is always automatic if AL22 = 16

The reset becomes manual after AL22 = 1 ..15 events and the configuration of Par. AL23.

Par. **AL23** defines if the reset of the AL22 alarm events can be forced from manual to automatic. In this case the alarm events, after reaching AL22, is automatically reset but it is logged while the buzzer and the alarm relay are on.

In this way, in case of particularly critical condition, the unit restarts working without the help of the maintenance personnel.

RESET

- The Automatic Reset is activated when the next compressor thermoregulation is requested, in this case the pressure condition of the pump down must be satisfied.
- The Manual Reset needs to enter the function Menu under the **AirM** label. After the reset the next thermoregulation restarts if the pump down pressure is in normal condition.

ATTENTION

If the pump down function is enabled, during the unit start-up from digital input as pump down pressure switch and also from analogue input as low pressure transducer, the compressor will restart only if both the inputs are satisfied.

29.5 PUMP DOWN ALARM DURING COMPRESSORS SWITCHING OFF**ACTIVATION**

If within the time delay CO39 (maximum pump down duration in off) the low pressure switch or the pump down pressure switch is not active or the pump down setpoint is not reached, the last compressor is switched off. In this case after this timeout the instrument signals the B1PH or 2 alarms, in both cases when active the compressor is stopped.

The alarm can be:

- with Automatic Reset that is not logged, the buzzer and alarm relay are not activated.
- with Manual Reset that is logged, the buzzer and alarm relay are activated.

The Parameter **AL21** determines the number of pump down alarm events to turn from automatic to manual reset

The Reset is always manual if AL21 = 0.

The Reset is always automatic if AL21 = 16.

The reset becomes manual after AL21 = 1 ..15.

RESET

- The Automatic Reset is activated when the next compressor thermoregulation is requested, in this case the pressure condition of the pump down must be satisfied.
- The Manual Reset needs to enter the function Menu under the **AirM** label. After the reset the next thermoregulation restarts if the pump down pressure is in normal condition.

ATTENTION

If the pump down function is enabled, during the unit start-up from digital input as pump down pressure switch and also from analogue input as low pressure transducer, the compressor will restart only if both the inputs are satisfied.

29.6 PUMP DOWN INFORMATION**ATTENTION**

SELECTION OF THE COMPRESSOR (for pump down in switching off)

Eg: Unit with 2 circuits and 3 compressors each.

Having an active digital input as remote off: if the compressor running hours are the same for all the compressors the unit will use the 1st compressor of the 1st and the 2nd circuit: therefore the number 1 and 4.

If the running hours are not equal for all compressors the unit will use the compressor having the less running time, this for any circuit configuration.

During the pump down process the led of the running mode (chiller / heat pump) is blinking, while if one of the circuits are disabled from the keyboard the running mode led is not blinking.

30 UNLOADING**30.1 HIGH TEMPERATURE OF THE EVAPORATOR WATER INLET**

The function is always enabled in chiller mode if there are at least 2 steps of power (two compressor or 1 compressor with partialization) per circuit.

It is used to run the unit with high temperature of the evaporator water inlet (such as during the hot summer) to avoid a possible high pressure alarm event.

The function is managed through an analogue input configured as NTC evaporator water inlet.

30.2 UNLOADING DESCRIPTION**UNLOADING ACTIVATION**

When the thermoregulation request begins to start the compressors in chiller mode, if the evaporator water inlet is equal or bigger than the CO40 setpoint for the CO42 time.

When the unloading is active the display shows the AEUn blinking message alternated with the selected display measurement, the unit will start with the loads selected with the CO49 parameter.

EXAMPLE

Unit with 2 circuits with 3 compressors each circuit.

If Par. CO49 = 2, 2 power steps per circuit, in case of unloading there will be 4 compressor running.

UNLOAD DEACTIVATION

If the temperature decreases under the value determined by (CO40-CO41) setpoint – differential, the unloading is disengaged, the compressors are all available for the thermoregulation.

30.3 UNLOADING INFORMATION

If the temperature does not decrease enough to reach the CO40-CO41 value, under the CO40 setpoint the CO43, unloading timeout, will start counting and when expired the unit will force the unloading off.

30.4 UNLOADING WITH PRESSURE, CONDENSING TEMPERATURE OR EVAPORATING PRESSURE CONTROL

The function is always enabled for both the running mode in order to reduce the load and helps the unit to start: in chiller for high temperature of the external air to avoid high pressure alarms, in heat pump for low temperature of external air to avoid the low pressure alarms.

The compressor unloading in chiller mode is managed by the analogue input configured as condenser probe circuit 1 or 2 and determined by CF07 (0=temperature, 1 = pressure)

The compressor unloading in heat pump mode is managed by the analogue input configured as evaporator probe circuit 1 or 2. If not configured the heat pump unloading is managed from the condenser transducer.

30.5 REGULATION

UNLOADING IN CHILLER MODE

When the chiller thermoregulation request begins to start the compressors, if the condenser pressure/temperature is equal or bigger than CO44 setpoint the unloading process, of that circuit probe, is engaged. The bottom display shows, alternated with the measurement, the **b1Cu** or **b2Cu** labels. The number of active compressors/step is determined by the CO49 parameter.

EXAMPLE

Unit with 2 circuits with 3 compressors each.

If Par. CO49 = 2, 2 power steps per circuit, in case of unloading there will be 4 compressor running.

With capacity compressors and with unloading active, to avoid having a not well balanced circuit after reducing the power (step valve on) the resource (the valve) is activated for the time set in CO50 even if the unloading function is not more activated and the thermoregulation requires 100% of power. If CO50=0 the function is disabled and if necessary the valve is turned immediately off to have the 100% of the power.

UNLOAD DE-ACTIVATION in CHILLER MODE

If the temperature decreases under the value determined by (CO44-CO45) setpoint – differential, the unloading is disengaged, the compressors are all available for the thermoregulation.

30.6 OTHER INFORMATION ABOUT THE UNLOADING IN CHILLER

To avoid having long period of unloading function activated when the temperature or the pressure value is continuously within the SET and SET+ differential, if the temperature or the pressure is higher than CO40, the CO48 time delay forces the unloading off for timeout even if the temperature / pressure is not lower than CO44-CO45.

UNLOADING IN HEAT PUMP MODE

The compressor unloading in heat pump mode is managed by the analogue input configured as evaporator probe circuit 1 or 2.

When the heat pump thermoregulation request begins to start the compressors, if the evaporator pressure/temperature is equal or bigger than CO46 setpoint the unloading process, of that circuit probe, is engaged. The bottom display shows, alternated with the measurement, the **b1Cu** (circuit2) or **b2Cu** (circuit2) labels. The number of active compressors/step is determined by the CO49 parameter.

EXAMPLE

Unit with 2 circuits with 3 compressors each.

If Par. CO49 = 1, 1 power steps per circuit, in case of unloading there will be 2 compressor running, 1 per circuit.

With capacity compressors and with unloading active, to avoid having a not well balanced circuit after reducing the power (step valve on) the resource (the valve) is activated for the time set in CO50 even if the unloading function is not more activated and the thermoregulation requires 100% of power. If CO50=0 the function is disabled and if necessary the valve is immediately off to have the 100% of the power.

UNLOAD DE-ACTIVATION in HEAT PUMP MODE

If the evaporator temperature increases the value determined by (CO46+CO47) setpoint +differential, the unloading is disengaged, the compressors are all available for the thermoregulation.

30.7 OTHER INFORMATION ABOUT THE UNLOADING IN HEAT PUMP

To avoid having long period of unloading function activated when the temperature or the pressure value is continuously within the SET and SET+ differential, if the temperature or the pressure is higher than CO46, the CO48 time delay forces the unloading function off for timeout event, even if the temperature / pressure is not lower than CO46+CO47.

31 SOLENOID VALVE FOR LIQUID INJECTION

There are two outputs relay that can be configure as solenoid valve compressor 1 and 2. The function is enabled when:

- For compressor 1: one output relay is configured as solenoid valve compressor 1 and one analogue input is configured as discharge temperature of compressor 1.
- For compressor 2: one output relay is configured as solenoid valve compressor 2 and one analogue input is configured as discharge temperature of compressor 2.

31.1 FUNCTIONNING

When the **compressor is off** the solenoid valve output is **always OFF**. When the compressor is on: if the PTC temperature of the compressor discharge reaches CO51 setpoint the valve turns ON, while if the temperature decreases under C51-CO52 (set- differential) the valve turns off.

ATTENTION

The display resolution is 0.1°C until the read-out is 99.9, over 100°C it is 1°C.

32 WATER PUMP OF THE EVAPORATOR / SUPPLY FAN

32.1 WATER PUMP OF THE EVAPORATOR / SUPPLY FAN (AIR/AIR)

With only one evaporator water pump configured, the parameter **CO19 / CO20** values do not affect the water pump functioning itself. The water pump regulation involves the following modes:

Operative modes of the parameter CO16 of evaporator pump / Supply fan

CO16=0: Not enabled: water pump/supply fan not managed.

Attention: The air / air unit configured with CO16= 0 does not manage the output for integration heaters.

CO16 = 1: Continuous control.

The water pump/ supply fan are running only if the unit is running (chiller, heat pump). After giving the start in chiller or heat pump mode the compressor regulation starts only after the time delay CO17.

The water pump/ supply fan are turned off only when the unit is turned off (stand-by) and, if CO18<>0, the water pump/ supply fan turns off only after the this delay.

When the unit is in stand-by or remote off and the Ar09 =1, if the thermoregulation requires the antifreeze heaters also the water pump is turned on.

CO16 = 2: on compressor demand.

When the compressor turns on also the water pump/ supply fan are turned on. In both chiller and heat pump modes the water pump/ supply fan starts CO17 before the compressor. When the last compressor is turned off the water pump/ supply fan is turned of after the CO18 delay.

When the unit is in stand-by or remote off and the Ar09 =1, if the thermoregulation requires the antifreeze heaters also the water pump is turned on.

The pump is always off when:

Remote OFF from digital input.

Digital input active of the water pump overload.

Digital input active of the evaporator water pump flow with MANUAL alarm.

During the defrost and when the compressor is off in dripping time the pump/supply fan is on.

32.2 HOT START (SUPPLY FAN) ONLY FOR AIR / AIR UNIT IN HEAT PUMP MODE

The hot start function is available only for air/air unit configured with heat pump and it is active only during the heat pump mode.

It allows to start the supply fan only if the evaporating/condensing probe temperature is hot enough to avoid to introduce cold air flows.

FA24 Hot start Setpoint.

It is the temperature setpoint to stop the supply fan when the NTC probe of the evaporator #1 output or the evaporator #2 output or the evaporator common output value is lower.

FA25 Hot start differential

Temperature differential of the hot start function.

33 EVAPORATOR PUMP GROUP

If two relay outputs are configured as evaporator water pump and support pump of the evaporator automatically the pump group control is enabled.

First start-up of the unit: the running hours of the two pumps are both 0, if CO16=1 or 2 (continuous or on compressor demand pump mode) by default the pump #1 is turned on. The successive restart of the unit is made with the pump #2.

During the normal functioning condition when the unit changes from a stand-by /remote off/ power off status to chiller or heat pump mode the pump that is running is switched off and immediately the one with less running hours is turned on.

When the unit goes in stand-by or remote off the pump stays on for the time set in CO18.

When the unit is in stand-by or remote off and the Ar09 =1, if the thermoregulation requires the antifreeze heaters also the water pump is turned on.

33.1 EVAPORATOR WATER PUMP ROTATION

Par. **CO19** <> 0 to enable the function.

During the normal functioning condition, both for chiller and heat pump, if one pump reaches the running hours of the CO19 parameter, the pump is turned off while the other pump is re-activated.

If the CO20 <> 0, before changing from one to the other the two pumps work together for the time set in this parameter. If CO24=0 the rotation is immediate and CO20 is not counted.

ATTENTION

The CO17/CO18 values, on and off delay between compressors and pumps, are calculated also for the pump group.

33.2 EVAPORATOR WATER PUMP ROTATION THROUGH DIGITAL INPUT CONTROL

With two digital inputs configured as overload alarm of water pump and support pump the rotation is enabled when the digital input of the running pump becomes active. That pump is turned off while the other is forced on.

If the digital inputs are configured as evaporator water pump alarm and condenser water pump alarm the active digital input alarm stops the corresponding pump.

Note: During the defrost and when the compressor is off in dripping time the pump is on.

33.3 HOT START

FA25 Hot start Setpoint

Low temperature value of PB2 to stop the supply fan.

This function is available **only** with air / air unit configured as **heat pump** and allows to run the supply fan only when the air temperature is enough hot.

FA26 Hot start differential

Temperature differential of the hot start function.

34 WATER PUMP OF THE CONDENSER

34.1 CONDENSER WATER PUMP CONTROL

If one relay is configured as condenser water pump the **CO24 / CO25** parameter values do not affect the pump functioning..

Water pump regulation:

Operative mode of the condenser water pump parameter CO21

CO21 = 0 Not enabled, pump not controlled.

CO21 = 1 Continuous control. The water pump is running only if the unit is running (chiller, heat pump). After giving the the start in chiller or heat pump mode the compressor regulation starts only after the time delay CO17.

The water pump is turned off only when the unit is turned off (stand-by) and, if $CO23 > 0$, the water pump/ supply fan turns off only after the this delay.

When the unit is in stand-by or remote off and the $Ar09 = 1$, if the thermoregulation requires the antifreeze heaters also the water pump is turned on.

CO21 = 2 on compressor demand.

When the compressor turns on also the water pump is turned on. In both chiller and heat pump modes the water pump/ supply fan starts CO17 before the compressor. When the last compressor is turned off the water pump/ supply fan is turned of after the CO23 delay.

When the unit is in stand-by or remote off and the $Ar09 = 1$, if the thermoregulation requires the antifreeze heaters also the water pump is turned on.

The pump is always off when:

- Remote OFF from digital input.
- Digital input active of the condenser water pump overload.
- Digital input active of the condenser water pump flow with MANUAL alarm.

During the defrost and when the compressor is off in dripping time the pump fan is on.

35 PUMP GROUP OF THE CONDENSER

If two relay outputs are configured as condenser water pump and support pump of the condenser automatically the pump group control is enabled.

First start-up of the unit: the running hours of the two pumps are both 0, if $CO21 = 1$ or 2 (continuous or on compressor demand pump mode) by default the pump #1 is turned on. The successive restart of the unit is made with the pump #2.

During the normal functioning condition when the unit changes from a stand-by /remote off/ power off status to chiller or heat pump mode the pump that is running is switched off and immediately the one with less running hours is turned on.

When the unit goes in stand-by or remote off the pump stays on for the time set in CO23.

When the unit is in stand-by or remote off and the $Ar09 = 1$, if the thermoregulation requires the antifreeze heaters also the water pump is turned on.

35.1 CONDENSER WATER PUMP ROTATION

Par. **CO24** $<> 0$ to enable the function.

During the normal functioning condition, both for chiller and heat pump, if one pump reaches the running hours of the CO24 parameter, the pump is turned off while the other pump is re-activated.

If the $CO25 <> 0$, before changing from one to the other the two pumps work together for the time set in this parameter. If $CO24 = 0$ the rotation is immediate and CO25 is not counted.

ATTENTION

The CO17/CO23 values, on and off delay between compressors and pumps, are calculated also for the pump group.

35.2 CONDENSER WATER PUMP ROTATION THROUGH DIGITAL INPUT CONTROL

With two digital inputs configured as overload alarm of water pump and support pump the rotation is enabled when the digital input of the running pump becomes active. That pump is turned off while the other is forced on.

If only one digital input is configured as condenser water pump alarm or only as condenser water pump alarm the active digital input alarm stops the corresponding pump.

During the defrost and when the compressor is off in dripping time the pump is on.

36 LOAD MAINTENANCE

PARAMETERS CO26..CO31 are the set of the running hour counters of the compressors.

They establish, for each load, the number of running hours limit to display a maintenance message.

If one of these parameters is equal to 0 the maintenance signalling is disabled but the running hours counter remains active.

36.1 COMPRESSOR MAINTENANCE REQUESTS

Label description	ACP1 (maintenance comp. 1) –...ACP6 (maintenance comp. 6)
Activation	Compressor running hours > counter setpoint for that compressor
Reset	Running hour reset (Hour label in Menu function)
Restart	Manual
Icon	 blinking
Actions	Alarm relay and buzzer activated
REGULATIONS	
Actions	Only signalling
Loads	Not modified

The parameters **CO32 / CO33** define the hour set counters for the evaporator water pump / Support evaporator water pump / Supply fan.

They establish the load running hours limit of the pump/s or the supply fan to give a maintenance signalling. If one of these parameters is equal to 0 the maintenance signalling of that load is disabled but the running hours counter remains active.

37 CONDENSER FAN REGULATION

The **FA01** and **FA02** parameters define the operative mode of the condenser fans. The CF68 and CF69 selects which are the output signals.

Par. **CF68** Condenser fan control signal of the circuit #1

0= 0 ÷ 10V

1= 4÷20mA

2= PWM

Par. **CF69** Condenser fan control signal of the circuit #2

0= 0 ÷ 10V

1= 4÷20mA

2= PWM

Par. **FA01** Fan regulation

0 = Output not enabled

1 = always on

2 = ON/OFF step regulation

3 = ON/OFF continuous step regulation

4 = proportional fan speed

Par. **FA02** Fan operative mode

0 = Fan on only if compressor on

1 = Independent from the compressor, off during the stand-by / or from remote OFF

Parameter combination **FA01 – FA02**

Par. **FA01 = 1 + Par. FA02 = 0**

Fans on when the compressor on (the fans work following the same output algorithm)

Par. **FA01 = 1 + Par. FA02 = 1**

Independent from the compressor status but off in stand-by.

Par. **FA01 = 2 + Par. FA02 = 0**

Fans on, with ON/OFF regulation and with temperature/pressure transducer control, only when the compressor is on (at least one relay is configured as fan control). When the compressor turns off also the fans are forced off.

Par. **FA01 = 2 + Par. FA02 = 1**

Fans on, with ON/OFF regulation and with temperature/pressure transducer control, only when the compressor is on (at least one relay is configured as fan control). When the compressor turns off the fans are thermoregulated depending on the condensing temperature/pressure.

Par. **FA01 = 3 + Par. FA02 = 0**

Fans on, with ON/OFF continuous regulation and with temperature/pressure transducer control, only when the compressor is on (at least one relay is configured as fan control). When the compressor turns off also the fans are forced off.

Par. **FA01 = 3 + Par. FA02 = 1**

Fans on, with ON/OFF continuous regulation and with temperature/pressure transducer control, only when the compressor is on (at least one relay is configured as fan control). When the compressor turns off the fans are thermoregulated depending on the condensing temperature/pressure.

Par. **FA01 = 4 + Par. FA02 = 0**

Fans on, with proportional regulation (PWM, 4..20mA, 0.10V) and with temperature/pressure transducer control, only when the compressor is on. When the compressor turns off also the fans are forced off.

Par. **FA01 = 4 + Par. FA02 = 2**

Fans on, with proportional regulation (PWM, 4..20mA, 0.10V) and with temperature/pressure transducer control, only when the compressor is on. When the compressor turns off the fans are thermoregulated depending on the condensing temperature/pressure.

37.1 OUTPUT STEP RELE' CONDENSER FAN

Par FA01 = 2 ON/OFF step regulation

N° 1 circuit with 4 step of ventilation

Step regulation

OUT relè	step n° 1	step n° 2	step n° 3	step n° 4
Out relè step n° 1	step N° 1 ON	step N° 1 OFF	step N° 1 OFF	step N° 1 OFF
Out relè step n° 2	step N° 2 OFF	step N° 2 ON	step N° 2 OFF	step N° 2 OFF
Out relè step n° 3	step N° 3 OFF	step N° 3 OFF	step N° 3 ON	step N° 3 OFF
Out relè step n° 4	step N° 4 OFF	step N° 4 OFF	step N° 4 OFF	step N° 4 ON

Par FA01 = 3 ON/OFF continuous step regulation

N° 1 circuito con quattro gradini di ventilazione

Continuous step regulation

OUT relè	Gradino n° 1	Gradino n° 2	Gradino n° 3	Gradino n° 4
Out relè step n° 1	step N° 1 ON	step N° 1 ON	step N° 1 ON	step N° 1 ON
Out relè step n° 2	step N° 2 OFF	step N° 2 ON	step N° 2 ON	step N° 2 ON
Out relè step n° 3	step N° 3 OFF	step N° 3 OFF	step N° 3 ON	step N° 3 ON
Out relè step n° 4	step N° 4 OFF	step N° 4 OFF	step N° 4 OFF	step N° 4 ON

37.2 PWM OUTPUT FOR FAN CONTROL

If FA01=3 and the fan control boards are connected to the PWM outputs (TF1 and2) take note of the FA03 ,FA04 parameters. The fan start-up is always made at the maximum speed for the time set in FA03, then the speed follows the probe value. The F04 delay, in micro – seconds, allows to adjust the output for each kind of the fan motor.

If FA01=3, when the compressor starts-up and the proportional regulation requires to turn off the fan (cut-off), if FA14≠0 the fan is forced at the minimum speed for the time set in FA14 itself. if FA14=0 the function is disabled.

37.3 CONDENSING UNIT: COMMON OR SEPARATE

FA05 defines the condenser unit

Par. FA05 type of condenser

0= Common condenser unit.

1= Separate condenser units.

If Pa FA05= 0 the outputs, configured as condensing fan control, will follow the same regulation algorithm.

The regulation includes:

- **CHILLER mode:** the maximum probe value compared between the temperature/pressure probe of the two circuits.
- **HEAT PUMP (no evaporator probe configured)** the minimum probe value compared between the condenser temperature/pressure probe of the two circuits.
- **HEAT PUMP (evaporator probe configured)** the minimum probe value compared between the evaporator temperature/pressure probe of the two circuits.

If par. FA05 = 1 and if the evaporating pressure probe are not configured, the fan output controls are separated and are controlled by the condenser temperature/pressure probes. When the evaporator probes are configured, in heat pump the ventilation is controlled by these transducers.

37.4 GRAPH: PROPORZIONAL REGULATION OF CONDENSER FANS

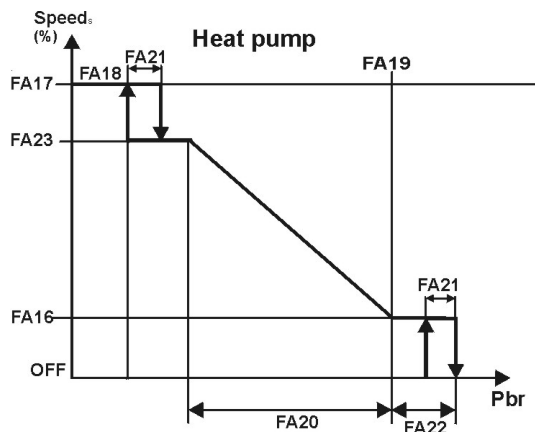
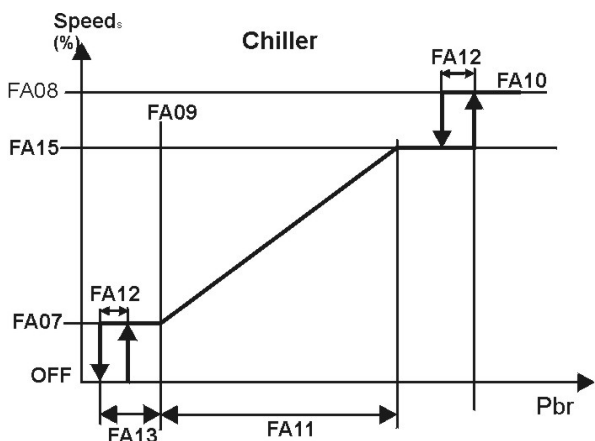

37.5 GRAPH: ON / OFF REGULATION OF THE CONDENSER FAN IN CHILLER MODE

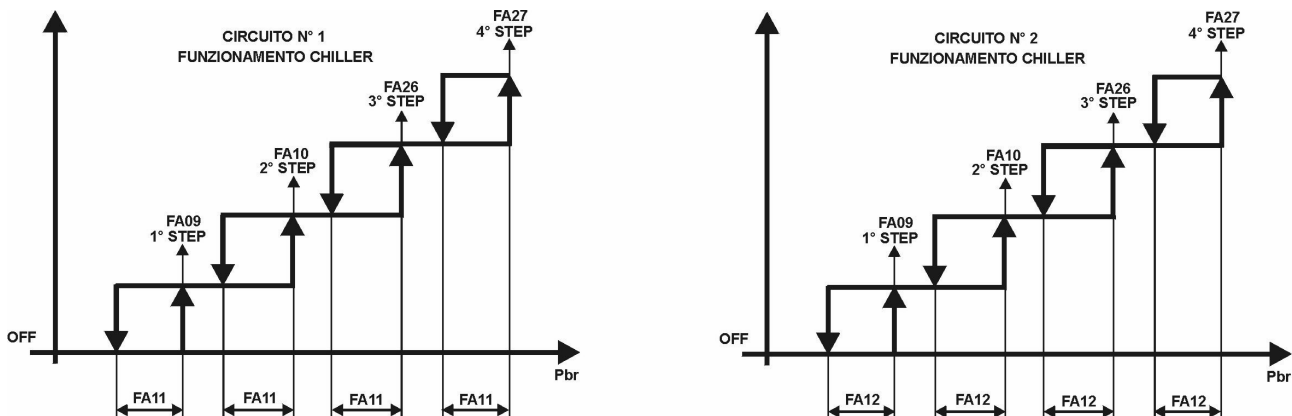

37.6 GRAPH: ON / OFF REGULATION OF THE CONDENSER FAN IN HEAT PUMP MODE

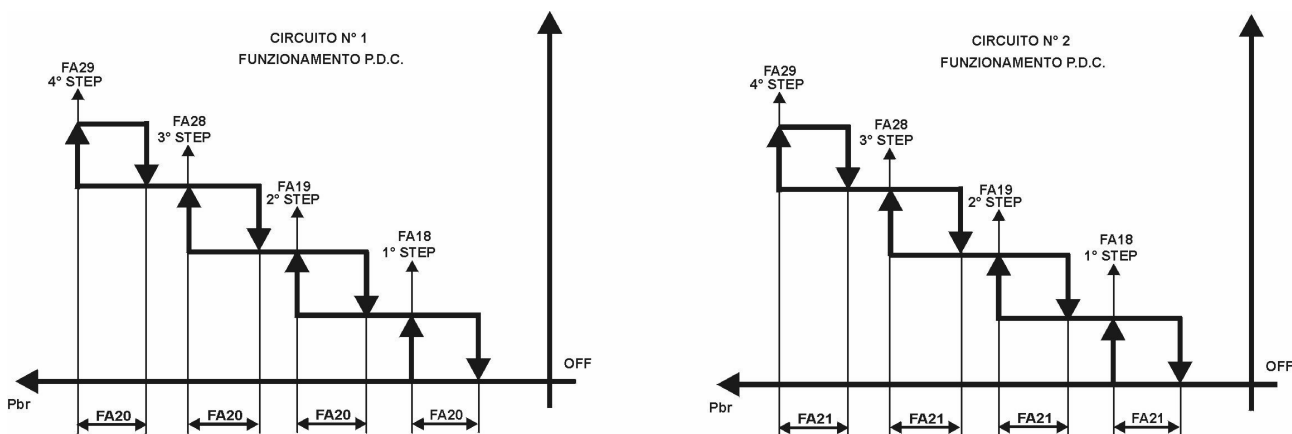

38 DEFROST CYCLE

The defrost cycle starts only if all these steps are determined:

- CF02=1 heat pump unit.
- DF01 <>0: defrost enabled.
- Unit working in heat pump mode and at least one compressor running.
- The condenser/evaporator probe is configured (per circuit) (if the evaporator probe/s is/are defined, the defrost cycle is always controlled by it / them).

38.1 FORCED DEFROST

The function is enabled if the parameter dF19<>0. It allows to make a forced defrost cycle even if the dF09 timeout counting is not expired, when the condensing/evaporating temperature/pressure is lower than dF20 setpoint for the dF19 time counting. If during the dF19 counting the condensing/evaporating temperature/pressure rises above the value dF20+dF21 (set+differential) the function is disabled and the tF19 time is reloaded.

ATTENTION: the forced defrost is not related to the dF09 /dF06 delay times, therefore the forced defrost cycle, if condition are OK, is immediately executed.

38.2 COMBINED DEFROST

The function is enabled if one of the digital input is configured as NTC temperature for combine defrost of the 1st or 2nd circuit. This probe detects the external air temperature of the condenser (evaporator in heat pump). and its temperature value determines the start and the stop of the defrost cycle.
Description of the functioning:

The count-down to the defrost cycle starts when the temperature/pressure of the probe, configured as condensing/evaporating circuit 1 or 2 probe, is lower than dF02 parameter.

After the dF09 counting the instruments checks the temperature probe value (configured as combined defrost circuit 1 or 2) and if it is lower than dF10 (temperature setpoint to start the defrost of the circuit1) or dF12 (temperature setpoint to start the defrost of the circuit2) the defrost cycle starts otherwise the unit still runs in heat pump mode.

When the temperature decreases under the dF10 or dF12 values the defrost immediately start.

The defrost ends when the NTC combined defrost probe 1 or 2 increases over dF11 (circuit1) or dF13(circuit2).

If the defrost is enabled the display allows to show the external temperature on the top display and the labels **dEF1** (circuit1) or **dEF2**(circuit2) on the bottom display aof the circuit read-out function.

38.3 MANUAL DEFROST

The manual defrost key function is enabled if the unit is on with at least one compressor running.

The defrost start temperature/pressure of the controlled probe must be lower than dF02 setpoint value while if the combined defrost is active the detected temperature must be lower than dF10 or dF12.

At this point by pushing **SET + UP** for more than **5** seconds the manual defrost starts.

ATTENTION: the manual defrost is not related to the dF09 /dF06 delay times, therefore the forced defrost cycle, if condition are OK, is immediately executed for both circuits.

38.4 DEFROST START CONDITION WITH TWO CIRCUIT UNIT

Parameter involved: dF22

0= Independent

1= Only if both circuit conditions are satisfied

2= At least one circuit condition is satisfied

38.5 END OF THE DEFROST IN A TWO CIRCUITS WITH ONE CONDENSING FAN CONTROL UNIT

Parameter involved: dF23

0= Independent

1= Both circuits have reached the conditions to stop the defrost

2= At least one circuit has reached the end defrost condition

Table of defrost cycle for units with 2 circuits

Parameter	dF23=0	dF23=1	dF23=2
dF22=0	Yes	not possible (ACF1)	not possible (ACF1)
dF22=1	Yes	Yes	Yes
dF22=2	not possible (ACF1)	Yes	not possible (ACF1)

ATTENTION:

The configuration error ACF1 is displayed if the parameter value of dF22 and dF23 is not permitted.

For only one condensing unit the dF22 and dF23 values must be not equal to 0.

38.6 AUTOMATIC DEFROST PROCEDURE

Phase 1: time counting of dF09 (Interval defrost of the same circuit), unit is working in heat pump mode and at least one compressor is running, the defrost led  is blinking , the condensing-evaporating temperature or pressure must be lower than dF02 value. (see start probe par. dF24)

Functioning of the time counter:

1. **The dF09 counter is reloaded** se if the power supply fails, after a defrost cycle and after the unit changes from chiller to HP.
2. **The dF09 counter is stopped** if the last compressor turns off or if the pressure-temperature of the condensing-evaporating probe becomes higher than dF02 parameter value.
3. **The counter is decremented** if the condensing or evaporating temperature-pressure probe value becomes lower than the dF02 parameter value.

2nd phase: starts after the dF09 counting and check if the initial condition are satisfied to defrost

If one digital input si configured as "defrost end" of the circuit 1 or 2 and the contact is active, the unit waits until the contact is deactivated.

Probe configured as combined defrost NTC of circuit 1 or 2

- If the condensing or evaporating probe value of the 1st circuit is lower than dF10 and lower than dF12 for the 2nd circuit the process step on the 3rd phase.
- Otherwise th unit waits until the probe values decrease under dF10 and dF12.

If any of the probe is configured as combined defrost NTC the process steps on the 3rd phase.

When the circuit condition are satisfied to execute the 3rd phase the display shows the dF1 (circuit1) and dF2 (circuit2) labels.

To enter the **FASE 3** of the defrost the following conditions have to besatisfied:

3rd : inversion valve management Par. **dF07** (OFF compressor before the defrost)

If dF07=0: the valve is activated without stopping any compressor and the defrost cycle is immediately activated. If the thermoregulation or the dF14 parameter require more compressors the dF16 (on compressor delay during defrost cycle) is loaded.

If dF07 <> 0:

1. The compressors and the steps are turned off (the compressor/s led is blinking, the defrost led  is on)
2. Start the dF07 / 2 (half time) time counting;
3. The valve is activated;
4. Start the dF07 / 2 (half time) time counting.

The 4th phase start condition: if the thermoregulation or the dF14 parameters require to turn ON more than one compressor for circuit, the delay on time between the compressors depends on the parameter dF16.

The partialization/s: if configured always OFF during the defrost cycle, the compressor is always 100%.

- if dF14=1 (all the circuit #1 resources are forced to ON): during the defrost cycle the compressors and steps of the circuit #1 are ON while, if dF14=0, compressors and steps are thermoregulated.
- if dF15=1 (all the circuit #2 resources are forced to ON): during the defrost cycle the compressors and steps of the circuit #2 are ON while, if dF15=0, compressors and steps are thermoregulated.

4th PHASE: Defrost ON

Parameter involved: **dF17** (condensing fan management)

- If dF17=0: The condensing fan are always off;
- If dF17=1: The condensing fans start if the condensing temperature-pressure value is higher than dF18, they will following the normal chiller thermoregulation algorithm.

ATTENTION during the defrost cycle, both for chiller and the heat pump modes, the fan are controlled with the condensing probe even if the evaporator probe is present and configured.



The 4th phase lasts at least for the dF04 time counting and can terminate for these conditions:

1. If dF02=0:
 - The combined NTC probe value is higher than dF11 of the 1st circuit;
 - The combined NTC probe value is higher than dF13 of the 2nd circuit;
 - When the condensing-temperature probe/s is/are higher than dF03 parameter value.
2. If dF02=2: the dF05 counting, maximum defrost timeout, is expired, step on 5th PHASE;
3. If dF02=3, if the end defrost digital input is deactivated, step on 5th PHASE.

5th PHASE: Inversion valve management Par. **dF08** (OFF compressor after defrost cycle)

If dF08 = 0 the valve is turned without stopping the compressors, the defrost ends and all the regulation restarts, the defrost led  in heat pump is off).

If dF08 <> 0:

1. All the compressors and steps are turned off (the compressor leds are blinking and the defrost led  is on)
2. Start the dF08 / 2 (half time) time counting;
3. Inversion valve de-activated
4. Start the dF07 / 2 (half time) time counting; all the regulation restarts and the defrost led  in heat pump is off).

38.7 OTHER INFORMATION ABOUT THE DEFROST

FOR ALL THE UNIT WITH SAME DEFROST FOR THE TWO CIRCUITS

If the unit is configured with one condenser see parameter FA05:

0= common condenser;

1= separated condensers.

For FA05=0, common condenser, the defrost of the two circuits starts at the same time.

ATTENTION

Before starting the 3rd phase, the dF06 counting, time delay between two circuits defrost, must be expired.

ATTENTION

If the defrost ends because of the dF05 counting (Maximum defrost time) and the dF02 configuration or with the end defrost contact, the bottom display will show, alternated with the normal measurement value, the label **b1dF** (circuit #1) or **b2dF** (circuit #2) labels to indicate the defrost end alarms.

38.8 DEFROST PARAMETER DESCRIPTION

ATTENTION IT IS NOT POSSIBLE TO DO MODIFY THE dF PARAMETERS WHEN THE DEFROST CYCLE IS RUNNING.

dF01 Defrost mode

0 = Defrost not enabled;

1 = Temperature/pressure defrost. The dF09, time delay to the defrost, starts when the temperature decreases under the dF02 setpoint. The Defrost cycle end is determined by temperature/pressure.

2 = Time duration defrost. The dF09, time delay to the defrost, starts when the temperature decreases under the dF02 setpoint. (see start probe par. dF24). The Defrost cycle end is determined by the maximum duration dF05.

3 = Defrost from digital input. The dF09, time delay to the defrost, starts when the temperature decreases under the dF02 setpoint. (see start probe par. dF24) The Defrost cycle end is determined by the active digital input.

dF02 Temperature / pressure to begin the time counting to next defrost.

It allows to program a setpoint under which the dF09 starts counting.

dF03 Temperature / pressure to end the defrost.

It allows to program a temperature/pressure setpoint value to determines the end of the defrost when the probe value is rising.

dF04 Minimum duration of the defrost

It determines the minimum defrost time duration after starting the defrost itself even if the conditions are not more satisfied.

dF05 Maximum duration of the defrost

If dF01=2, it determines the maximum duration of the defrost and even if, for the other cases, the end defrost condition are still to be satisfied.

dF06 defrost delay time between the 1st and the 2nd circuit.

After the interval dF09 determined by the defrost request of one of the circuits the other 2nd circuits must wait also the time dF06 before defrosting.

dF07 Compressor off time before the defrost (the led of the compressor is blinking)

After the dF09 delay and before activating the defrost, the compressors are stopped for the dF07 time.

Exactly in the middle of the dF07 time the 4-way valve is activated to equalise the pressure of the unit and when dF07 is completely expired the compressors and the defrost can start.

This procedure does not respect the compressor on delay protection therefore the compressor is immediately turned off and then on. If dF07 = 0 the compressor is not stopped and the 4-way valve is immediately turned.

dF08 Compressor off time after the defrost (the led of the compressor is blinking)

After the defrost cycle the compressors are stopped for the dF08 time.

Exactly in the middle of the dF07 time the 4-way valve is activated to equalise the pressure of the unit and to drain the external exchange unit, when dF08 is completely expired the unit restart in heat pump mode.

This procedure does not respect the compressor on delay protection therefore the compressor is immediately turned off and then on. If dF08 = 0 the compressor is not stopped and the 4-way valve is immediately turned.

DF09 Delay time to next defrost

It starts when the condensing/evaporating temperature/pressure probe value is lower than dF02 setpoint. This time is reloaded if the power supply fails, after a defrost cycle or from a digital input request of defrost.

The time counting is interrupted if the compressor is turned off or if the temperature/pressure is higher than dF02.

dF10 Temperature setpoint to start a combined defrost of the circuit #1.

It allows to set a temperature value to determines the beginning of a combined defrost.

After the dF09 counting the NTC probe of the combined defrost of the circuit #1 is compared to the dF10 setpoint, if the value is lower the defrost starts otherwise the unit runs in heat pump mode and when the temperature decreases under dF10 the defrost immediately starts.

dF11 Temperature setpoint to end a combined defrost of the circuit #1.

It allows to set a temperature value to determine the end of a combined defrost.

When the NTC probe of the combined defrost of the circuit #1 becomes higher than dF11 setpoint the defrost cycle stops.

dF12 Temperature setpoint to start a combined defrost of the circuit #2.

It allows to set a temperature value to determine the beginning of a combined defrost.

After the dF09 counting the NTC probe of the combined defrost of the circuit #2 is compared to the dF12 setpoint, if the value is lower the defrost starts otherwise the unit runs in heat pump mode and when the temperature decreases under dF12 the defrost immediately starts.

dF13 Temperature setpoint to end a combined defrost of the circuit #2.

It allows to set a temperature value to determine the end of a combined defrost.

When the NTC probe of the combined defrost of the circuit #2 becomes higher than dF13 setpoint the defrost cycle stops.

dF14 All the resources on during the defrost of the circuit #1

0= Not enabled

1= Enabled

dF15 All the resources on during the defrost of the circuit #2

0= Not enabled

1= Enabled

dF16 Compressor step delay time in defrost.

dF17 Condensing fan control during defrost and dripping cycle

0= Not enabled

1 = Enabled in defrost

2= Enabled in defrost and in dripping time

If dF17 = 0: During the defrost the fan control is not active.

If dF17 = 1: when the condensing temperature/pressure value increases over dF18 the fans are turned on. the fan control is determined by the same algorithm used in chiller mode.

If dF17 = 2: during the dripping time (dF08 <>0) the fan are turned on for the time duration set in dF08 .

dF18 Pressure / temperature setpoint to force the fans on during the defrost

When the temperature/pressure rises over this value the fan are turned on at the maximum speed.

dF19 Time delay before starting a forced defrost

It determines a delay time before starting the defrost cycle

dF20 Temperature / pressure setpoint to force a defrost

It determines a temperature/pressure setpoint under which the dF19 starts counting, when dF19 is expired if the temperature/pressure is still lower than dF20 the defrost is immediately executed.

ATTENTION If during the dF19 counting the temperature rises over dF20+dF21(differential) the process is aborted and the dF19 time reloaded.

dF21 Forced defrost differential

dF22 defrost mode for unit with two circuits

Operative mode:

0= Independent

1= The condition are satisfied in both circuits

2= At least one circuit has reached the start condition

dF23 It determines the end of the defrost for unit having two circuit and common condensing ventilation

Operative mode:

0= Independent

1= The end defrost condition are satisfied In both circuits

2= At least one circuit has reached the end defrost condition

dF24 Start / stop defrost probe

Start / stop defrost from analog input

0= start and stop with condenser temperatur / pressure probe

1= start with evaporator pressure probe / stop with condenser temperatur / pressure probe

2= start with condenser temperatur / pressure probe / stop with evaporator pressure probe

3= start and stop with evaporator pressure probe

39 RECOVERY

The recovery function is Enabled if:

- 1 Par. **rC01** not equal to 0.
- 2 Chiller running mode.
- 3 The recovery key is pushed to enable the function and the recovery led is on.
- 4 The condensing temperature / pressure is lower than set rC06 –rC07 (differential).
- 5 The input/output resources are configured
- 6 The remote recovery digital input is activated.

The recovery function is NOT Enabled if:

- 1 Par. **rC01** = 0.
- 2 Heat pump running mode, remote OFF or stand by.
- 3 The recovery key is pushed to disable the function and the recovery led is on
- 4 The condensing temperature / pressure is higher than set rC06.
- 5 The input/output resources are not properly configured (alarm ACF9).
- 6 The remote recovery digital input is not activated.

NECESSARY RESOURCE FOR THE RECOVERY OF THE CIRCUIT #1

Output relay configured as valve for recovery circuit #1.
Remote recovery digital input for circuit #1.
Condenser probe of the circuit #1.

NECESSARY RESOURCE FOR THE RECOVERY OF THE CIRCUIT #2

Output relay configured as valve for recovery circuit #2.
Remote recovery digital input for circuit #2
Condenser probe of the circuit #2.

39.1 UNIT WITH TWO SEPARATE HYDRAULIC CIRCUITS

FUNCTIONING

Par. **rC01** = 1 unit with two separate circuits:

CIRCUIT # 1

With the recovery function enabled, the unit running in chiller and with the temperature/pressure proper condition, the unit can start the recovery of the first circuit if the corresponding digital input is active. When the digital input is active the relay of the valve for the recovery of the first circuit is activated.

CIRCUIT # 2

With the recovery function enabled, the unit running in chiller and with the temperature/pressure proper condition, the unit can start the recovery of the second circuit if the corresponding digital input is active. When the digital input is active the relay of the valve for the recovery of the second circuit is activated.

After starting the function, if the digital input becomes not active the recovery function runs for the time set in rC04 before stopping..

Between the end and the next recovery function the instrument waits the time set in the parameter rC05 even if the digital input is activated again.

RECOVERY START AND STOP OF THE TWO CIRCUITS CONFIGURED WITH CAPACITY STEPS

During the start and the stop of the fuction the time delay rC02 and rC03 are not counted and the valve is immediately turned on or off.

RECOVERY START OF THE TWO CIRCUITS CONFIGURED WITH MORE THAN ONE CAPACITY STEP

Circuits 1 and 2 configured with more than one step of power (eg each circuit with three compressors), if the thermoregulation requires to turn on one or more resources and the recovery is activated from the digital input the unit turns on only one step and then waits the rC02 delay (this delay keep off all the other steps after the recovery is started). After the delay the recovery valve is turned on and, after the rC03 time (this delay keeps off all the other steps after the recovery is started), the other resources if necessary are turned on.

RECOVERY STOP OF THE TWO CIRCUITS CONFIGURED WITH MORE THAN ONE CAPACITY STEP

Circuits 1 and 2 configured with more than one step of power (eg each circuit with three compressors). After the rC04 time delay (minimum on time of the recovery function when activated) if the digital input of the recovery is not active the units stops the new resources for the time set in rC02. After this delay the recovery valve is turned off and the regulation restarts with its normal running condition.

RECOVERY START OF THE TWO CIRCUITS WITH ALL THE CAPACITY STEPS ACTIVATED

When the system is running with 100% (eg all the three compressor of a circuit are on) of power and the digital input start the recovery function: before turning on the recovery valve one of the step (depending on the time running hours), is turned off for the time set in rC02. After rC02 the recovery valve is turned on. Then, after the rC03 time (this delay keeps off all the other steps after the recovery is started) the resource forced off if necessary is turned on again.

RECOVERY STOP OF THE TWO CIRCUITS WITH ALL THE CAPACITY STEPS ACTIVATED

When the system is running with 100% (eg all the three compressor of a circuit are on) of power and the digital input stop the recovery function: after the rC04 time delay (minimum on time of the recovery function when activated) and before turning off the recovery valve, one of the step is turned off for the time set in rC02. When the delay is expired the unit turns off the recovery valve and and the regulation restarts with its normal running condition.

ATTENTION:

For both the circuits: when the compressor are off because of the thermoregulation and the digital input of the recovery function is active, the recovery valve is disabled.

39.2 UNIT WITH TWO HYDRAULIC CIRCUIT WORKING IN PARALLEL

FUNCTIONING

Par. rC01 = 2 unit with two circuits working in parallel:

The recovery function from the digital inputs is divided in two steps:

UNIT WITH ONE CIRCUIT RUNNING

If the recovery function is enabled and if the condenser temperature/pressure condition are within the limits that circuit starts the recovery when one of the digital inputs is activated. With active digital input the recovery valve of the circuit is on.

UNIT WITH BOTH THE CIRCUITS RUNNING

If recovery function is enabled, if the condenser temperature/pressure condition are within the limits the circuit #1 starts the recovery (recovery valve #1 on) when the digital input #1 is activated and the circuit #2 starts the recovery (recovery valve #2 on) when the digital input #2 is activated.

After starting, the recovery function will run at least for the time set in parameter rC04 (minimum time with recovery on). Between the end of a recovery cycle and the next start the unit waits the time set in Par. rC05 before starting it again.

RECOVERY START-STOP OF THE CIRCUITS 1 AND 2 CONFIGURED WITH ONE STEP EACH

Both for recovery start or stop, the delay time rC02 and rC03 are not counted and the recovery valve is immediately turned on or off.

RECOVERY START OF THE TWO CIRCUITS CONFIGURED WITH MORE THAN ONE CAPACITY STEP

Circuits 1 and 2 configured with more than one step of power (eg each circuit with three compressors), if the thermoregulation requires to turn on one or more resources and the recovery is activated from the digital input the unit turns on only one step and then waits the rC02 delay (this delay keep off all the other steps after the recovery is started). After the delay the recovery valve is turned on and, after the rC03 time (this delay keeps off all the other steps after the recovery is started), the other resources if necessary are turned on.

RECOVERY STOP OF THE TWO CIRCUITS CONFIGURED WITH MORE THAN ONE CAPACITY STEP

Circuits 1 and 2 configured with more than one step of power (eg each circuit with three compressors). After the rC04 time delay (minimum on time of the recovery function when activated) if the digital input of the recovery is not active the units stops the new resources for the time set in rC02. After this delay the recovery valve is turned off and the regulation restarts with its normal running condition.

RECOVERY START OF THE TWO CIRCUITS WITH ALL THE CAPACITY STEPS ACTIVATED

When the system is running with 100% (eg all the three compressor of a circuit are on) of power and the digital input start the recovery function: before turning on the recovery valve one of the step (depending on the time running hours), is turned off for the time set in rC02. After rC02 the recovery valve is turned on. Then, after the rC03 time (this delay keeps off all the other steps after the recovery is started) the resource forced off if necessary is turned on again.

RECOVERY STOP OF THE TWO CIRCUITS WITH ALL THE CAPACITY STEPS ACTIVATED

When the system is running with 100% (eg all the three compressor of a circuit are on) of power and the digital input stop the recovery function: after the rC04 time delay (minimum on time of the recovery function when activated) and before turning off the recovery valve, one of the step is turned off for the time set in rC02. When the delay is expired the unit turns off the recovery valve and and the regulation restarts with its normal running condition.

ATTENTION:

For both the circuits: when the compressor are off because of the thermoregulation and the digital input of the recovery function is active, the recovery valve is disabled.

40 CONDENSER TEMPERAURE / PRESSURE CONDITION TO ENABLE/DISABLE THE RECOVERY CYCLE

The recovery can be disabled depending on the condenser condition to avoid a possible high pressure alarm. The function can be executed by programming the analogue input as condenser transducer 1 or 2 (Par **CF07=0** temperature control or **CF07= 1** pewsure control).

FUNCTIONING

40.1 RECOVERY DISABLED

With the recovery function is activated: if the temperature/pressure is equal or higher than the set rC06 (limit of the recovery cycle) the recovery cycle, of the circuit detected by that transducer, is disabled. When the recovery is disabled the bottom display shows the following blinking icons: **b1rC** = for circuit 1, **b2rC** = for circuit 2.

40.2 RECOVERY ENABLED

If the temperature/pressure decreases under the set rC06-rC07 (differential) the recovery cycle, of the circuit detected by that transducer, is enabled again.

40.3 NOTE ABOUT RECOVERY ENABLED/DISABLED

To avoid long period of time with recovery function disabled and the temperature/pressure within the range rC06-rC07, the units starts counting the delay set in rC08. After this delay if the decreasing temperature is still within the rC06-rC07 range, the recovery cycle is forced on again.

41 MESSAGES - ALARM CODES

the alarm codes are defined by letters and numbers:

Alarm typology:

- **A** = alarm of the unit
- **b** = alarm of the circuit
- **C** = alarm of the compressor

41.1 AP1 - AP2 - AP3 - AP4 - AP5 - AP6 - AP7 - AP8 - AP9 - AP10 - AP11 - AP12 PROBE FAILURE

Label on display	AP1 = PB1 probe alarm... AP10 = PB10 regulator probe alarm AP11 keyboard N° 1 probe alarm AP12 keyboard N° 2 probe alarm
Reason	Probe configured but the read-out is not in the range
Reset	Probe not configured or probe in the right range
Restart	Automatic
Icon	blinking 
Action	Alarm Relay + and buzzer on

41.2 AEFL: EVAPORATOR FLOW ALARM (DIFFERENTIAL PRESSURE SWITCH)

Label o the display	AEFL evaporator flow alarm
Origin	Available only for air/water - water/water units Digital input active for the time set in AL15 after the water pump is on and, after the digital input itself is activated, for the time set in AL17.
Reset	Digital input not active for the time AL18.
Restart	Automatic – Manual after AL16 events per hours (Reset procedure in Menu function).
Icon	Blinking Flow!
Action	Alarm Relay + and buzzer on only during normal running conditions.

41.3 ACFL: CONDENSER FLOW ALARM (DIFFERENTIAL PRESSURE SWITCH)

Label o the display	ACFL condenser flow alarm
Origin	Available only for air/water - water/water units Digital input active for the time set in AL15 after the water pump is on and, after the digital input itself is activated, for the time set in AL17. Alarm not enable if AL14=0 Alarm enabled in chiller only if AL14=1 Alarm enabled in heat pump only if AL14=2 Alarm enabled in chiller and heat pump if AL14=3
Reset	Digital input not active for the time AL18.
Restart	Automatic – Manual after AL16 events per hours (Reset procedure in Menu function).
Icon	Blinking Flow!
Action	Alarm Relay + and buzzer on only during normal running conditions.

ATTENTION

The alarm relay and the buzzer are activated only if the alarm appears during normal running conditions.

When the temperature setpoint has been reached and CO16/CO21= 2, the icon **Flow!** blinks without alarm.

NOTE ABOUT THE FLOW ALARM

CO16 / CO21=0 Water pump not enabled.

The alarm is managed only if one digital input is configured as flow switch, **the restart is always automatic.**

CO16 / CO21=1 Water pump with continuous control.

The alarm is managed only if one digital input is configured as flow switch, **the restart is always automatic, in stand-by or remote OFF (pump off)**, it becomes **manual** after AL16 events per hour.

In chiller or heat pump only. During the functioning of the unit any flow alarm stop the loads described in the table, the water pump follow its regulation algorithm and is turned off, after AL16 events per hours it is completely locked.

CO16 / CO21=2 Compressor on – pump on

The alarm is managed only if one digital input is configured as flow switch, **the restart is always automatic, in stand-by or remote OFF (pump off)**, it becomes **manual** after AL16 events per hour.

During the functioning of the unit any flow alarm stop the loads described in the table, the water pump follow its regulation algorithm and is turned off, after AL16 events per hours it is completely locked.

MANUAL RESTART OF THE FLOW ALARM

After AL16 events/hour it is necessary to enter the function Menu to reset the alarm itself. The alarm message **DOES NOT DISAPPEAR** if the alarm condition is still on. The water pump, if configured, can start and the alarm is by-passed for AL18 seconds.

AL15 Alarm flow delay after on pump.

When the water pump starts the AL15 delay stops any flow alarm to reach the normal flow condition.

AL16 Maximum number of flow alarm events per hour.

It determines maximum number of flow alarm events per hour before change the unit restart from automatic to manual. when the alarm becomes manual the water pump is locked.

ATTENTION

With air/water or water/water units and CF01=1,2 the minimum number of events per hour is 1.

AL17 Active flow input duration

Within this time the flow alarm must be active and after AL17 is expired the alarm is signalled. The counter starts after AL15 and allows to filter the improvise flow reduction or the possible bubbles of air.

AL18 Not active flow input duration

Within this time the flow alarm must be not active and, after this time, the previous alarm is automatically reset (if automatic) or, if manual, the unit can be restarted.

41.4 ATSF: OVERLOAD ALARM OF THE SUPPLY FAN

Label o the display	AtSF: Overload alarm of the supply fan
Origin	CF01=0: After on fan when the ID is activated for AL15 time. After on pump when the ID is activated for AL17.
Reset	Digital input not active for AL18 time
Restart	Automatic – Manual after AL16 events/hour (Reset procedure in Menu function).
Icon	Blinking Flow!
Action	Alarm relay + buzzer ON

MANUAL RESET OF THE OVERLOAD ALARM OF THE SUPPLY FAN

After AL16 events/hour it is necessary to restart manually the unit (reset procedure in Function Menu with blinking label **rSt** if the alarm is not active from AL18 otherwise label **NO** (can not be reset)). Push SET key to reset the alarm, the label disappears, the fan restarts and the alarm is by-passed for AL15 time delay to allow the start-up if within this interval the alarm does not appear again.

41.5 ATE1 - ATE2 EVAPORATOR PUMP OVERLOAD ALARM

Label o the display	AtE1 (overload pump alarm of evaporator 1) AtE2 (overload pump alarm of support evaporator 2)
Origin	Active ID when it is configured as overload pump of evaporator 1 Active ID when it is configured as overload pump of support evaporator 2.
Reset	With active digital input
Restart	Manual (reset procedure in function menu).
Icona	Blinking 
Action	Alarm relay + buzzer ON

41.6 ATC1 - ATC2 CONDENSER/RECOVERY PUMP OVERLOAD ALARM

Label o the display	AtC1 (overload pump alarm of condenser 1) AtC2 (overload pump alarm of support condenser 2)
Origin	Active ID when it is configured as overload pump of condenser 1 Active ID when it is configured as overload pump of condenser 2.
Reset	With active digital input
Restart	Manual (reset procedure in function menu).
Icona	Blinking 
Action	Alarm relay + buzzer ON

41.7 AEE EEPROM ALARM

Label o the display	AEE
Origin	Wrong eeprom data
Reset	-----
Restart	Manual
Icona	Blinking 
Action	Alarm relay + buzzer ON

41.8 AFR: POWER SUPPLY FREQUENCY ALARM

Label on the display	AFr (Line frequency alarm)
Origin	The power supply frequency is not equal to the Par. CF81 + tolerance
Reset	Ferquency control parameter adjusted, disabled CF81 = 2, frequency within the tolerance
Restart	Automatic
Icona	Blinking 
Action	Alarm relay + buzzer ON

41.9 ALOC: GENERIC ALARM WITH STOP REGULATION

Label on the display	ALOC: generic alarm from digital input with stop regulation
Origin	Digital input configured as generic alarm with stop regulation active after the delay in Par. AL43
Reset	Digital input configured as generic alarm with stop regulation not active after the delay in Par. AL44
Restart	Automatic – It becomes manual after AL42 events/hour (procedura di reset in menù funzioni). Logged only if manuale
Icona	Blinking 
Action	Alarm relay + buzzer ON
REGULATION	
Alarm	Alarm relay + buzzer ON
Other loads	OFF

ATTENTION

If during AL44 the alarm stop and start again the AL44 time delay is reloaded.

41.10 ACF1 - ACF2 - ACF3 - ACF4 - ACF5 - ACF6 - ACF7 - ACF8 - ACF9 CONFIGURATION ALARM OF THE UNIT

Significato label display	<p>ACF1</p> <ul style="list-style-type: none"> Heat pump unit without 4-way valve not configured Defrost wrong parameters (dF22/23) <p>ACF2</p> <ul style="list-style-type: none"> Condensing control without probe configuration. (one probe per circuit with 2 separate circuits, at least 1 probe for common cond.) Fan proportional control algorithm not respected: FA09 + FA11 + FA12 < FA10 FA12 < FA13 FA07 < FA15 < FA08 Fan proportional control algorithm not respected and pump enabled: FA18 + FA21 + FA20 < FA19 FA21 < FA22 FA16 < FA23 < FA17 Fan ON - OFF regulation algorithm not respected: FA09 < FA10 Fan ON - OFF regulation algorithm not respected and pump enabled: FA18 < FA19 With pump and defrost enabled there are no evaporating/condensing probes. With triac regulation (CF68, CF69 = 2) the power supply configuration is Vcc (CF83 = 0) <p>ACF3</p> <ul style="list-style-type: none"> Two digital/ analogue inputs configured with the same function or without the necessary resources (es. compressor # 3 overload but compressor#3 relay not configured) <p>ACF4</p> <ul style="list-style-type: none"> CF79 = 1 and its digital input not configured or CF79 = 2 and no external temperature probe configured. <p>ACF5</p> <p>Circuito # 2 not configured but at least one of its resources are present (relay: solenoid pump-down, heaters, inversion valve, fan condensing ON - OFF, recovery, auxiliary)</p>
----------------------------------	---

	<p>ACF6</p> <ul style="list-style-type: none"> • The total number of compressor of the 2 circuits (CF04 + CF05) is: <ul style="list-style-type: none"> √ > 6 √ > 4 with no direct compressor start-up (CO10 ≠ 0) or the number of steps is ≠ 0 (CF06), √ > 2 and the intermittent valve is configurated with ON (CO08) and OFF (CO09) ≠ 0 • Pump-down function but at least in one circuit <ul style="list-style-type: none"> √ The pump-down solenoid relay is not present √ No pump-down pressure switch or evaporating probe when <ul style="list-style-type: none"> <input type="checkbox"/> the pump-down is enabled with unit in start Or <input type="checkbox"/> No low pressure switch configurated. • The compressor configuration with CF04 and CF05 but not the relay outputs: <ul style="list-style-type: none"> √ Main √ Intermittent valve when enabled with the ON / OFF time, CO08 / CO09 ≠ 0 √ When the by-pass time ≠ 0 and there is no partialization or by-pass valve configurated √ Motor part_2 / centre of the star with part-winding or star-delta √ The necessary step valve configurated • One relay is configurated <ul style="list-style-type: none"> √ Too much compressors √ Intermittent valve when ON / OFF time CO08 / CO09 ≠ 0 √ By-pass gas when the by-pass = 0 √ Compressor Motor coil 2 / center of the star with direct compressor start-up • Too much step valve <p>ACF7</p> <p>Evaporator pump</p> <ul style="list-style-type: none"> √ Enabled (CO16 ≠ 0) but the relay is not configurated √ Not enabled (CO16 = 0) but the relay is configurated <p>Condenser pump</p> <ul style="list-style-type: none"> √ Enabled (CO21 ≠ 0) but the relay is not configurated √ Not enabled (CO21 = 0) but the relay is configurated <p>ACF8</p> <ul style="list-style-type: none"> • Thermoregulation probe ✓ The thermoregulation probe (in chiller with ST09, in heat pump when enabled with ST10) is not properly configurated (it does not exist or it is not a NTC) <p>ACF9</p> <ul style="list-style-type: none"> • Recovery cycle enabled Par. rC01 ≠ 0 ✓ only some of these resources are configurated: condensing probe, recovery digital input, recovery relay, or no outputd is configurated.
Causa attivazione	Programmazione errata
Reset	Programmazione corretta
Riarmo	Automatico
Icona	 lampeggiante
Azione	Relè allarme + buzzer attivato

41.11 ARTF CLOCK FAILURE

Label o the display	ArtF (clock failure)
Origin	Clock chip failure
Reset	Change clock chipset
Restart	Manual in function menu
Icona	Blinking 
Action	Alarm relay + buzzer ON
Regulation	
Loads	Not changed
Energy saving	Disabled if based on RTC

Unit ON/OFF	Disabled if based on RTC
-------------	--------------------------

41.12 ARTC CLOCK ALARM

Label o the display	ArtC (clock alarm)
Origin	Wrong setting
Reset	Clock adjusted
Restart	Manual in function menu
Icona	Blinking 
Action	Alarm relay + buzzer ON
Regulation	
Loads	Not changed
Energy saving	Disabled if based on RTC
Unit ON/OFF	Disabled if based on RTC

41.13 AEUn: UNLOADING ALARM FROM HIGH TEMPERATURE OF THE EVAPORATOR WATER INLET

Label o the display	AEUn Unload signalling from evaporator
Origin	During normal running condition when the temperature/pressure of evaporator water inlet is higher than CO40 setpoint for the CO42 time delay.
Reset	<ul style="list-style-type: none"> ▪ If the water temperature is lower than CO39 –CO41 (differential) ▪ Da funzione unloading inserita dopo il tempo impostato Par. CO43
Restart	Automatic
Icon	Blinkin g 
Action	Alarm relay + buzzer OFF

41.14 ALTi: LOW AIR AMBIENT TEMPERATURE (AIR / AIR UNIT ONLY)

Label o the display	ALti (low temperature value of the evaporator air inlet)
Origin	Chiller mode: CF01=0 and evaporator inlet NTC probe lower than AL26 for AL28 seconds. Heat pump: CF01=0 and evaporator inlet NTC probe lower than lower than AL33 for AL36 seconds In stand-by or remote OFF: the evaporator inlet NTC probe lower than the lowest value compared between AL28 and AL36.
Reset	Chiller: evaporator inlet NTC probe higher than AL26 + AL27(differential). Heat pump: evaporator inlet NTC probe higher than AL33 + AL34 (differential). n stand-by or remote OFF: the evaporator inlet NTC probe higher than AL26+AL27 or AL33+AL34.
Restart	Automatic
Icon	Blinking 
Action	Alarm Relay + and buzzer on

41.15 AEP1 - AEP2 EVAPORATOR PUMPS / SUPPLY FAN MAINTENANCE REQUEST

Label description	AEP1 (Main water pump) AEP2 (Support water pump)
Activation	Load running hours > counter setpoint for that load
Reset	Running hour reset (Hour label in Menu function)
Restart	Manual
Icon	 blinking
Actions	Alarm relay and buzzer activated
REGULATIONS	
Actions	Only signalling
Loads	Not modified

The parameters CO34 / CO35 define the hour set counters for the condenser water pump / Support water pump. They establish the load running hours limit of the pump/s or the supply fan to give a maintenance signalling. If one of these parameters is equal to 0 the maintenance signalling of that load is disabled but the running hours counter remains active.

41.16 ACP1 - ACP12 CONDENSER PUMPS MAINTENANCE REQUEST

Label description	ACP1 (main water pump) ACP2 (support water pump)
Activation	Load running hours > counter setpoint for that load
Reset	Running hour reset (Hour label in Menu function)
Restart	Manual
Icon	 blinking
Actions	Alarm relay and buzzer activated
REGULATION	
Actions	Only signalling
Loads	Not modified

41.17 B1HP - B2HP HIGH PRESSURE SWITCH CIRCUIT 1 AND 2

Label on display	b1HP (high pressure switch circuit #1) b2HP (high pressure switch circuit #2)
Reason	The unit is running and the digital input of the high pressure switch is active
Reset	Digital input not active
Restart	Manual (Reset procedure in Menu function)
Icon	blinking 
Action	Alarm Relay + and buzzer on
Regulation	
Condensing fan	Maximum speed for 60 seconds

41.18 B1LP - B2LP LOW TEMPERATURE / LOW CONDENSING PRESSURE OF THE CIRCUIT

Label o the display	b1IP (low pressure digital input of the circuit 1) b2IP (low pressure digital input of the circuit 2)
Origin	When the condensing probe value is lower than AL03 setpoint if: <ul style="list-style-type: none"> In chiller or heat pump Stand-by o remote OFF when AL08 = 1 In defrost when AL06=1 The alarm is not signalled if: <ul style="list-style-type: none"> In defrost ,for the time AL07, when the 4-way valve is turned on. For the time set in AL01 after turning on the compressor.
Reset	When the condensing probe temperature is higher than AL03 + AL04 (differential)
Restart	Automatic– Manual after AL05 events per hour (Reset procedure in Menu function).
Icon	Blinking 
Action	Alarm Relay + and buzzer on

41.19 B1AC - B2AC - B1Ac - B2Ac ANTIFREEZE ALARM / LOW OUTLET TEMPERATURE (AIR / AIR UNIT IN CHILLER MODE)

Label o the display	b1AC (anti-freeze alarm of the circuit #1 in chiller) b2AC (anti-freeze alarm of the circuit #2 in chiller) b1Ac (anti-freeze alarm signalling of the circuit #1 in chiller) b2Ac (anti-freeze alarm signalling of the circuit #2 in chiller) Both the labels are displayed when the alarm is coming from the evaporator inlet probe or evaporator common outlet probe or when there is only one digital input configured.
Origin	Normal conditions, stand-by, remote OFF: when the anti-freeze probe value is lower than AL26 for AL28 seconds. With the anti-freeze digital input is active.
Reset	When the anti-freeze probe value is higher than A26+ AL27(differential) With the anti-freeze digital input is active.
Restart	Automatic – Manual after AL29 events per hours (Reset procedure in Menu function).
Icon	Blinking 
Action	If AL30=0 only the compressors are turned off and than display shows b1Ac b2Ac , the buzzer and the alarm relay are not activated. If AL30=0 only the compressors are turned off and than display shows b1Ac b2Ac , the buzzer and the alarm relay are activated. If the alarm comes from the digital input also the anti-freeze heaters are turned on.

41.20 B1AH - B2AH ANTI-FREEZE ALARM / LOW OUTLET AIR TEMPERAURE(AIR/AIR UNIT ONLY) ON HEAT PUMP MODE

Label o the display	b1AH (anti-freeze alarm of the circuit #1 in heat pump) b2AH (anti-freeze alarm of the circuit #2 in heat pump) b1Ah (anti-freeze alarm signalling of the circuit #1 in heat pump) b2Ah (anti-freeze alarm signalling of the circuit #2 in heat pump) Both the labels are displayed when the alarm is coming from the evaporator inlet probe or evaporator common outlet probe or when there is only one digital input configured.
Origin	Normal conditions, stand-by, remote OFF: when the anti-freeze probe value is lower than AL33 for AL36 seconds. With the anti-freeze digital input is active.
Reset	When the anti-freeze probe value is higher than AL33 + AL34(differenziale). With digital input ont active
Restart	Automatic – Manual after AL37 events per hour (Reset procedure in Menu function).
Icon	Blinking 
Action	If AL38=0 only the compressors are turned off and than display shows b1Ah - b2Ah , the buzzer and the alarm relay are not activated. If AL38=1 only the compressors are turned off and than display shows b1AH - b2AH , the buzzer and the alarm relay are activated. If the alarm comes from the digital input also the anti-freeze heaters are turned on.

Attention

Par. **AL35** anti-freeze alarm delay (low outlet air temperature air/air unit) when the unit starts in heat pump mode.

In stand-by or remote OFF: there is an anti-freeze alarm and the time delay in AL35<>0, if the unit is manually turned on in heat pump from keyboard or remote input, the alarm is reset so the unit can start at least for the time set in AL35 in order to heat the water or the air. After the AL35 delay if the anti-freeze probe is still lower than AL33 setpoint for AL36 seconds the unit is locked again with an anti-freeze alarm.

41.21 B1HP - B2HP HIGH PRESSURE / CONDENSING HIGH TEMPERATURE OF THE CIRCUIT

Label o the display	b1hP (high pressure digital input of the circuit #1) b2hP (high pressure digital input of the circuit #2)
Origin	In chiller or heat pump, if the condensing probe is higher than AL09 setpoint.
Reset	If the condensing probe value is lower than AL09 –AL10 (differential)
Restart	Manual (Reset procedure in Menu function).
Icon	Blinking 
Action	Alarm Relay + and buzzer on

41.22 B1LP - B2LP LOW PRESSURE SWITCH CIRCUIT #1 OR 2

Label o the display	b1LP (low pressure switch circuit #1) b2LP (low pressure switch circuit #2)
Origin	<ul style="list-style-type: none"> • With the digital input is active • If AL08=1, also in stand-by or remote OFF, when the low pressure switch input is active. • In defrost if AL06=1 when the compressor low pressure switch input is active. The alarm is not signalled if : <ul style="list-style-type: none"> • In defrost for the time AL07 when the 4-way valve is activated. • During the AL01 delay after turning on the compressor.
Reset	Digital input not active
Restart	Automatic - Manual after AL02 events per hour (Reset procedure in Menu function)
Icon	Blinking 
Action	Alarm Relay + and buzzer on

41.23 B1IP - B2LP LOW EVAPORATING PRESSURE OF THE CIRCUIT (WITH PRESSURE TRANSDUCERS ONLY)

Label o the display	b1IP (low evaporator pressure from analogue input #1) b2IP (low evaporator pressure from analogue input #2)
----------------------------	--

Origin	The alarm is activated when at least one of the probes , configured as evaporating control, is lower than AL03 setpoint if: <ul style="list-style-type: none"> • In chiller or heat pump mode; • Stand-by or remote OFF when AL08 = 1 • In defrost when AL06=1 The alarm is not signalled if: <ul style="list-style-type: none"> • In defrost ,for the time AL07, when the 4-way valve is turned on. • For the time set in AL01 after turning on the compressor.
Reset	When the condensing probe temperature is higher than AL03 + AL04 (differential)
Restart	Automatic– Manual after AL05 events per hour (Reset procedure in Menu function).
Icon	Blinking 
Action	Alarm Relay + and buzzer on

ATTENTION When the pressure transducers are configured the low pressure alarms are related only to transducer values.

41.24 B1tF- B2tF CONDENSER FAN OVERLOAD ALARM

Label o the display	b1tF (Condenser fan overload alarm of the circuit #1) b2tF (Condenser fan overload alarm of the circuit #2)
Origin	When the digital input is active
Reset	When the digital input is not active
Restart	Manual (reset from the function menu)
Icon	Blinking 
Action	Alarm relay + buzzer ON

41.25 C1HP - C2HP - C3HP - C4HP - C5HP - C6HP COMPRESSOR HIGH PRESSURE ALARMS

Label o the display	C1HP (compressor high pressure alarm 1) – ... C6HP (compressor high pressure alarm 6)
Origin	The unit is running and the digital input of the compressor high pressure switch is active
Reset	Digital input not active
Restart	Manual (Reset procedure in Menu function)
Icon	blinking 
Action	Alarm Relay + and buzzer on

41.26 C1oP - C2oP - C3oP - C4oP - C5oP - C6oP - PRESSURE SWITCH ALARM / COMPRESSOR OIL

Label o the display	C1oP (Compressor pressure switch #1) ... C6oP (Compressor pressure switch #6)
Origin	The alarm is not signalled: during the AL01 delay after turning on the compressor, during the AL12 delay that starts after the AL11 delay when the unit is properly running
Reset	Digital input not active
Restart	Automatic - Manual after AL013 events per hour (Reset procedure in Menu function)
Icon	Blinking 
Action	Alarm Relay + and buzzer on

OIL ALARM FROM PRESSURESTAT SWITCH OR OIL LEVEL SWITCH (screw)

Occasionally it is possible to find both the safety systems, the delay, the active input duration and the number of events per hour allow to set-up both the protections.

Par. **AL11** Oil alarm delay after on compressor.

It allows to set a time delay before signalling the oil or the oil level switch alarms after the on compressor.

Par. **AL12** Duration of the pressure switch / oil level switch in normal operating conditions.

Duration of the oil level switch activation during normal running condition.

It allows to set the time delay before signalling the alarm. **AL11** defines the delay counting, it helps to override the low pressure or the low oil level determined, for example, by a new partialization step of the compressor itself.

Par. **AL13** Maximum number of alarm events per hour.

It determines the maximum number of alarm events before switching the restart from automatic to manual.

41.27 C1dT - C2dT - C3dT - C4dT - C5dT - C6dT HIGH COMPRESSOR DISCHARGE TEMPERATURE ALARM

Label o the display	C1dt (High discharge temperature of the compressor #1) ... C6dt (High discharge temperature of the compressor #6)
----------------------------	---

Origin	The compressor discharge temperature is higher than AL39 setpoint. ATTENTION The display resolution is 0.1°C until the read-out is 99.9, over 100°C it is 1°C.
Reset	If the probe value of the high discharge temperature is lower than "AL39 - AL40 (differential)"
Restart	Automatic. Manual when there are AL41 per hour (Reset procedure in Menu function).
Icon	Blinking 
Action	Alarm Relay + and buzzer on

41.28 C1TR - C2TR - C3TR - C4TR - C5TR - C6TR COMPRESSOR OVERLOAD ALARM

Label o the display	C1tr (Compressor #1 overload alarm) -... C6tr (Compressor #1 overload alarm 6)
Origin	With active digital input The alarm is not detected within the AL19 time delay after the on compressor
Reset	When the digital input is not active
Restart	Manual after AL20 events/hour, to reset the alarm enter the function menu under cOtr.
Icon	Blinking 
Action	Alarm relay + buzzer ON
Compressor involved	If AL47=0 or 1: OFF
Compressor not involved	If AL47=0: it follows its regulation. If AL47=1: OFF

ATTENTION

The parameter AL47 determines the functioning of the overload alarm of the compressors.

If AL47 = 0 single compressor locked when its digital input protection is active, on the display the corresponding alarm message.

If AL47 = 1 all the circuit of the compressor is locked when one digital input protection is active, on the display the corresponding alarm message.

41.29 B1DF – B2DF DEFROST ALARM

Label o the display	b1dF (Defrost alarm of the circuit #1) b2dF (Defrost alarm of the circuit #2)
Origin	Only in defrost if DF01 = 1,3 (defrost en temperature/pressure or external contact): when the defrost ends after the DF05 timeout.
Reset	<ul style="list-style-type: none"> ▪ Stand - by or remote ON-OFF. ▪ Next defrost ends for temperature/pressure.
Restart	Automatic if next defrost ends for temperature/pressure, otherwise manual.
Icon	Blinking 
Action	Alarm relay + buzzer OFF

41.30 B1CU – B2CU UNLOADING DISABLED FROM HIGH CONDENSING TEMPERATURE / PRESSURE IN CHILLER

Label o the display	b1CU (unloading high temperature from condenser of the circuit # 1) b2CU (unloading high temperature from condenser of the circuit # 2)
Origin	When the temperature/pressure of condenser probe control is higher then CO44
Reset	<ul style="list-style-type: none"> ▪ When the temperature/pressure of condenser probe is lower than CO44 –CO45 (differential) ▪ After unloading is activated and after Par. CO47
Restart	Automatic
Icon	Blinkin 
Action	Alarm relay + buzzer OFF

41.31 B1CU – B2CU: UNLOADING FROM LOW CONDENSING TEMPERATURE / PRESSURE IN HEAT PUMP

Label o the display	b1CU (unloading message from condenser #1) b2CU (unloading message from condenser #2)
Origin	During normal running condition when the temperature/pressure of evaporator/condenser probe is lower than < CO46 setpoint
Reset	<ul style="list-style-type: none"> ▪ when the temperature/pressure of evaporator/condenser probe value is higher than CO46 + CO47 ▪ After unloading is activated and after Par. CO48
Restart	Automatic
Icon	Blinking 
Action	Alarm relay + buzzer OFF

41.32 B1RC – B2RC RECOVERY DISABLED FROM HIGH CONDENSING TEMPERATURE/PRESSURE IN CHILLER

Label on the display	b1rC (recovery disabled message from circuit #1) b2rC (recovery disabled message from circuit #2)
Origin	In normal running condition when the temperature/pressure probe value is higher than the set rC06
Reset	<ul style="list-style-type: none"> ▪ When the temperature/pressure probe value is lower than the rC06 –rC07(differential) ▪ Unloading start after the time delay Par. rC08
Restart	Automatic
Icona	Blinking 
Action	Alarm relay + buzzer OFF

41.33 B1PH - B2PH: PUMP DOWN STOP ALARM FROM PRESSURE SWITCH / LOW PRESSURE SWITCH

Label on the display	b1PH (Pump down stop alarm of the circuit 1) b2PH (Pump down stop alarm of the circuit 2)
Origin	Pressure switch: if CO36 = 1,2,3,4 and ID not active, the pump down stops because of the timeout CO39. Transducer: if CO36 = 1,2,3,4 and the set CO37 is not reached: the pump stops because of the timeout CO39.
Reset	From thermoregulation start-up and ID not active From thermoregulation start-up with evaporating pressure higher than CO37 + CO38 (differential)
Restart	Automatic – Manual and logged after AL21 events per hour (reset procedure in function menu).
Icona	Blinking 
Action	Alarm relay + buzzer ON when it becomes manual

41.34 B1PL - B2PL ALARM DURING THE PUMP DOWN START-UP FROM PUMP DOWN PRESSURE SWITCH / LOW PRESSURE TRANSDUCER

Label o the display	b1PL (pump down alarm in start-up of circuit #1) b2PL (pump down alarm in start-up of circuit #2)
Origin	Pump down pressure switch : CO36 = 1,2,3,4 and compressors start-up and digital input not active for the time set in CO39 Pump down transducer: CO36 = 1,2,3,4, compressors start-up and the set CO37 is not reached in the interval time CO39.
Reset	From thermoregulation start-up and ID not active From thermoregulation start-up with evaporating pressure higher than CO37 + CO38 (differential)
Restart	Automatic - Manual and logged after AL21 events per hour if AL23=1 (reset procedure in function menu). If AL23 = 0 it is automatic and not logged.
Icona	Blinking 
Action	Alarm relay + buzzer ON when it becomes manual

41.35 C1Mn - C2Mn - C3Mn - C4Mn - C5Mn - C6Mn COMPRESSOR MAINTENANCE

Label o the display	C1Mn (Compressor #1 maintenance) –... C6Mn (Compressor #6 maintenance)
Origin	Compressor running hours > Hour counter setpoint
Reset	Hour reset in function menu
Restart	Manual
Icona	Blinking 
Action	Alarm relay + buzzer ON
Regulation	
Action	Only display warning messages
Loads	Not changed

41.36 AEP1 - AEP2 PUMP/ SUPPLY FAN MAINTENANCE

Label o the display	AEP1 (Evaporator #1 pump maintenance) AEP2 (Evaporator #2 pump maintenance)
---------------------	--

Origin	Pump/supply fan running hours > Hour counter setpoint
Reset	Hour reset in function menu
Restart	Manual
Icona	Blinking 
Action	Alarm relay + buzzer ON
Regulation	
Action	Only display warning messages
Loads	Not changed

41.37 ACP1 - ACP1 CONDENSER PUMP MINTENANCE

Label o the display	ACP1 (Condenser #1 pump maintenance) ACP1 (Condenser #2 pump maintenance)
Origin	Pump running hours > Hour counter setpoint
Reset	Hour reset in function menu
Restart	Manual
Icona	Blinking 
Action	Alarm relay + buzzer ON
Regulation	
Action	Only display warning messages
Loads	Not changed

41.38 ALARM RELAY AND BUZZER

Alarm relay / buzzer outputs

Origin	Alarms still active Alarms not reset
Reset relay alarm	Whitout alarms In stand- by or remote ON-O FF if AL42 = 1
Buzzer silencing	By pushing one of the key of the front panel

The alarm relay is enabled only by configuring the corresponding output resource.

41.39 KEYBOARD ALARM

Alarm code	keyboard Alarm description
noL	No data communication between the keyboard and the regulator.
Atr1	keyboard n° 1 set up but not connected to regulator
Atr2	keyboard n° 2 set up but not connected to regulator

42 AUTOMATIC TO MANUAL ALARM PROCEDURE

NUMBER OF EVENTS PER HOUR

Each hour counting is divided in 16 intervals, each made of 3600 / 16 = 225 seconds (3 minuts and 45 seconds).

1°Int	2°Int	3°Int	4°Int	5°Int	6°Int	7°Int	8°Int	9°Int	10°Int	11°Int	12°Int	13°Int	14°Int	15°Int	16°Int
-------	-------	-------	-------	-------	-------	-------	-------	-------	--------	--------	--------	--------	--------	--------	--------

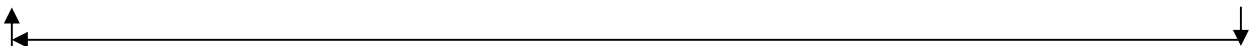

After the unit start-up, each interval is marked as "not active". During the interval counting, for 255seconds, if at least an alarm event appears, the interval itself is marked "Active".

Starting from the first interval the instrument calculates the 16 intervals and, at the end, it restats overwriting from the first.

In this way the last hour is always monitored and counted the active intervals. when the number of active intervals reaches the thresold set with the corresponding parameter the alarm becomes manual.

By setting the thresold (parameter)=0 the alarm is manual from its first activation while if the thresold=16 the alarm is always automatic (In this case, to change in manual, the thresold should be 17).

43 TABLE OF THE OUTPUT STATUS IN ALARM CONDITION

The alarm codes are made of letters and numbers to define the different typologies:

43.1 ALARM: "A" TYPE AND CORRESPONDING OUTPUT OFF

Alarm Code	Alarm description	Compressor	Anti freeze heaters Boiler	Support heaters	Evap. Pump. Supply fan	Condens er Pump	Ventilaz. cond. Cir1 Cir2	Auxiliary relay
AP1	Probe PB1 Alarm	Yes	Yes (1)	Yes			Yes	Yes (2)
AP2	Probe PB2 Alarm	Yes	Yes (1)	Yes			Yes	Yes (2)
AP3	Probe PB3 Alarm	Yes	Yes (1)	Yes			Yes	Yes (2)
AP4	Probe PB4 Alarm	Yes	Yes (1)	Yes			Yes	Yes (2)
AP5	Probe PB5 Alarm	Yes	Yes (1)	Yes			Yes	Yes (2)
AP6	Probe PB6 Alarm	Yes	Yes (1)	Yes			Yes	Yes (2)
AP7	Probe PB7 Alarm	Yes	Yes (1)	Yes			Yes	Yes (2)
AP8	Probe PB8 Alarm	Yes	Yes (1)	Yes			Yes	Yes (2)
AP9	Probe PB9 Alarm	Yes	Yes (1)	Yes			Yes	Yes (2)
AP10	Probe PB10 Alarm	Yes	Yes (1)	Yes			Yes	Yes (2)
ALTI	Low air temperature of the evaporator inlet (air / air unit) /Alarm							
AEFL	Evaporator flow alarm	Yes	Yes (boiler)		Yes (3)	Yes (3)	Yes	
ACFL	Condenser flow alarm	Yes				Yes (3)	Yes	
AISF	Fan supply overload alarm	Yes		Yes	Yes		Yes	
AEUJ	Unloading signalling from evaporator							
AIE1	Water pump overload alarm evaporator 1	Yes (4)	Yes (boiler) (5)		Yes		Yes	
AIE2	Water pump overload alarm support evaporator 2	Yes (4)	Yes (boiler) (5)		Yes		Yes	
ATC1	Water pump overload alarm condenser 1	Yes (4)				Yes	Yes	
ATC2	Water pump overload alarm support condenser 2	Yes (4)				Yes	Yes	
AEP1	Water pump maintenance evaporator 1							
AEP2	Water pump maintenance support evaporator 2							
ACP1	Water pump maintenance condenser 1							
ACP2	Water pump maintenance support condenser 2							
ArtC	Clock alarm							
ArtF	clock failure							
ALOC	Generic alarm with unit stopped	Yes			Yes	Yes	Yes	Yes
AEE	Eeprom alarm	Yes			Yes	Yes	Yes	Yes
ACF1	Configuration alarm	Yes			Yes	Yes	Yes	Yes
ACF2	Configuration alarm	Yes			Yes	Yes	Yes	Yes
ACF3	Configuration alarm	Yes			Yes	Yes	Yes	Yes
ACF4	Configuration alarm	Yes			Yes	Yes	Yes	Yes
ACF5	Configuration alarm	Yes			Yes	Yes	Yes	Yes
ACF6	Configuration alarm	Yes			Yes	Yes	Yes	Yes
ACF7	Configuration alarm	Yes			Yes	Yes	Yes	Yes
ACF8	Configuration alarm	Yes			Yes	Yes	Yes	Yes
ACF9	Configuration alarm	Yes			Yes	Yes	Yes	Yes

Artf	Faulty clock						
Artc	Clock error						
AEUn	Unloading signalling from high temp. of. evaporator water						
ALti	Low evaporator inlet temperature in air/air unit						
AEP1	Evaporator #1 water pump maintenance						
AEP2	Evaporator #2 water pump maintenance						
ACP1	Condenser #1 water pump maintenance						
ACP2	Condenser #2 water pump maintenance						

(1) = with probe configured as anti-freeze / boiler control and Ar10 = 0

(2) = with probe configured as auxiliary relay control

(3) = with manual alarm procedure

(4) = Off compressors spent with only 1 water pump configured or with 2 pumps but both in alarm from the corresponding digital inputs.

(5) = Boiler heaters off with only 1 water pump configured or with 2 pumps but both in alarm from the corresponding digital inputs (In this case the boiler heaters are on only with thermoregulation anti-freeze setpoint as evaporator protection function)

43.2 ALARM: "A" TYPE AND CORRESPONDING OUTPUT OFF

Alarm Code	Alarm description	Compressors of the circuit (n)	Compressors of the other circuit	Fan condensing of the circuit (n)	Fan condensing of the other circuit
b(n)HP	High pressure switch of the circuit (n)	Yes		Yes after 60 seconds	
b(n)LP	Low pressure switch of the circuit (n)	Yes		Yes	
b(n)AC	Anti-freeze in chiller of the circuit (n)	Yes		Yes	
b(n)AH	Anti-freeze in heat pump of the circuit (n)	Yes		Yes	
b(n)hP	High condensing pressure of the circuit (n)	Yes		Yes after 60 seconds	
b(n)hP	High condensing pressure from NTC of the circuit (n)	Yes		Yes after 60 seconds	
b(n)LP	Low condensing pressure - (evaporating with low pressure transducer) with transducer of the circuit of the (n)	Yes		Yes	
b(n)JP	Low condensing temperature NTC circuit (n)	Yes		Yes	
b(n)tF	Fan overload circuit (n)	Yes		Yes	
b(n)PH	Pump down alarm in stop regulation of the circuit (n)	Yes		Yes	
b(n)PL	Pump down in regulation start-up of the circuit (n)	Yes		Yes	
b(n)dF	Bad defrost circuit (n)				
b(n)Cu	Unloading from condenser high temp/press of the circuit (n)				
b(n)Cu	Unloading from evaporator low temp/press of the circuit (n)	Yes		Yes	
b(n)rC	Recovery function disabled in circuit (n)				
b(n)ds	Circuit (n) disabled from keyboard	Yes		Yes	
b(n)Ac	Anti-freeze circuit (n) message in chiller				
b(n)Ah	Anti-freeze circuit (n) message in heat pump				

(n) identifies the circuit 1 or 2

43.3 ALARM: "A" TYPE AND CORRESPONDING COMPRESSOR OUTPUT OFF

Alarm Code	Alarm description	Compressor (n)	Compressors not involved
C(n)HP	Compressor(n) high pressure switch	Yes	
C(n)OP	Compressor(n) oil pressure switch / Oil level switch	Yes	
C(n)tr	Compressor(n) overload	Yes	
C(n)dt	Compressor high discharge temperature	Yes	
C(n)dS	Compressor (n) disabled from keyboard	Yes	
C(n)Min	Compressor(n) maintenance		

(n) identifies the compressor 1, 2, 3, 4, 5, 6

44 BLACK-OUT

After the black-out is restored:

1. The instrument resumes the same operating mode lost after the supply failure.
2. If active, the defrost is aborted.
3. All the timers and time parameters are reloaded.
4. The manual alarm is not reset.

45 INSTALLING AND MOUNTING

45.1 PANEL CUT-OUT

The instrument must be mounted on vertical panel, with panel cut-out 150x31mm, and screwed 2 screws $\varnothing 3 \times 2$ mm, in between distance 165mm. The IP65 can be reached with the gasket RG-L (opzionale).

The ambient working temperature range should be between 0+60°C. Avoid locations subject to heavy vibration, corrosive gases or excessive dirt. The same applies to the probes. Ensure ventilation around the instrument.

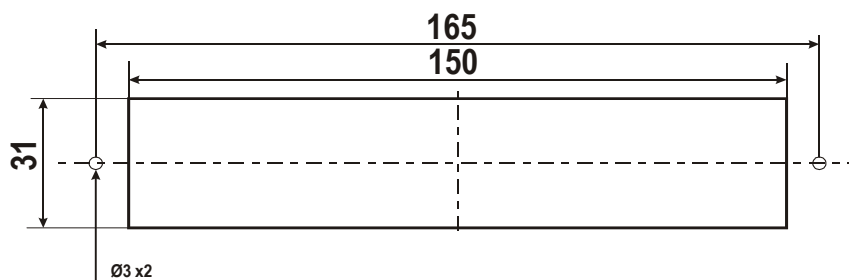

45.2 PLEXIGLASS PROTECTION BOTTOM OPEN

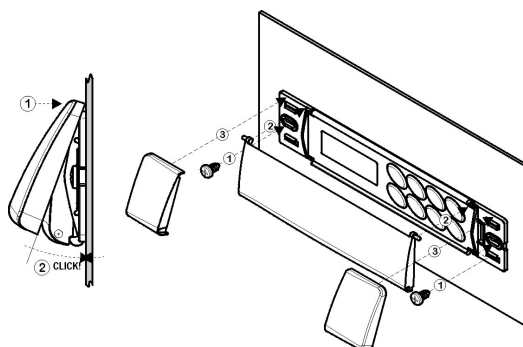

45.3 PLEXIGLASS PROTECTION TOP OPEN

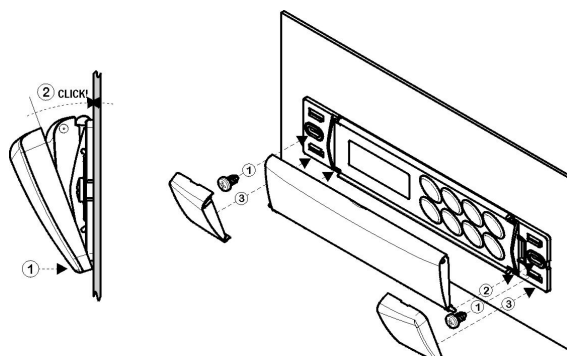

45.4 METAL FRONT FRAME

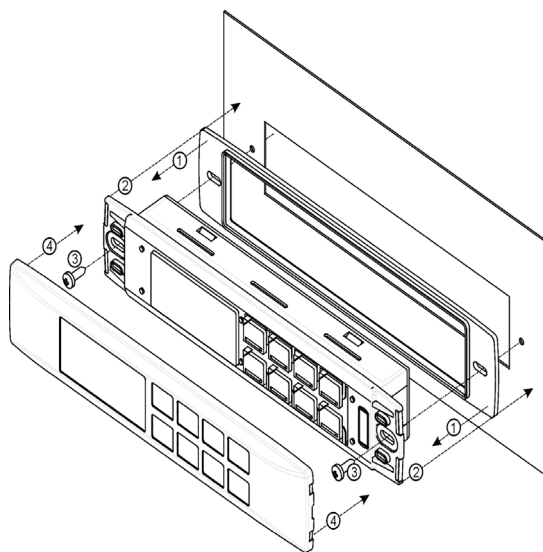

45.5 VERTICAL BOARDS Vi620 – Vi820 PANEL CUT-OUT

The remote terminals are for panel mounting, panel cut-out 72x56 mm, and screwed with two screws. The IP65 can be reached with the gasket RGW-V (optional).

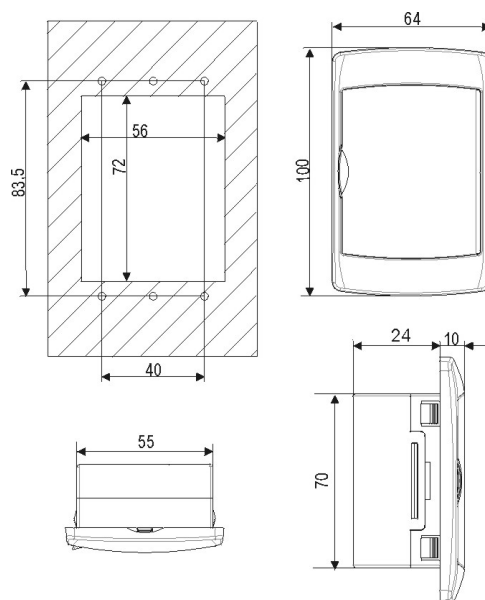

WALL MOUNTING: use the vertical V-KIT (black, white and grey) as described in the following scheme:

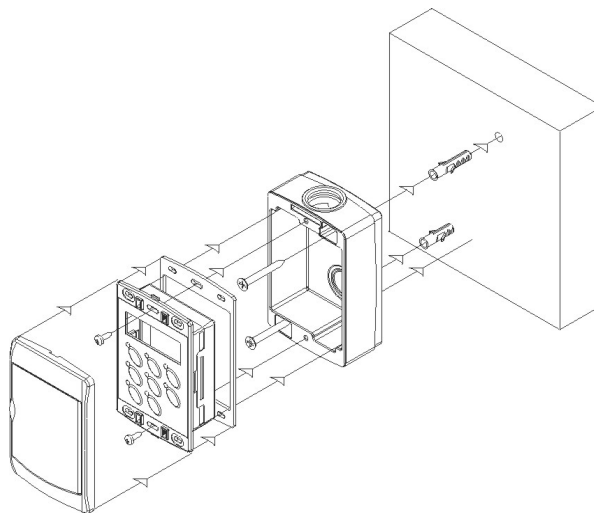

46 ELECTRICAL CONNECTIONS

The instrument is provided with:

- 3 removable terminal blocks MOLEX with 0.5 mm² wires: 16 / 8 / 22 ways for digital / analogue inputs and modulating outputs.
- 4 removable screw terminal block STELVIO for 2.5 mm² wires connection: 3 / 4 / 5 / 6 ways for the relay outputs.
- 5 ways connector for TTL RS485 interface outputs.
- 2 ways connector for remote panels to be connected with the cable **CAB/CJ30**. The remote panels have two terminals for 2.5 mm² wires.
- The **LW30 KIT** is the complete kit with MOLEX + 3 mt wires already connected and the STELVIO terminals.
- Check the connections and the line voltage before turning on the power supply.
- Keep low voltage cables, such as analogue/digital inputs/outputs and probes, away from power cables and terminals.
- Respect the maximum load current of each relay output, in case of power loads use filtered contactors.

47 ACCESSORIES

47.1 MONOPHASE FAN CONTROL: 230VAC AND CUT PHASE CONTROL

Models	XV05PK	XV10PK	XV22PK
Power	500W	1000W	2200W
Ampere	2A	4A	9.5A
Scheme	1	1	1

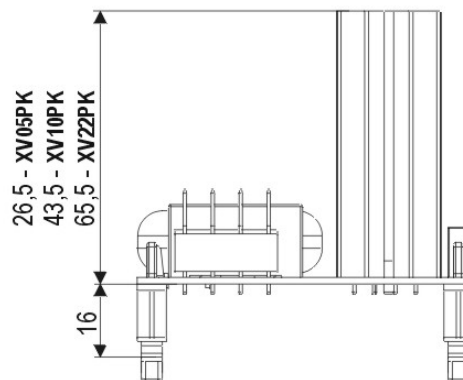
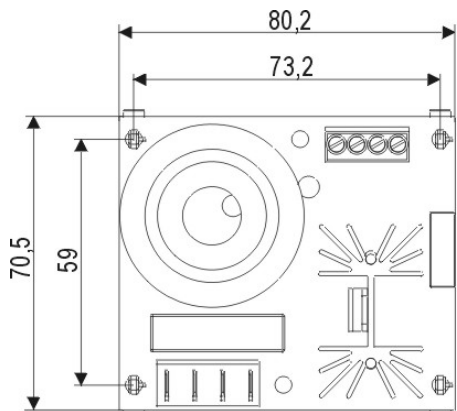

(Scheme 1)

Power supply			
230Vac	Input		
0 - 230Vac	output		
-10 - 65°C	Operating temperature		
Naylon supports			
D	15mm		
Height			
Model	XV05PK	XV10PK	XW22PK
Y	25mm	42mm	64mm
Connections			
A 1(+), 2(-)	PWM input control		
B 3(+), 4(-)	PWM output repetition signal		
F	Phase		
N	Neutral		
5 - 6	Fan output		
Terminals 3 and 4 allows to connect another board in parallel to control two separate fans with the same input control.			
Terminals 1 / 2 / 3 / 4 are for screw for a 2.5mm wire			
Terminals 5 / 6 / F / N are 6,3mm faston			

47.2 INVERTER: MICROFAN 380VAC UP TO 4KW OR 8KW

Dixell models XV340GS, power up to 8KW (scheme 2)

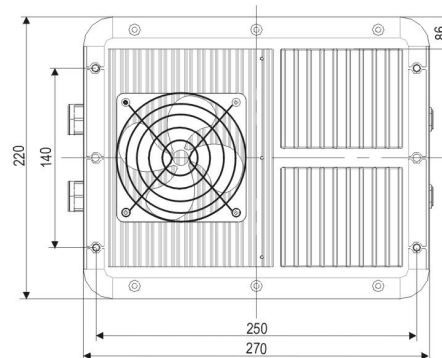
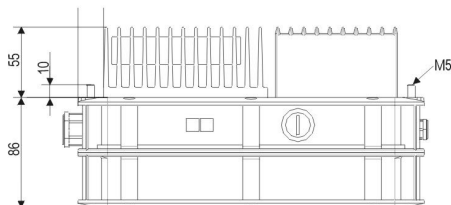
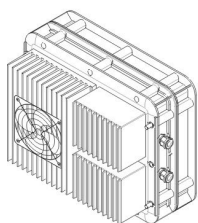

(Scheme 2)

47.3 TRANSFORMER

The standard power supply is 12 volt AC/DC or 24 volt AC/DC (optional)

The TF10 transformer models: 230/12 Vac , 230 /24 Vac, 110 / 12 Vac, 24 / 12 Vac

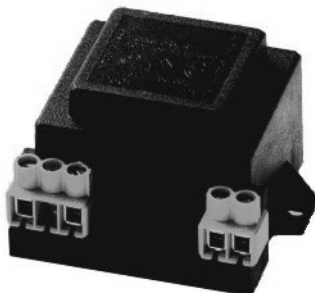

48 TECHNICAL DATA

Housing: self extinguishing ABS.

Case: frontal 185x38 mm; depth 70mm (L format)

Mounting: panel mounting in a 150x31mm panel cut-out

Frontal protection: IP65 with gasket

Display:

Top Display 3 digits with d.p.

Bottom Display 4 digits with d.p.

Connections: Removable screw terminal block 2,5mm².

Power supply:

12Vac/dc, -10%÷+15%

24 Vac/dc±10%. 50/60 HZ (opzionale)

Power absorption: 10VA max.

Inputs: 10 NTC or 6 NTC + 4 (4 ÷ 20ma – 0 ÷ 5Volt)

Digital inputs: # 18 (free voltage)

Relay outputs: 14 SPDT 5(2) A, 250Vac.

Data storing: on the non-volatile memory (EEPROM).

Operating temperature: 0÷60 °C.

Storage temperature: -30÷85 °C.

Relative humidity: 20,85% (no condensing)

Measuring range: - 30÷70 °C (- 22 ÷ 158 °F) NTC / 0÷150 °C (0÷302 °F) PTC or 0÷ 50 bar (0÷725 psi)

Resolution: 0,1 °C or 1 °F (selectable)

Accuracy of the controller at 25°C: ±0,7 °C ±1 digit