



iCHiLL 100CX

Instruction Manual



INDEX

1.	General Advices	2
2.	User Interface	3
3.	Remote Keyboard VICX610	4
4.	Display visualization	5
5.	Silencing the Buzzer	6
6.	First Installing	6
7.	How to Set the Clock RTC	6
8.	“ Hot Key” Programming	6
9.	Parameters Programming	6
10.	How to Change the Password	7
11.	Start / Stop Chiller or Heat Pump	7
12.	Stand- By Function	7
13.	“menu” Function	7
14.	Keyboard Functions	8
15.	Remote ON/OFF	9
16.	How to Disable a Compressor	9
17.	Dynamic Set Point	9
18.	Energy Saving	9
19.	Compressor regulation	10
20.	Condenser Fan Regulation	11
21.	Hot Start Function	11
22.	Automatic Change - Over	12
23.	Defrost Function	12
24.	Function for units without water storage tank	13
25.	Geothermal chiller function	13
26.	Unloading function	14
27.	Boiler Function	14
28.	Modulating water pump	16
29.	Maintenance Function	16
30.	Black Out	16
31.	Alarm Code and Events	17
32.	Output Lock for Alarm Event Table	23
33.	Parameter description	25
34.	Parameter Table	36
35.	Installing and Mounting	52
36.	Electrical Wiring	54
37.	Connecting Diagram	55
38.	Technical Data	58

1. GENERAL ADVICES



- Please read this manual before using
- This manual is part of the product and should be kept near the instrument for easy and quick reference.
- The instrument shall not be used for purposes different from those described hereunder. It cannot be used as a safety device.
- Check the application limits before proceeding.

1.1 Safety Precaution

- Check the supply voltage is correct before connecting the instrument.
- Do not expose to water or moisture: use the controller only within the operating limits avoiding sudden temperature changes with high atmospheric humidity to prevent formation of condensation
- Warning: disconnect all electrical connections before any kind of maintenance.
- Fit the probe where it is not accessible by the End User. The instrument must not be opened.
- In case of failure or faulty operation send the instrument back to the distributor or to "Dixell s.r.l." (see address) with a detailed description of the fault.
- Consider the maximum current which can be applied to each relay (see Technical Data).
- Ensure that the wires for probes, loads and the power supply are separated and far enough from each other, without crossing or intertwining.
- In case of applications in industrial environments, the use of mains filters (our mod. FT1) in parallel with inductive loads could be useful.

2. USER INTERFACE



2.1 Display

Upper digits (red color): configurable, see parameter CF36 (PB1, PB2, PB4, Set-point (parameter value)*, working set-point (real set-point modified from dynamic set-point, Energy saving or function for units without water storage tank), Hysteresis, Machine status **))

Lower digits (yellow color): configurable, see parameter CF43 (PB1, PB2, PB3, PB4, Set-point (parameter value)*, working set-point (real set-point modified from dynamic set-point, Energy saving or function for units without water storage tank), Hysteresis, RTC, Machine status **)).

*the display visualizes chiller set point when the unit is on and in chiller mode, heating set point when the unit is on and in heat pump mode, and OFF when the unit is in standby.

**the display visualizes OnC when the unit is on and in chiller mode, OnH when the unit is on and in heat pump mode, and OFF when the unit is in standby.





2.2 Icons of the Display

Icon	Meaning
°C -°F bar-PSI	ON when the display visualizes a temperature or a pressure
	On when the display visualizes the RTC, working hours, etc.
	On flashing in case of alarm
Vset	On if the Energy Saving, dynamic set-point or function for units without water storage tank are active. OFF if a function above is enabled but not active.
menu	On during menù visualization
	On if heaters are activated (antifreeze heaters or/and boiler)



	On flashing during defrost delay time. On during defrost
Flow	On flashing if water flow switch is activated. When the pump is OFF, the led is on flashing to indicate the correct status of the digital input
	On if at least one water pump is on
	On if evaporator fans are activated
	On if a compressor is on. On flashing during the delay time for compressor activation.
	On if open collector output is active
	On if the controller is on in Heat or Cool mode
LP HP	On in case of Low pressure alarm or High pressure alarm

2.3 Keys

	<ol style="list-style-type: none"> 1. Push to enter in the Menu 2. Push and hold (about 3 seconds) to set the clock
	<ol style="list-style-type: none"> 1. Push to visualize the set point. 2. Push and release 2 times: 1st time is visualized the setpoint (the value of the parameter), 2nd time is visualized the real setpoint (when Energy saving, Dynamic setpoint or function for units without water storage tank are enabled) 3. Push and hold to modify the setpoint 4. Push during parameter programming: <ul style="list-style-type: none"> - to enter in parameter modification - to confirm the changes of the parameter 5. Menù AlRM: push to reset the alarms

	<ol style="list-style-type: none"> 1. Push and release to visualize all the probes configured 2. In programming mode it scrolls the parameter list 3. In programming mode increases the value of the parameters.
	<ol style="list-style-type: none"> 1. Push and release to visualize all the probes configured 2. In programming mode it scrolls the parameter list 3. In programming mode decreases the value of the parameters
	<ol style="list-style-type: none"> 1. Push and hold to switch on/off the machine (chiller or heat pump depending from CF31 parameter)
	<ol style="list-style-type: none"> 1. Push and hold to switch on/off the machine (chiller or heat pump depending from CF31 parameter)

2.4 Key Combination

	<p>Push and hold to enter on the parameters programming</p>
	<ol style="list-style-type: none"> 1. Push to exit to the programming parameters 2. Push and hold to activate manual defrost

3. REMOTE KEYBOARD VICX610



The Ichill has to be configured to manage the remote keyboard.

Upper digits (red color): configurable by parameter CF44 (PB1, PB2, PB4, Set-point (parameter value)*, working set-point (real set-point modified from dynamic set-point, Energy saving or function for units without water storage tank), Hysteresis, Machine status **)

Lower digits (yellow color): configurable by parameter CF45 (PB1, PB2, PB3, PB4, Set-point (parameter value)*, working set-point (real set-point modified from dynamic set-point, Energy saving or function for units without water storage tank), Hysteresis, RTC, Machine status **).

*the display visualizes chiller set point when the unit is on and in chiller mode, heating set point when the unit is on and in heat pump mode, and OFF when the unit is in standby.

**the display visualizes OnC when the unit is on and in chiller mode, OnH when the unit is on and in heat pump mode, and OFF when the unit is in standby.

Note:

the Ichill 100CX is not compatible with VI610 remote keyboard.

3.1 Key Function

Concerning the meaning of the keys, refer to paragraph 2.3.

Air/Air unit: using the remote keyboard with NTC sensor on board (VICX610S model and parameter CF35 = 2), the read-out and the regulation are controlled by the NTC sensor mounted on the remote keyboard.

When there is not communication between the keyboard and the instrument the display visualizes "noL" (no link message).

4. DISPLAY VISUALIZATION



Upper digits (red color): configurable by parameter CF36 (PB1, PB2, PB4, Set-point (parameter value)*, working set-point (real set-point modified from dynamic set-point, Energy saving or function for units without water storage tank), Hysteresis, Machine status **)

Lower digits (yellow color): configurable by parameter CF43 (PB1, PB2, PB3, PB4, Set-point (parameter value)*, working set-point (real set-point modified from dynamic set-point, Energy saving or function for units without water storage tank), Hysteresis, RTC, Machine status **).

*the display visualizes chiller set point when the unit is on and in chiller mode, heating set point when the unit is on and in heat pump mode, and OFF when the unit is in standby.

**the display visualizes OnC when the unit is on and in chiller mode, OnH when the unit is on and in heat pump mode, and OFF when the unit is in standby.

4.1 Alarm visualization



When the instrument detects an alarm, the lower display shows the alarm code alternated to probe value. The alarm icon (△) is on flashing. In case of HIGH PRESSURE alarm (HP), LOW PRESSURE alarm (LP) or WATER FLOW SWITCH (Flow!), dedicated icons are on.

4.2 STD-BY visualization

It is possible to choose what visualize when the I chill is in STD-BY.

CF 46 = 0: the display visualizes the same informations configured in CF36 e CF43



CF 46 = 1: the display visualizes the label "OFF"



CF 46 = 2: the display visualizes the label "StbY"



5. SILENCING THE BUZZER

Automatically: just after the alarm condition is recovered.
Manually: push and release one of the keys; the buzzer is stopped even if the alarm is still active.

6. FIRST INSTALLING

After giving power supply to the instrument, the lower display can show "rtC" alternated to the probe value: **it is necessary to set the clock time.**
 If the probes are not connected, or they are faulty, the display shows the corresponding alarm code.
 In any case it is possible to proceed with clock setting.

7. HOW TO SET THE CLOCK RTC

1. Push "menu" key for some seconds and wait until "Hour" label appears.
2. Push "SET": the hour value starts flashing.
3. Push \blacktriangledown or \blacktriangle to change the value. Confirm by pushing "SET"; after some seconds the controller will show "Min".
4. Repeat points 2 and 3 to set other parameters:
Min: minutes (0+60)
UdAy: day of the week (**Sun** = Sunday, **Mon** = Monday, **tuE** = Tuesday, **UEd** = Wednesday, **tHu** = Thursday, **Fri** = Friday, **SAt** = Saturday).
dAy: day of the month(0+31)
MntH: Month (1+12)
yEAR: Year (00+99)

8. "HOT KEY" PROGRAMMING

8.1 Download from the Hot Key (previously programmed) to the Instrument Memory

- The controller has to be not connected to the power supply
 - Insert the Hot Key into dedicated connector
 - Connect the controller to the power supply
 - The download starts and lasts some seconds.
- During this phase the whole regulation is locked and the "dOL" message is flashing.
 "End " message will appear if the programming result is good, after 15 sec. the regulation automatically restarts
 If "Err" message appears the operation has given bad result. Turn the controller off and then on again to repeat the operation or restart the normal regulation.

8.2 Upload the Parameter from the Controller to the Hot Key

- The instrument has to be connected to the power supply:
1. Insert the Hot Key
 2. Push "menu"

3. Select "UPL" function with the arrow keys
4. Push "SET" key. The Upload starts immediately. During this phase the whole regulation is locked and the "UPL" message is flashing.
 "End " message will appear if the programming result is good, after 15s the regulation automatically restarts.
 If "Err" message appears the operation has given bad result. Repeat the points 1-4 for a new Upload.

9. PARAMETERS PROGRAMMING

9.1 "Pr1" Programming Level (User Level)

How to access the "Pr1" User Level:

- 1) Push "SET" + \blacktriangledown key for some seconds; the upper display shows "ALL" (first family of parameters).
 \ast and \ast icons are flashing.
- 2) Using \blacktriangle and \blacktriangledown arrows scroll the other family labels.
- 3) Push "SET" to enter and see all the parameter belonging to that family. The display shows the first parameter label and its value.

Scroll the parameter list with \blacktriangle and \blacktriangledown arrows or modify the value as described in 9.4.

9.2 "Pr2" Programming Level (Factory Level)

"Pr2" parameters level is accessible through password:

1. Enter the "Pr1" level as described in 9.1.
2. Search parameter "Pr2"; "PAS" label appears on the upper side.
3. Push "SET": the lower display shows "Pas" and the upper display shows "0" flashing.
4. Set the password using \blacktriangle and \blacktriangledown keys.
5. Push SET key to confirm the value.

9.3 How to Move a Parameter from "Pr2" Level to "Pr1" Level

Enter the "Pr2" level and select the parameter to move; keeping pressed "SET" key, push and immediately release the \blacktriangledown key.
 The led in lower display will light to indicate the presence of the parameter in "Pr1". Then release also SET key.
 To move the parameter in "Pr2" again: keep pressed SET key and immediately release the \blacktriangledown key. The led turns off so as the parameter is not more visible in "Pr1" but just in "Pr2".

9.4 Changing a Parameter Value

1. Access to programming mode Pr1 or Pr2
2. Select the parameter to modify
3. Push "SET"

4. Modify the value with ▲ and ▼ keys
5. Push **SET** key again to confirm the new value; after some seconds next parameter will be displayed
6. Exit the programming mode: push **"SET"** and ▲ when a parameter label is displayed, or wait 15s (time-out) without pushing any keys.

NOTE: The new parameter value is also confirmed if, after changing it, no **SET** key is pressed for the time-out to exit.

ATTENTION:

CF parameters (Configuration parameters) can be modified only if the controller is in OFF (digital input) or STD-BY.

10. HOW TO CHANGE THE PASSWORD

To change the password you must know the previous value. This operation is possible only starting from **Pr2** level.

- 1) Enter the **Pr1** level
- 2) Select a family of parameters (ST, or CF, or SD,...) and push **"SET"** key
- 3) Using ▲ and ▼ keys select the parameter **"Pr2"**, then push **"SET"** key. The lower display shows **"PAS"** and the upper display shows **0** flashing
- 4) Use ▼ and ▲ keys to input the active **PASSWORD**; push **"SET"** to confirm the value and enter to **Pr2** level
- 5) Search **"Pr2"** parameter with ▼ and ▲ keys
- 6) Push **"SET"** key to enter the new value (flashing)
- 7) Insert the new password with ▲ and ▼ keys.
- 8) Push **"SET"** key to confirm it.
- 9) The upper display will flash for few seconds then, next parameter will be showed.
- 10) Exit the programming by pushing **"SET"** and ▲ together or wait the time-out.

11. START / STOP CHILLER OR HEAT PUMP

Press  key for 3 seconds:

- the unit starts or stops the Chiller cycle if the parameter **CF31 =0**
- the unit starts or stops the Heat Pump cycle if the parameter **CF31 =1**

The icon  flashes for 3 seconds when the controller is waiting to turn on/off.

To move from Chiller mode to Heat Pump mode or vice versa, it is necessary to stop the current cycle and then restart the new (Chiller → STD-BY → Heat Pump) .



Press  key for 3 seconds:

- the unit starts or stops the Heat Pump cycle if parameter **CF31 =0**
- the unit starts or stops the Chiller cycle if parameter **CF31 =1**

The icon  flashes for 3 seconds when the controller is waiting to turn on/off.

To move from Chiller mode to Heat Pump mode or vice versa, it is necessary to stop the current cycle and then restart the new (Chiller → STD-BY → Heat Pump) .

12. STAND-BY FUNCTION

When the controller is working, it is possible to switch it in std-by mode pushing  or  key.

In stand-by is possible:

- Display probes value using arrow keys.
- Display and modify the set-point.
- Enter the "menu" function

13. "MENU" FUNCTION

Access the "menu" to perform the following operations:

1. Display and reset the active alarms.
2. Display and reset working hours of compressors and water pumps
3. Display delay time between two defrost cycles
4. Upload the parameters map from the controller to the Hot Key (see 8.2).
5. Display/reset the alarm log.

During the Menu operations the "menu" icon is on.

13.1 Access to the "menu"

Push and release the **"menu"** key. The " menu" icon is on.

13.2 Exit from the "menu"

Push and release the **"menu"** key or wait the time out. The "menu" icon disappears.

13.3 How to Display the Alarm Events

Enter the "menu":

1. Use ▲ or ▼ keys to find **"ALrM"** label.
2. Push and release the **"SET"** key.
3. Use ▲ or ▼ keys to scroll the alarm list.

To exit the function "menu" push and release the "menu" key or wait the time-out. The "menu" icon disappears.

13.4 How to Reset an Alarm Event

- 1) Enter the function "menu".
- 2) Use ▲ or ▼ keys to find the **"ALrM"** label.

- 3) Push and release the **"SET"** key the lower display shows the alarm code.
- 4) Lower display shows the alarm code.
Upper display shows **"rSt"** label if the alarm can be reset, **"NO"** label if it is not possible.
Use **▲** or **▼** keys to scroll the alarm list.
- 5) Push **"SET"** key when **"rSt"** is lighted to reset the alarm; after a while the read-out move to next alarm.
- 6) To exit the function menu push and release the **"menu"** key or wait the time-out.
The "menu" icon disappears.

13.5 Compressors And Pumps Working hours

Enter the function **"menu"**.

Use **▲** or **▼** keys to find on the lower display:

- **C1Hr** (Compressor n°1 working hours),
- **C2Hr** (Compressor n°2 working hours),
- **PFHr** (Evaporator Water pump or supply fan working hours),
- **PCHr** (Condenser water pump working hours).

The clock icon  is lighted.

13.6 Reset Working Hours

1. Enter the function **"menu"**.
2. Use **▲** or **▼** keys to find on the lower display the C1Hr, C2Hr, PFHr or PCHr.
3. Push **"SET"** key for 3 seconds: the upper display shows "0" indicating the reset.
4. To exit the function menu push and release the **"menu"** key or wait the time-out.
The "menu" icon disappears.

13.7 How to Display the Delay Time Between Two Defrost

1. Enter the function **"menu"**.
2. Use **▲** or **▼** keys to find on the upper display the **"dEF"** label; the lower display shows delay time between two defrost (minutes and seconds).
3. The icon  is flashing.
4. To exit the function **"menu"** push and release the **"menu"** key or wait the time-out.
The "menu" icon disappears.

13.8 How to See the Alarm Log

1. Enter the function **"menu"**.
2. Use **▲** or **▼** keys to find **"ALOG"** label.
3. Push **"SET"** key: the lower display shows the alarm code, the upper display shows **"n°"** followed by the progressive number.
4. With **▲** or **▼** scroll the alarm list.

5. To exit from **ALOG** function push **"menu"** key or wait the time-out delay is expired.

Memory capacity is **50** alarm structured in a FIFO list (first in first out). Each new alarm will take the place of the oldest alarm contained in the list (the read-out is ordered from the oldest to the newest).

13.9 How to Reset the Alarm Log

- 1) Enter the function **"menu"**.
- 2) Use **▲** or **▼** keys to find **"ALOG"** label.
- 3) Push **"SET"** key.
- 4) Use **▲** or **▼** keys to find **"ArSt"** (Alarm reset) label on the lower display; the upper display shows **"PAS"**.
- 5) Push **"SET"** key and then enter the password value using **▲** or **▼** keys; confirm the value pushing **"SET"** key.
- 6) The **ArSt** label starts flashing for 5s, to confirm the alarm logging data is reset.

14. KEYBOARD FUNCTIONS

14.1 How to See the Set Point Value

Push and release the **"SET"** key.

Lower display shows: **"SetC"** set point chiller;
"SetH" set point heat pump.

The upper display shows the value.

Note:

SetH is available only if configured for Heat Pump.

14.2 How to Change the Set Point Value

- 1) Push and hold **"SET"** key (for about 3 seconds).
- 2) The setpoint value is flashing.
- 3) Use **▲** and **▼** to increase or decrease the new value.
- 4) Push and release **"SET"** key or wait the time-out to exit the programming.

14.3 How to See the real Set Point

When Energy Saving, Dynamic Set Point or Function For Units Without Water Storage Tank are enabled is possible to see the real set point.

When the machine is running:

- push **"SET"** key once: lower display shows **"SetC"** (setpoint chiller) or **"SetH"** (setpoint heat pump) and upper display shows the value.
- push **"SET"** key again:
 - when "Energy Saving" is enabled the lower display shows **"SEts"** (Energy saving setpoint) and upper display shows the value.

- when "Dynamic Set" is enabled, the lower display shows "SEtd" (dynamic set point) and upper display shows the value.
- when the function for units without water storage tank is enabled the lower display shows "Setr" (real set point) and upper display shows its value.
- when two function above are both enabled, the lower display shows "Setr" (real set point) and upper display shows its value.

15. REMOTE ON/OFF

If a digital input is configured as remote on/off, it is possible to switch on or switch off the unit.

The remote ON/OFF:

- It has priority over the keyboard
- The unit can be switched on and off by keyboard only if the digital input set the unit switched on
- When the digital input is disabled the instrument returns to its condition prior to activation
- It is possible to navigate the functions menu

The upper display visualizes "OFF" and the decimal LED will be flashing.

16. HOW TO DISABLE A COMPRESSOR

A compressor can be disabled for maintenance; the unit continues to work normally but only with one compressor.

How to disable a compressor:

1. Access to the programming parameters mode.
2. Set the parameter CO12 = 1 or CO13=1 (compressor 1 or 2 = OFF).

To enable the compressor set C011=0 or CO12= 0.

17. DYNAMIC SET POINT

This function is useful to save energy or to use the unit during particular external air temperature condition.

The setpoint is changed according to the external temperature or 4..20mA trasducer.

The Dynamic Set point function is enabled:

- if Sd01 = 1 and CF06 = 3 (Pb3 probe is configured as 4..20mA signal for dynamic set point), or;
- if Sd01 = 1 and CF07 = 3 (Pb4 probe is configured as outside air temperature).

Pb3 probe configured as 4..20mA input signal:

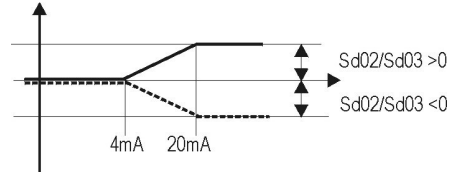

Pb4 probe and positive differential:

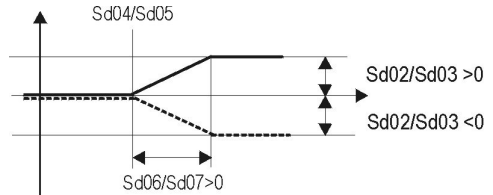

Pb4 probe and negative differential:

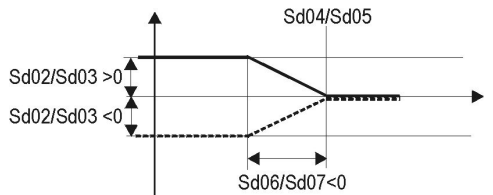

18. ENERGY SAVING

It's possible to change the setpoint for the Energy saving periods.

The activation can be:

- weekly/daily; in this case is required a controller with RTC on board
- by digital input configured as "Energy saving"

The setpoint during an Energy Saving period is:

Chiller: setpoint = SET+ES10 differential=ES11
 Heat pump: setpoint = SET+ES12 differential=ES13

18.1 Daily Programming

It is necessary to set parameters ES03 ÷ ES09 to activate the Energy saving (one parameter for each day of the week).

The value "1" enable the function for that day.

Eg: ES03 = 1 means that every Monday the Energy Saving is activated for all day.

18.2 Programmable timer (RTC is required)

It's possible to activate the Energy Saving for a period of the day by setting the start time end the end time.

ES01 Energy Saving start hour

ES02 Energy Saving stop hour

Eg: **ES01 = 8.0** and **ES02 = 10.0**: Energy Saving is active from 8 to 10.0 for all the days of the week.

Eg: **ES01 = 23.0** and **ES02 = 8.0**: Energy Saving is active from 23.0 to 8.0 of the next morning for all the days of the week.

Energy Saving is disabled if the parameters ES01 / ES02 are both "0".

18.3 Energy Saving by Digital Input

The function is enabled when a digital input, configured as Energy Saving, is activated by remote contact.

19. COMPRESSOR REGULATION

19.1 Compressor regulation in Chiller

Single compressor

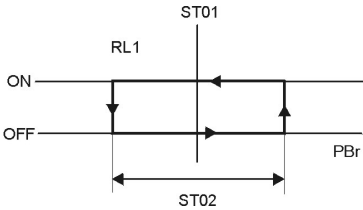

One compressor and one capacity step

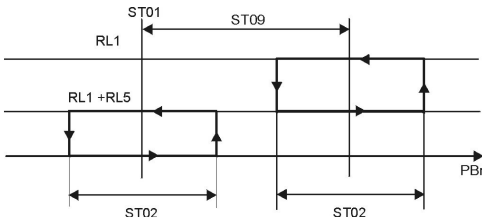

Double compressor machine

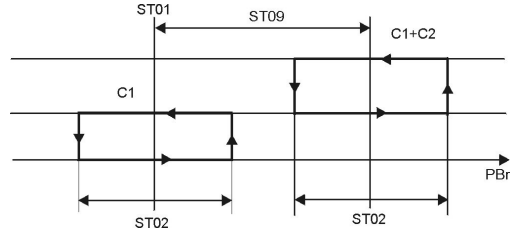

19.2 Compressor Regulation in Heat Pump

Single compressor machine

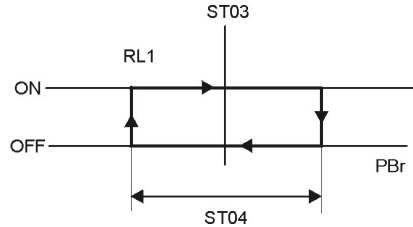

One compressor and one capacity step

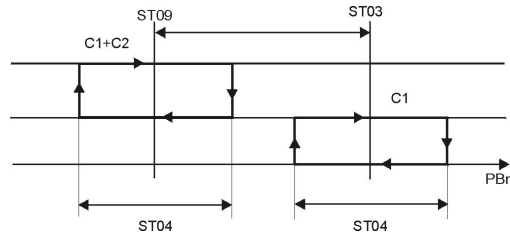

Double compressor machine

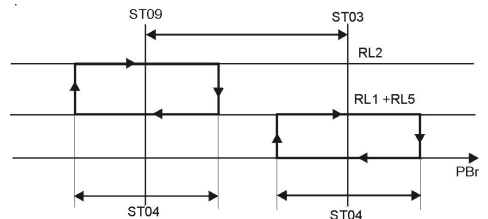

20. CONDENSER FAN REGULATION

20.1 Cooling ON/OFF

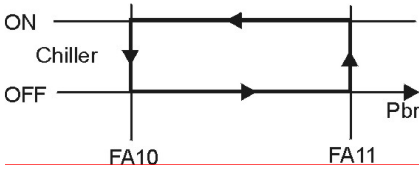

20.2 Heating ON/OFF

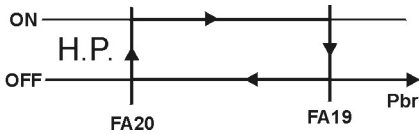

20.3 Cooling Modulating Control (PWM/Triac or 4..20mA / 0..10V Output)

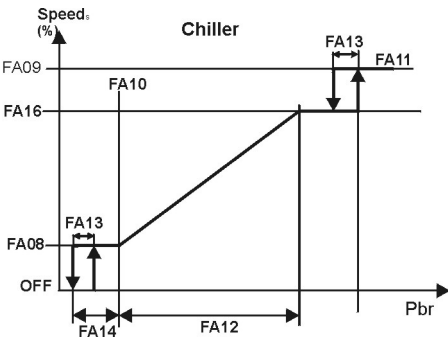

20.4 Heating Modulating Control (PWM/Triac or 4..20mA / 0..10V Output)

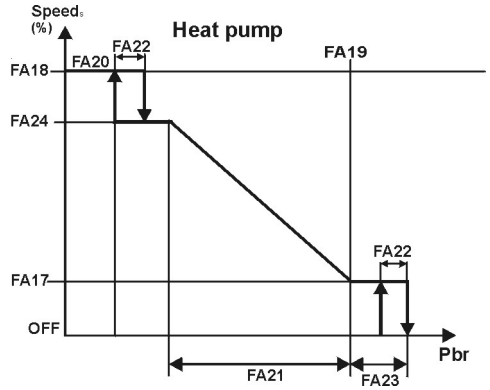

20.5 ON/OFF and modulation control

If the device is configured to manage the condenser fan in ON/OFF and modulation:

- when modulating output ≠ 0, digital output is ON
- when modulating output = 0, digital output is OFF

21. HOT START FUNCTION

This function is available only in air/air units (parameter CF01=0) configured as heat pump and allows to start the supply air fan only if the temperature of the condenser side is hot enough.

21.1 Hot Start Fan Graphic Function

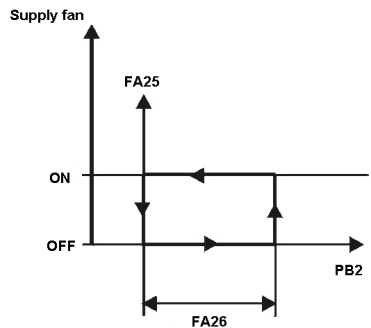

FA25 Set point Hot Start

Set the temperature value, detected by **Pb2** probe, under which the fan is kept locked.

FA26 Differential Hot Start

Set the differential to regulate the fan ON/OFF.

22. AUTOMATIC CHANGE - OVER

This function automatically decides both cooling or heating mode to maintain the optimal comfort; Pb4 has to be configured as external air temperature.

The following conditions have to be satisfied, otherwise the **unit turns to stand-by**:

1. **CF28=2** and **CF07=3** (**Pb4** external air temperature).
2. **Pb4** probe is not faulty.

CF29: set point automatic change-over; it represents the Pb4 value under which the controller turns to Heat Pump mode.

CF30 differential automatic change-over; represents the temperature differential to turns to Chiller mode.

22.1 Graph Regulation of the Change-Over

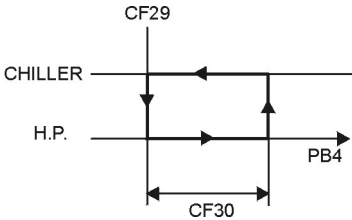

When the temperature value is within the **CF30** range, the changeover is allowed only through keyboard.

23. DEFROST FUNCTION

The defrost cycle is enabled only if the following conditions are satisfied:

1. the unit is working in heat pump mode (heat pump enabled by parameter CF28)
2. the unit is air/air or air/water (CF01=0 or CF01=1)
3. dF01=1 defrost cycle enabled
4. one relay configured as reversing valve
5. Pb3 or Pb4 must be configured as condensing probe (without active faulty probe alarms).

If only one of these conditions is not satisfied the defrost does not operate.

When the condensing temperature/pressure falls below dF03, starts the counting of time dF10. When the counting ends, if the temperature/pressure is lower than dF03 the defrost starts.

The compressor is switched off for dF08 and, after dF08/2, the 4-ways reversing valve is activated. When the counting of dF08 ends the compressor is switched on (CO01 and CO02 are disabled during the defrost).

The defrost ends when the temperature/pressure is >dF04 or for maximum time dF07.

At the end of the defrost, the compressor is switched off for dF09 and, after dF09/2, the 4-ways reversing valve is deactivated.

When the counting of dF09 ends, the compressor is switched on.

23.1 Forced Defrost

This function is enabled if dF05 ≠ 0 and allows to activate a defrost even if the interval time between defrosts is running and the temperature/pressure value is lower than the parameter dF19 for the dF05 time.

If during the time delay dF05 the temperature/pressure becomes higher than dF19+dF20 value, the whole procedure is stopped and the time delay dF05 will be reloaded.

23.2 Combined Defrost

This function is enabled if CF07 = 5 and Pb4 is configured as NTC probe for combined defrost (placed typically on the evaporator coil). The detected temperature allows to calculate a better defrost cycle giving the start and the end commands for the cycle itself.

Functioning:

when the temperature detected by Pb3 probe is lower than dF03, the time delay dF10 starts.

When the time dF10 is elapsed the controller check Pb4 value: if it is lower than dF11 the defrost procedure starts, otherwise the unit still works in Heat Pump.

When Pb4 value is higher than dF12 the combined defrost ends.

23.3 Manual Defrost

This function is enabled if:

- at least one compressor is running
- the condenser temperature/pressure is lower than dF03
- if the "combined defrost" is enabled, Pb4 value must be lower than dF11

If the conditions above are satisfied, by pushing **▲ + SET** (before **▲**, then **SET**) for more than 5 sec. the defrost cycle immediately starts.

24. FUNCTION FOR UNITS WITHOUT WATER STORAGE TANK

This function manages the compressor(s) to optimize the production of refrigerated water in units with low thermal loads.

The function analyses the compressor operating time (from regulation start-up to shutdown request) and compares it with the time configured with parameter CO01 (minimum ON time); when the regulation temperature reach the set point and the operation time is lower than CO01, the controller modifies the set point and the differential to increase the compressor operating time.

If the compressor operates for longer than the minimum time (CO01), when ST15 time is elapsed (this time starts when the CO01 is elapsed) the function progressively restores the set point and hysteresis to the initial values (ST01 or ST03); in this case:

- Heat pump: whenever the time ST15 expires, the function subtracts the ST13 value to the setpoint and ST14 value to the hysteresis
- Chiller: whenever the time ST15 expires, the function adds the ST13 value to the set point and subtracts the ST14 value to the hysteresis.

When the unit is switched OFF (by digital input or by keyboard), the set point and differential are restored to the initial values (ST01...ST04).

Below the formulas for calculating the new set point and hysteresis.

Heat pump:

Set point = set point heat pump + Par ST13 + (CO01 – compressor working time) x ST16 / 10

Differential = differential heat pump + Par.ST14 + (CO01 - actual time) x Par ST16 / 10

Chiller:

Set point = set point cool – [Par ST13+ (CO01 - compressor working time *) x Par ST16 / 10]

Differential = differential chiller + Par.ST14 + (CO01 - compressor working time *) x Par ST16 / 10

*Compressor working time is in sec x 10.

The function for units without water storage tank is compatible with Energy Saving function or with the Dynamic set point.

Visualization of the set point on the display:

Chiller with energy saving or dynamic set point enabled:

- push "SET" button once = SetC (set point value from parameter)
- push "SET" button twice = Sets or Setd (real operating set point value)

Chiller with energy saving or dynamic set point and function for machine without water storage tank enabled:

- push "SET" button once = SetC (set point value from parameter)
- push "SET" button twice = Setr (real operating set point value)

Heat pump with energy saving or dynamic set point enabled:

- push "SET" button once = SetH (set point value from parameter)
- push "SET" button twice = Sets or Setd (real operating set point value)

Heat Pump with energy saving or dynamic set point and function for machine without water storage tank enabled:

- push "SET" button once = SetH (set point value from parameter)
- push "SET" button twice = Setr (real operating set point value)

When the function for units without water storage tank is enabled, the protection for high temperature o low temperature is active; the compressor/s will be switched off if:

Chiller: outlet evaporator temperature < ST11

Heat pump: outlet evaporator temperature > ST12

25. GEOTHERMAL CHILLER FUNCTION

This function, to work, requires the Ichill remote keyboard with internal probe to detect the room temperature; the function is enabled if the parameter CF03=2.

The unit works according to Pb2 probe and the set point ST01 and ST03.

During the regulation, the compressor/s status (only compresor/s status) depend on the room temperature and the user set point configured with parameters ST18 and ST22.

When the room temperature reach the user set point, the compressor/s are switched off; in this case the other loads status (pump, fan, etc.) doesn't depend from compressor status (they work normally).

Manufacturer set point

The unit works on the manufacturer set point:

- set point chiller ST01, differential chiller ST02;
- set point Heat pump ST03, differential Heat pump ST04.

User set point

To visualize the room set point press the "SET" button on the remote keyboard or on the controller.

IC100CX

To change the room set point press and hold the "SET" button: the set point value is displayed flashing on upper display. To change its value press ▲ or ▼ keys and confirm with "SET".

Dynamic set point

The dynamic set point function, if enabled (Sd01=1), works normally (probe PB4) and modify ST01 / ST03 set point. SETd dynamic set point is displayed in the functions menu.

Energy saving

The Energy saving function, if enabled by clock or digital input, modify the room set point (ST18 / ST22).

26. UNLOADING FUNCTION

High temperature inlet evaporator

The function allows the machine to operate in case of high evaporator inlet temperature (to avoid possible high pressure intervention).

When the evaporator inlet temperature is greater than CO17 set point for a time of CO19, a compressor (if two compressors are working) or the capacity control (in case of one compressor with capacity step) is switched off.

When only one compressor is working or only the capacity step is active, the function has not effect on the regulation.

When the function is activated the lower display shows "AEUn" label alternated to default visualization.

The function is disabled if the evaporator inlet temperature is lower than CO17 set point – CO18 differential.

Note

When the unloading function is active, to avoid a prolonged working time in this condition, if the evaporator inlet temperature is lower than CO17 set point and higher than CO17 – CO18 for a time of CO20, the function is disabled.

CO20 delay time starts when the evaporator inlet temperature is lower than CO17 set point.

High pressure in chiller mode

The function allows the machine to operate in case of high outside temperature (start-up in summer with hot external temperature), to avoid possible high pressure alarm.

Pb3 probe has to be configured to use a pressure transducer.

When the evaporator condenser pressure is greater than CO21 set point, a compressor (if two compressors are working) or the capacity control (in case of one compressor with capacity step) is switched off.

When only one compressor is working or only the capacity step is active, the function has not effect on the regulation.

The lower display shows "ACUn" alternated to default visualization.

When the evaporator condenser pressure falls below CO21 – CO22, the function is disabled and, if required for the regulation, the previously shut down compressor/capacity step can be re-inserted.

Note

When the unloading function is active, to avoid a prolonged working time in this condition, if the evaporator condenser pressure is lower than CO21 set point and higher than CO21 – CO22 for a time of CO25, the function is disabled.

CO25 delay time starts when the evaporator condenser pressure is lower than CO21 set point.

Low pressure in heat pump mode

The function allows the machine to operate in case of low outside temperature (start-up in winter with ice-covered batteries), to avoid possible low pressure alarm.

Pb3 probe has to be configured to use a pressure transducer.

When the evaporator condenser pressure is lower than CO23 set point, a compressor (if two compressors are working) or the capacity control (in case of one compressor with capacity step) is switched off.

When only one compressor is working or only a capacity step is active, the function has not effect on the regulation.

The lower display shows "ACUn" alternated to default visualization.

When the evaporator condenser pressure is greater than CO23 + CO24, the function is disabled and, if required for the regulation, the previously shut down compressor/capacity step can be re-inserted.

Note

When the unloading function is active, to avoid a prolonged working time in this condition, if the evaporator pressure is higher than CO23 set point and lower than CO23 + CO24 for a time of CO25, the function is disabled.

CO25 delay time starts when the evaporator pressure is higher than CO23 set point.

27. BOILER FUNCTION

The boiler function can be used for heating (Ar20=1) or for support the heating function (Ar20=0).

To enable the function is necessary:

IC100CX

- unit configured in Heat Pump mode
- Pb4 configured as external air probe (CF07=3)

27.1 Heating Integration Control Ar20=0

Anti-freeze/support heater 1:

Heather ON if:

- outside air temperature < Ar21 for more than Ar23 time
- regulation probe < Heating set point or real Heating set point (if Energy saving or Dynamic set point or function for units without water storage tank are enabled)

Ar23 delay time starts when outside temperature falls below Ar21 set point.

If outside temperature exceeds the Ar21 + Ar22 when the counting of Ar23 is running, the boiler function is not enabled and the Ar23 time is re-loaded.

Heather OFF if:

- outside air temperature > Ar21 + Ar22
- regulation probe > Heating set point or real Heating set point (if Energy saving or Dynamic set point or function for units without water storage tank are enabled)

If outside air temperature falls below the Ar25 set point the compressors are switched off; when outside air temperature is higher than Ar25 set point + the Ar26 differential the compressors are switched on.

Anti-freeze/support heater 2:

Heather ON if:

- outside air temperature < Ar21 for more than Ar23 + Ar24 time
- regulation probe < Heating set point – (ST04 / 2) or real Heating set point – (ST04 / 2) (if Energy saving or Dynamic set point or function for units without water storage tank are enabled)

Ar23 delay time starts when outside temperature falls below Ar21 set point.

Ar24 delay time starts when Ar23 is elapsed.

If the outside temperature exceeds Ar21 + Ar22 when the counting of Ar23 is running, the boiler function is not enabled and the Ar23 time is re-loaded.

Heather OFF if:

- outside air temperature > Ar21 + Ar22
- regulation probe > Heating set point or real Heating set point (if Energy saving or Dynamic set point or function for units without water storage tank are enabled)

If the outside air temperature falls below the Ar25 set point the compressors are switched off; when outside air

temperature is higher than Ar25 set point + the Ar26 differential, the compressors are switched on.

27.2 Heating Control Ar20=1

Anti-freeze/support heater 1:

Heather ON if:

- outside air temperature < Ar21 for more than Ar23 time
- regulation probe < Heating set point or real Heating set point (if Energy saving or Dynamic set point or function for units without water storage tank are enabled)

Ar23 delay time starts when outside temperature falls below Ar21 set point.

When the heather is switched on, the compressor and condenser fans are switched off.

If the outside temperature exceeds Ar21 + Ar22 when the counting of Ar23 is running, the boiler function is not enabled and the Ar23 time is re-loaded

Heather OFF if:

- outside air temperature > Ar21 + Ar22
- regulation probe > Heating set point or real Heating set point (if Energy saving or Dynamic set point or function for units without water storage tank are enabled)

If the outside air temperature exceeds the Ar21 + Ar22 the heater is switched off and the compressor and fans are switched on (if the heat regulator calls for it).

Anti-freeze/support heater 2:

Heather ON if:

- outside air temperature < Ar21 for more than Ar23 + Ar24 time
- regulation probe < Heating set point – (ST04 / 2) or real Heating set point – (ST04 / 2) (if Energy saving or Dynamic set point or function for units without water storage tank are enabled)

Ar23 delay time starts when outside temperature falls below Ar21 set point.

Ar24 delay time starts when Ar23 is elapsed.

If the outside temperature exceeds Ar21 + Ar22 when the counting of Ar23 is running, the boiler function is not enabled and the Ar23 time is re-loaded.

Heather OFF if:

- outside air temperature > Ar21 + Ar22
- regulation probe > Heating set point or real Heating set point (if Energy saving or Dynamic set point or function for units without water storage tank are enabled)

28. MODULATING WATER PUMP

The function is enabled by parameter CO11:
CO11= 3 Modulating pump always on (output 4÷20mA); the pump is on if the unit is on and the pump is off if the unit is off.
CO11= 4 Modulating pump status depends on compressor status (output 4÷20mA); the activation and shutdown of the pump is related to activation and shutdown of the compressor (par CO06, CO07 other than 0)

The controller increases/decreases the evaporator water pump speed to compensate for the decrease/increase evaporator outlet temperature and avoid a possible antifreeze/high temperature alarm.

When the regulation requires the start-up of the compressor, the pump runs at maximum speed for the time set by parameter CO31, after which the compressor switches on and pump regulation starts.

When the device is turned-off (Stand-by or remote OFF) the pump is forced to run at maximum speed for the CO07 time and then switched off.

- When the compressor is off, the pump is:
- on at the speed configured by parameter CO34 if CO11=3
 - off if CO11=4.

Chiller function:

The fan speed is proportional to the evaporator outlet water temperature: the lower is the temperature the faster is the pump rotation speed.

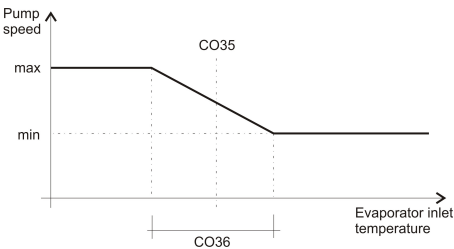

Heat Pump function:

The condenser fan speed is proportional to the evaporator outlet temperature: the lower is the temperature the lower is the pump rotation speed.

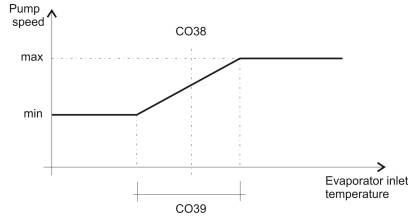

When the temperature of the regulation probe reach the set point (ST01 or ST03) the compressor is not switched off immediately; the pump is forced to run at maximum speed for the time set by parameter (CO37 in chiller and CO40 in heat pump).

When this time is elapsed:

- the pump runs at 100% and the temperature of the regulation probe has reached the set point: the compressor is switched off and the pump starts to run at the speed set by parameter
- the pump runs at 100% but the temperature of the regulation probe hasn't reached the set point: the compressor will continue to operate until the temperature reach the set point.

29. MAINTENANCE FUNCTION

The maintenance warning is activated if the compressor 1, compressor 2, evaporator water pump / supply fan (air/air unit), condenser water pump have worked for a time set by parameter (CO14, CO15, CO16 and CO28).

The maintenance alarm code are:

A13=comp.1, **A14**=comp.2, **A15**=water pump or supply fan, **A20**=condenser pump.

The maintenance warning is only a visual **signaling** and does not influence the regulation.

To reset the warning is necessary to set the operating hours at zero value in the menu function.

30. BLACK OUT

After a black-out:

1. the controller restarts from the pervious status.
2. The defrost cycle is stopped.
3. All the working time delay will be reloaded.

31. ALARM CODE AND EVENTS				
Cod	Meaning	Cause / Origin	Instrument behaviour	Reset
P1	Pb1 probe alarm	Probe Pb1 faulty or disconnected	Open collector / alarm relay ON. Buzzer ON. General alarm icon lighted. Alarm code on display.	Automatic if the probe value recovers
P2	Pb2 probe alarm	Probe Pb2 faulty or disconnected	Open collector / alarm relay ON. Buzzer ON. General alarm icon lighted. Alarm code on display.	Automatic if the probe value recover
P3	Pb3 probe alarm	Probe Pb3 faulty or disconnected	Open collector / alarm relay ON. Buzzer ON. General alarm icon lighted. Alarm code on display.	Automatic if the probe value recovers
P4	Pb4 probe alarm	Probe Pb4 faulty or disconnected	Open collector / alarm relay ON. Buzzer ON. General alarm icon lighted. Alarm code on display.	Automatic if the probe value recovers
A01	High pressure switch alarm	Digital input for high pressure activated	Open collector / alarm relay ON. Buzzer ON. General alarm icon lighted. High pressure icon lighted. Alarm code on display.	Automatic It turns to manual after AL10 intervention Manual: after the alarm event expires, proceed with manual reset.
A02	Low pressure switch alarm	Digital input for low pressure activated	Open collector / alarm relay ON. Buzzer ON. General alarm icon lighted. Low pressure icon lighted. Alarm code on display.	Automatic. It turns to manual after AL02 events in 1 hour. Manual: after the alarm event expires, proceed with manual reset.

A03	Low temperature alarm of the supplied temperature	If CF01=0,1 and Pb1< AR03 for AR05 seconds.	Open collector / alarm relay ON. Buzzer ON. General alarm icon lighted. Alarm code on display.	Automatic: when Pb1 value increases over AR03+AR04 value.
A04	Low temperature alarm of the outlet air from evaporator.	If CF01=0,1 and Pb2< AR03 for AR05 seconds	Open collector / alarm relay ON. Buzzer ON. General alarm icon lighted. Alarm code on display.	Automatic. It turns to manual after Ar06 events in 1 hour. Manual: the event expires if Pb2 > (AR03+ AR04), then proceed with manual reset.
A05	High temperature High pressure	Pb3 o Pb4 > AL11	Open collector / alarm relay ON. Buzzer ON. High alarm icon lighted. Alarm code on display.	Automatic. It turns to manual after AL10 events in 1 hour. Manual: the event expires if Pb3 or Pb4 < (AL11-AL12), then proceed with manual reset.
A06	Low temperature Low pressure	Pb3 o Pb4 < AL14	Open collector / alarm relay ON. Buzzer ON. General alarm icon lighted. Low alarm icon lighted. Alarm code on display.	Automatic. It turns to manual after AL06 events in 1 hour. Manual: the event expires if Pb3 or Pb4 > (AL14+AL15), then proceed with manual reset.
A07	Anti freeze alarm	Digital input active; Anti freeze probe Pbr < AR03 in chiller mode for minimum AR05 seconds Pbr < AR27 in heat pump mode for minimum AR05 seconds	Open collector / alarm relay ON. Buzzer ON. General alarm icon lighted. Alarm code on display.	Automatic. It turns to manual after Ar06 events in 1 hour. Manual: the event expires if Pbr > (AR03+AR04) or Pbr > (AR27+AR28), or the event expires (digital input) then proceed with manual reset.
A07	Anti freeze alarm motocondensing unit	Digital input active CF01=6,7 and CF05=2	Open collector / alarm relay ON. Buzzer ON. General alarm icon lighted. Alarm code on display.	Automatic. It turns to manual Ar06 events in 1 hour. Manual: the event expires, then proceed with manual reset.

A08	Evaporator water flow alarm (air/water or water/water units)	If CO11≠0: digital input active for AL06; the alarm signal is disabled for AL04 starting from the start-up of the evaporator pump. If CO11=0: digital input active for AL06.	<ul style="list-style-type: none"> • If CO11=0 Alarm relay/ open collector ON. Buzzer ON. General alarm icon lighted. Flashing "Flow!" icon. Code on display. If the unit is in std-by or OFF the icon is on to indicate the the real state of the pump and the flow switch. • If CO11≠0 Alarm relay/ open collector ON. Buzzer ON. General alarm icon lighted. Flashing "Flow!" icon. Code on display. 	<p>Automatic. Digital input not active for AL07. It turns to manual if the digital input is active for AL05.</p> <p>Manual: Digital input not active for AL07, then proceed with manual reset.</p>
A09	Compressor 1 thermal protection alarm	Digital input active; bypassed for AL08 upon start-up of compressor	Open collector / alarm relay ON. Buzzer ON. General alarm icon lighted. Alarm code on display.	Manual: the event expires, then proceed with manual reset.
A10	Compressor 2 thermal protection alarm	Digital input active	Open collector / alarm relay ON. Buzzer ON. General alarm icon lighted. Alarm code on display.	Manual: the event expires, then proceed with manual reset.
A11	Condenser fan thermal protection alarm	Digital input active	Open collector / alarm relay ON. Buzzer ON. General alarm icon lighted. Alarm code on display	Manual: the event expires, then proceed with manual reset.
A12	Defrost error alarm	Defrost ended for maximum time dF07 with dF02=1	General alarm icon lighted. Only alarm code on display.	Automatic: with next proper defrost cycle. Proceed with manual reset.

A13	Compressor 1 maintenance warning	Running hour > CO14	Open collector / alarm relay ON. Buzzer ON. General alarm icon lighted. Alarm code on display.	Manual: Proceed with the hour reset procedure 13.6
A14	Compressor 2 maintenance warning	Running hour > CO15	Open collector / alarm relay ON. Buzzer ON. General alarm icon lighted. Alarm code on display.	Manual: Proceed with the hour reset procedure 13.6
A15	Water pump or supply air fan (air/air) maintenance warning	Running hour > CO16	Open collector / alarm relay ON. Buzzer ON. General alarm icon lighted. Alarm code on display.	Manual: Proceed with the hour reset procedure 13.6
A16	High temperature evaporator inlet water	Activation from analogue input (in following priority: PB3 -> PB4 -> PB1->PB2), if probe value > AL24. The alarm is disabled for AL26 starting from ON compressor.	Alarm relay/ open collector ON. Buzzer ON. General alarm icon lighted . Code on display	Automatic If probe value < (AL24 – AL25). With unit OFF or in std-by. Becomes manual after AL27 intervention. Manual De-activation: probe value < (AL24 – AL25) and manual reset.
A17	Thermal protection alarm for evaporator water pump / supply fan	Digital input activation	Alarm relay/ open collector ON. Buzzer ON. General alarm icon lighted . Code on display	Manual the event expires, then proceed with manual reset
A18	Thermal protection alarm for condenser water pump	Digital input activation	<ul style="list-style-type: none"> • If CO11≠0 Activates alarm relay/ open collector output. Activates buzzer. General alarm icon lighted . Flashing flow regulator alarm icon. Code on display	Manual the event expires, then proceed with manual reset

A19	Condenser water flow alarm	Enabled if AL32≠0. If CO26≠0: digital input active for AL30; the alarm is disabled for AL04 starting from the start-up of the condenser pump. If CO26=0: digital input active for AL30.	Alarm relay/ open collector ON. Buzzer ON. General alarm icon lighted . Flashing "Flow!" icon. Code on display. If the unit is in std-by or OFF the icon is on to indicate the real state of the pump and the flow switch.	Automatic Digital input not active for AL31. It turns to manual if the digital input is active for AL29. Manual Digital input not active for AL31 and proceed with manual reset.
A20	Condenser water pump maintenance alarm	Operating hours > CO28	Alarm relay/ open collector ON. Buzzer ON. General alarm icon lighted. Code on display.	Manual Reset operating hours, point 13.6
rtC	Clock alarm	Need to set the clock time	Open collector / alarm relay ON Buzzer ON General alarm icon lighted Alarm code on display	Manual: Set the clock and then proceed with manual reset.
rtF	Clock alarm	Faulty clock control	Open collector / alarm relay ON Buzzer ON General alarm icon lighted Alarm code on display	Manual: Proceed with manual reset, if nothing happens change the clock.
EE	EEPROM error alarm	Possible data losing	Open collector / alarm relay ON Buzzer ON General alarm icon lighted Alarm code on display	Manual: Proceed with manual reset, if nothing happens the controller is locked, no regulation available.
ACF1	Configuration alarm	Heat pump configured without reversing valve	Open collector / alarm relay ON Buzzer ON General alarm icon lighted Alarm code on display	Automatic After parameter proper debug.

ACF2	Configuration alarm	<p>Air/air or H2O/air unit and:</p> <ul style="list-style-type: none"> Fa02≠0 and ventilation probe not configured Chiller parameters configuration differs from FA13<FA14 and FA10+FA12+FA13<FA11 Heat Pump parameters configuration differs from FA22<FA23 and FA20+FA21+FA22<FA19 <p>If Ar18=2 or 3 and CF07≠3 If Ar31=2 or 3 and CF07=3 If CF01=3 and CF07≠6</p>	<p>Open collector / alarm relay ON Buzzer ON General alarm icon lighted Alarm code on display</p>	<p>Automatic After parameter proper debug.</p>
ACF3	Configuration alarm	Two digital inputs having the same function; two relays having the same function	<p>Open collector / alarm relay ON Buzzer ON General alarm icon lighted Alarm code on display</p>	<p>Automatic After parameter proper debug.</p>
ACF4	Configuration alarm	CF28= 1 & digital input not configured or CF28= 2 probe Pb4 ≠ 3	<p>Open collector / alarm relay ON Buzzer ON General alarm icon lighted Alarm code on display</p>	<p>Automatic After parameter proper debug.</p>
ACF5	Configuration alarm	CF02 =1 & (CF04 ≠2,3 & CF05 ≠ 3) or (CF04 = 2 and CF05 = 3)	<p>Open collector / alarm relay ON Buzzer ON General alarm icon lighted Alarm code on display</p>	<p>Automatic After parameter proper debug.</p>
FErr	Functioning alarm	CF04=3, CF05=3 and both digital input activated at the same time	<p>Open collector / alarm relay ON Buzzer ON General alarm icon lighted Alarm code on display</p>	<p>Manual: after the alarm event expires, proceed with manual reset.</p>
AFr	Frequency alarm	The frequency of power supply is out of range	<p>Open collector / alarm relay ON Buzzer ON General alarm icon lighted Alarm code on display</p>	<p>Automatic When the frequency is on the range</p>

ALOC	General alarm for machine block	Digital input activated for continuous time > AL21. Alarm enabled only if AL23=1	Alarm relay/ open collector ON. Buzzer ON Flashing flow regulator alarm icon Code on display	Automatic Becomes manual after AL20 intervention Manual De-activation: digital input not enabled for continuous time > AL22 and manual reset procedure.
bLOC	General alarm, signal only	Digital input activated for continuous time > AL21. Alarm enabled only if AL23=0	Alarm relay/ open collector ON. Buzzer ON. Flashing flow regulator alarm icon Code on display	

32. OUTPUT LOCK FOR ALARM EVENT TABLE

Alarm code	Alarm description	Comp. 1	Comp. 2	Antifreezer heater	Water pump	Supply air fan	Cond. fan
P1	Pb1 Probe Alarm	Yes	Yes	Yes with Ar19 =0			Yes
P2	Pb2 Probe Alarm	Yes	Yes	Yes with Ar19 =0			Yes
P3	Pb3 Probe Alarm	Yes	Yes	Yes with Ar19 =0			Yes
P4	Pb4 Probe Alarm	Yes	Yes	Yes with Ar19 =0			Yes
A01	High pressure alarm from digital input	Yes	Yes				60 sec On (max speed in modulation mode), then OFF
A02	Low pressure alarm from digital input	Yes	Yes				Yes
A03	Low temperature alarm of supplied air						
A04	Low temperature outlet air	Yes	Yes	Yes		Yes	
A05	High temperature / high pressure alarm	Yes	Yes				60 sec On (max speed in modulation mode), then OFF
A06	Low temperature / low pressure alarm	Yes	Yes				Yes
A07	Anti freezer digital input	Yes	Yes				Yes
A07	Anti-freeze digital input alarm	Yes	Yes				Yes
A07	Anti-freeze alarm motocondensing unit	Yes	Yes			Yes	Yes

A08	Evaporator water flow alarm	Yes	Yes	Heater boiler Yes	-	Evaporator water pump Yes (only if the alarm is manual reset)		
A09	Compressor 1 thermal protection	Yes						
A10	Compressor 2 thermal protection		Yes					
A11	Condenser fan thermal protection	Yes	Yes					Yes
A12	Defrost error							
A13	Compressor 1 maintenance							
A14	Compressor 2 maintenance							
A15	Water pump / supply air fan maintenance							
A16	High temperature evaporator inlet water	Yes	Yes					
A17	Evaporator water pump thermal protection	Yes	Yes			Evaporator water pump Yes		
A17	Circulating fan thermal protection	Yes	Yes	Integration heater Yes			Yes	
A18	Condenser water pump thermal protection	Yes	Yes			Condenser water pump Yes		
A19	Condenser water flow alarm	Yes	Yes			Condenser water pump Yes (only with manual restart alarm)	Yes	
A20	Condenser water pump maintenance							
rtC	Clock alarm							
rtF	Clock alarm							
EE	Eeprom error	Yes	Yes	Yes		Yes	Yes	Yes
ACF1	Configuration alarm	Yes	Yes	Yes		Yes	Yes	Yes
ACF2	Configuration alarm	Yes	Yes	Yes		Yes	Yes	Yes
ACF3	Configuration alarm	Yes	Yes	Yes		Yes	Yes	Yes
ACF4	Configuration alarm	Yes	Yes	Yes		Yes	Yes	Yes
ACF5	Configuration alarm	Yes	Yes	Yes		Yes	Yes	Yes
FErr	Functioning error (motocondensing unit)	Yes	Yes			Yes	Yes	Yes
AFr	Frequency alarm	Yes	Yes	Yes		Yes	Yes	Yes
ALOC	Generic alarm for machine block	Yes	Yes	Yes		Yes	Yes	Yes
bLOC	Generic alarm							

33. PARAMETER DESCRIPTION

33.1 Regulation Parameters

- ST01** Setpoint in Chiller mode(range ST05..ST06).
ST02 Differential of the Chiller mode.
ST03 Setpoint in Heat Pump mode (range ST07..ST08)
ST04 Differential of the Heat Pump mode.
ST05 Minimum limit value of ST01 settable for Chiller mode (range -40°C / °F...ST01).
ST06 Maximum limit value of ST01 settable for Chiller mode (range ST01...110 °C / 230°F).
ST07 Minimum limit value of ST03 settable for Heat Pump mode (range -40°C / °F...ST03).
ST08 Maximum limit value of ST03 settable for Heat Pump mode (range ST03...110 °C / 230°F).
ST09 Regulation band
ST10 Enables the function for machines without water storage tank
ST11 Minimum temperature for outlet water in chiller function at which the compressors are stopped
ST12 Maximum temperature for outlet water in chiller function at which the compressors are stopped
ST13 Delta set point for chiller / HP function
ST14 Delta differential for chiller / HP function
ST15 Compressor operation time above which the delta set point and delta differential for chiller / HP function is decreased
ST16 Constant for calculating the set point value and differential for chiller / HP function
ST17 Delay for changing the operating set point. After the initial change, any other changes to the operating set point are made after the delay set by the parameter.
ST18 Room set point in chiller mode to enable the compressors of units without water storage tank.
ST19 Room differential in chiller mode for units without water storage tank.
ST20 Minimum value of the set point in chiller function for machines without storage.
ST21 Maximum value of the set point in chiller function for machines without storage.
ST22 Room set point in heat pump mode to enable the compressors of units without water storage tank.
ST23 Room differential in heat pump mode for units without water storage tank.
ST24 Minimum value of the set point in HP function for machines without storage.
ST25 Maximum value of the set point in HP function for machines without storage.

33.2 Configuration parameters

CF01 configure the type of the unit. Based on this parameter some parameters can be hidden. (see the table - menu)

Type of unit:

0= air / air unit

1= air / water unit

2 = water / water unit

3= air / water unit with reversal on water circuit

CF02 Motocondensing Unit

0= No

1= Yes

CF03 Regulation probe

0= Pb1 probe control

1= Pb2 probe control

2= PB2 probe control and compressors control on probe Pb1 and user set point (geothermal chiller)

CF04 Pb1 analogue input configuration:

0 = No Probe

1 = NTC probe for evaporator water inlet / controlled air showed on the upper display.

2 = Digital input for Motocondensing unit.



When the contact is not active the unit turns to stand-by, upper display shows OFF.



The active input turns the unit in stand-by but the upper display shows ON.



In this situation using   keys is possible to start the functioning in Chiller or Heat Pump mode:

in Chiller mode the upper display shows OnC. If double compressor units and CO08=1 the 1st compressor starts, with double compressor units and CO08=0 the compressor with less working hours starts.

in Heat Pump mode the upper display shows OnH: with double compressor units and CO08=1 the 1st compressor starts, with double compressor units and CO08=0 the compressor with less working hours starts.

If the digital input becomes not active and then active again the unit stops and then restarts with the selected mode. Only with active input is possible to change the functioning again through   keys.

3 = Digital input for motocondensing unit. It turns the unit on only in Chiller mode, the upper display shows OnC. If the contact is not active the unit turns to stand-by and the display shows OFF. Only with active contact, if the unit has been turned off through   keys,

is possible to turn it on again through   keys.

CF05 Pb2 input configuration

0 = no Probe

1 = NTC probe temperature "evaporator water outlet"/ "evaporator out air", it is showed on the upper display.

IC100CX

2 = Digital input to generate the anti-freeze alarm, check the polarity.

3 = Digital input for motocondensing. If active it starts the unit in Heat Pump, the upper display shows OnH. While, if not active, the unit is in stand-by, the upper display shows OFF. Only if this input is active is possible to turn Off and On the unit through  keys.

4 = NTC probe for outdoor air control. It works for: Dynamic Setpoint, Boiler and Auto Change-over.

*Note:

if CF05=4 and CF07=3 or CF07=5 the change over, the boiler and the antifreeze regulate on Pb2.

CF06 Pb3 input configuration

0 = no Probe

1 = NTC temperature probe to control the condenser fan speed, it is showed on the lower display.

2 = 4..20mA condensing pressure input to control the condenser fan speed, it is showed on the lower display.

3 = 4..20mA Dynamic Setpoint input signal decided by the user.

4 = NTC condenser probe anti-freeze alarm (water/water or water/water with Heat Pump) , it is showed on the lower display.

5 = NTC high temperature probe of system inlet water

6 = 0..5V condensing pressure input to control the condenser fan speed.

CF07 Pb4 input configuration

0 = no Probe

1 = NTC temperature probe to control the condenser fan speed, it is showed on the lower display.

2 = Configurable digital input.

3 = NTC probe for outdoor air control. It works for: Dynamic Setpoint, Boiler and Auto Change-over.

4 = NTC probe for condenser anti-freeze alarm (water/water or water/water with Heat Pump), It is showed on the lower display.

5= NTC probe to detect the evaporator temperature in Heat Pump and control the Combined Defrost. It determines the defrost start and stop.

6 = NTC probe condenser water (water/water unit with reversal on water side)

7 = NTC hight temperature probe of system inlet water

CF08 Digital input configuration **ID1**

CF09 Digital input configuration **ID2**

CF10 Digital input configuration **ID5**

0= If active it generates a compressor 1 thermal protection alarm.

1= If active it generates a condenser fan thermal protection alarm.

2= If active it generates a water flow switch alarm (water/air units, water/water units)

3= If active it generates a remote OFF command. The instrument keyboard works only if the input is not active.

4= Remote "Chiller / Heat Pump" command. The instrument keyboard can start the unit only with the operating mode selected by remote. (See **CF28 = 1**) .

5= If active it generates a 2nd compressor thermal protection alarm.

6= External call for 2nd compressor / stage (Motocondensing).

7 = If active it determines the end defrost cycle.

8 = If active it enables the Energy Saving function.

9 = If active it generates an "Anti ice alarm".

10= 1st and 2nd compressors thermal protection

11= Generic alarm for machine block

12= If active it generates evaporator water pump thermal protection alarm / supply fan thermal protection alarm

13= Alarm for thermal protection of condenser water pump

14= If active it generates a condenser water flow switch alarm

15= Not used

CF11 determines the functions of Pb4 when configured as digital input:

0= If active it generates a compressor 1 thermal protection alarm.

1= If active it generates a condenser fan thermal protection alarm.

2= If active it generates a water flow switch alarm (water/air units, water/water units)

3= If active it generates a remote OFF command. The instrument keyboard works only if the input is not active.

4= Remote "Chiller / Heat Pump" command. The instrument keyboard can start the unit only with the operating mode selected by remote. (See **CF28 = 1**) .

5= If active it generates a 2nd compressor thermal protection alarm.

6= External call for 2nd compressor / stage (Motocondensing).

7 = If active it determines the end defrost cycle.

8 = If active it enables the Energy Saving function.

9 = If active it generates an "Anti ice alarm".

10= 1st and 2nd compressors thermal protection

11= Generic alarm for machine block

12= If active it generates evaporator water pump thermal protection alarm / supply fan thermal protection alarm

13= Alarm for thermal protection of condenser water pump

14= Condenser flow

15= Not used

CF12 Digital input polarity **ID1**

CF13 Digital input polarity **ID2**

CF14 Digital input polarity **ID3**

CF15 Digital input polarity **ID4****CF16** Digital input polarity **ID5****CF17** Input polarity of **Pb1** when set as digital input.**CF18** Input polarity of **Pb2** when set as digital input.**CF19** Input polarity of **Pb4** when set as digital input.

0 = Input active for closed contact.

1 = Input active for open contact.

CF20 Configuration of the relay n°4.

0 = Alarm relay

1 = compressor 1 parzialization

2 = compressor 2

3 = ON/OFF ventilation

4 = reversing valve

5 = Anti-freezer heaters / integration heater n.1

6 = solenoid valve on water side

7 = solenoid valve on water side only when working with Heat Pump

8= Anti-freezer heater / integration heater n.2

9 = evaporator water pump / supply fan (air / air unit)

10= condenser water pump.

CF21 Configuration of the relay n°5.

0 = Alarm relay

1 = compressor 1 parzialization

2 = compressor 2

3 = ON/OFF ventilation

4 = reversing valve

5 = Anti-freezer heaters / integration heater n.1

6 = solenoid valve on water side

7 = solenoid valve on water side only when working with HP

8= Anti-freezer heater / integration heater n.2

9 = evaporator water pump / supply fan (air / air unit)

10= condenser water pump

Note rele° n°5 output polarity.

If CF21 = 0 open collector output polarity is settled by the AL18 parameter.

If CF21 = 1 the stage valve polarity is defined by par. CO10.

CF22 Corresponding pressure value at 4mA / 0,5V (Pb3 probe).**CF23** Corresponding pressure value at 20mA / 5V (Pb3 probe).**CF24** Offset of Pb1 probe to calibrate the read-out.**CF25** Offset of Pb2 probe to calibrate the read-out.**CF26** Offset of Pb3 probe to calibrate the read-out.**CF27** Offset of Pb4 probe to calibrate the read-out.**CF28** It determines which command has the priority to turn the unit in Chiller or Heat Pump.

CF28 = 0 Keyboard commands override the digital input commands (see cap 12).

CF28 = 1 Digital input with priority control commands. It is enabled only when one of the digital inputs is

configured to change the function "Chiller / Heat Pump" of the unit.

If the polarity of that digital input is 0:

- Open contact means Chiller functioning

- Closed contact means Heat Pump functioning.

If the polarity of that digital input is 0:

- Open contact means Heat Pump functioning





- Closed contact means Chiller functioning.

If none of the digital inputs is set to 4, the **unit turns to stand-by**. The keyboard selection is disabled and the unit can run only with the selected mode.**CF28 = 2** Analogue input has priority on instrument keyboard commands. If the temperature is within the **CF30** interval, the changing of status is allowed also from instrument keyboard**CF28 = 3** Enable only Chiller mode**CF28 = 4** Enable only heat pump mode**CF29** change over Set point.If **CF28=1**, **CF28=2** and the unit is running, a request of change the functioning will turn off all the relay outputs. Then the controller will wait few time, signalled by the Chiller or Heat Pump flashing led, before restarting with the compressor delay times of the new functioning.**CF29** Change Over Setpoint.

If the functioning is selected with probe control, it represents the temperature under which Pb4 probe value automatically turns the unit to Heat Pump mode.

CF30 Change Over differential.

If the functioning is selected with probe control, it represents the temperature differential for Pb4 probe value to turns the unit to Chiller mode.

CF31 Chiller and Heat Pump keys configuration.0 = Pushing  key for 5s, it turns on / off the unit in Chiller mode, pushing  key for 5s, it turns on / off in Heat Pump mode.1 = Pushing  key for 5s, it turns on / off the unit in Heat Pump mode, pushing  key for 5s, it turns on / off the unit in Chiller mode.**CF32** Selects the unit of measurement.

0 = Celsius °C / bar

1 = Fahrenheit / psi

CF33 Selects the power supply frequency.

0 = 50 Hz

1 = 60Hz

2 = power DC

CF34 Serial Address for monitoring system.**CF35** Type of remote keyboard.

0 = Not used

1 = 6 keys

2 = 6 keys with internal probe (NTC sensor)

CF36 Allows you to select default viewing of the upper display (red color).

0 = PB1 visualization

- 1 = PB2 visualization
- 2 = no visualization (display off)
- 3 = PB4 visualization
- 4 = real working set point (set point modified from Energy Saving, Dynamic set point, function for units without water storage tank)
- 5 = unit status
- 6 = no visualization (display off)
- 7 = no visualization (display off)
- 8 = woking differential
- 9 = unit set point (parameter value)

CF37 Firmware release identification.

CF38 Eeprom parameter map identification.

CF39 Configuration of the relay n° 2

- 0 = Alarm relay
- 1 = compressor 1 parzalization
- 2 = compressor 2
- 3 = ON/OFF ventilation
- 4 = reversing valve
- 5 = Anti-freezer heaters / integration heater n.1
- 6 = solenoid valve on water side
- 7 = solenoid valve on water side only when working with HP
- 8= Anti-freezer heater / integration heater n.2
- 9 = evaporator water pump / supply fan (air / air unit)
- 10= condenser water pump

CF40 relay n° 3 configuration

- 0 = Alarm relay
- 1 = compressor 1 parzalization
- 2 = compressor 2
- 3 = ON/OFF ventilation
- 4 = reversing valve
- 5 = Anti-freezer heaters / integration heater n.1
- 6 = solenoid valve on water side
- 7 = solenoid valve on water side only when working with HP
- 8= Anti-freezer heater / integration heater n.2
- 9 = evaporator water pump / supply fan (air / air unit)
- 10= condenser water pump

CF41 open collector output configuration

- 0 = Alarm relay
- 1 = compressor 1 parzalization
- 2 = compressor 2
- 3 = ON/OFF ventilation
- 4 = reversing valve
- 5 = Anti-freezer heaters / integration heater n.1
- 6 = solenoid valve on water side
- 7 = solenoid valve on water side only when working with HP
- 8= Anti-freezer heater / integration heater n.2
- 9 = evaporator water pump / supply fan (air / air unit)
- 10= condenser water pump

CF42 Time for reversing the valve when the compressor stops. Whenever all the compressors are stopped for heat regulation, or whenever the machine is stopped (stand-by or remote off), the reversing valve is turned for the number of seconds defined by parameter CF42. The machine is switched back on from OFF-remote or stand-by after a delay, until the time required to reverse the valve set by the parameter has elapsed. After the period for forcing the reversing valve, activation of the compressors is disabled for a set time (5 seconds). If CF42=0 the function is disabled.

CF43 Allows you to select default viewing of the lower display (yellow color).

- 0 = PB1 visualization
- 1 = PB2 visualization
- 2 = PB3 visualization
- 3 = PB4 visualization
- 4 = real unit set point (set point modified from Energy Saving, Dynamic set point, function for units without water storage tank)
- 5 = unit status
- 6 = clock
- 7 = no visualization (display off)
- 8 = woking differential
- 9 = unit set point (parameter value)

CF44 Allows you to select default viewing of the upper display of remote keyboard.

- 0 = PB1 visualization
- 1 = PB2 visualization
- 2 = no visualization (display off)
- 3 = PB4 visualization
- 4 = unit real set point (set point modified from Energy Saving, Dynamic set point, function for units without water storage tank)
- 5 = unit status
- 6 = no visualization (display off)
- 7 = no visualization (display off)
- 8 = woking differential
- 9 = unit set point (parameter value)

CF45 Allows you to select default viewing of the lower display of remote keyboard.

- 0 = PB1 visualization
- 1 = PB2 visualization
- 2 = PB3 visualization
- 3 = PB4 visualization
- 4 = unit real set point (set point modified from Energy Saving, Dynamic set point, function for units without water storage tank)
- 5 = unit status
- 6 = clock
- 7 = no visualization (display off)
- 8 = woking differential
- 9 = unit set point (parameter value)

IC100CX

CF46 Allows you to select what visualize when the controller is in Std-by mode.

0 = default visualization (CF36 and CF43 parameters)

1 = the display visualize "OFF"

2 = the display visualize "StbY"

CF47 Allows you to select what visualize on the remote keyboard when the controller is in Std-by mode.

0 = default visualization (CF36 and CF43 parameters)

1 = the display visualize "OFF"

2 = the display visualize "StbY"

CF48 Analog output configuration

0 = 4..20mA

1 = 0..10V

33.3 Dynamic Setpoint Parameters

Sd01 Dynamic Setpoint configuration.

0 = Function disabled

1 = Function enabled

Sd02 It determines the maximum offset of the setpoint value reachable in Chiller mode.

Sd03 It determines the maximum offset of the setpoint value reachable in Heat Pump mode.

Sd04 External air temperature setpoint in Chiller mode.

Sd05 External air temperature setpoint in H.P. mode.

Sd06 External air temperature differential in Chiller mode.

Sd07 External air temperature differential in Heat Pump mode.

33.4 Energy Saving Parameters

ES01 Energy Saving start time

ES02 Energy Saving stop time

ES03 Monday...**ES09** Sunday

0 = Not enabled; 1 = Enabled

ES10 Energy Saving increment in Chiller mode.

ES11 Energy Saving differential in Chiller mode.

ES12 Energy Saving increment in Heat Pump mode.

ES13 Energy Saving differential in Heat Pump mode.

33.5 Compressor Parameters

CO01 Minimum ON time after compressor activation.

CO02 Minimum OFF time after compressor de-activation. During this time the corresponding icon is flashing.

CO03 Delay time between compressor or stage activation to reduce current peak consumption. During this time the corresponding icon is flashing.

When working with a compressor with stage, if there is a full load request, the stage solenoid is activated and only

after 5 seconds the compressor. After the delay time CO03 if not needed the stage solenoid is turned off.

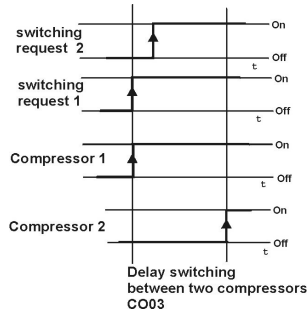

CO04 Off delay time between compressor or stage valve.

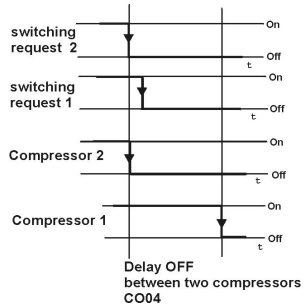

CO05 Delay time at power supply start-up.

All the output relays are delayed for the time set in this parameter to prevent compressor damages from frequent power supply black-outs.

CO06 Compressor switch on delay time after "water pump / air supply fan" relay activation.

Having CO11 = 2 ("water pump / air supply fan" related to compressor on/off status), the "water pump / air supply fan" always starts before the compressors.

Having CO11 = 1 (continuously running of pump/fan) the relay switches on when the controller is turned on in Chiller or Heat Pump mode. No delay time are enabled.

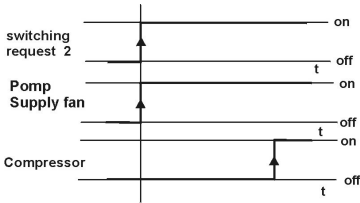

**Delay between on comp.
Pump / supply fan
CO06**

CO07 “Water pump / air supply fan” switch off delay time after compressor deactivating.

Having CO11 = 2 (“water pump / air supply fan” related to compressor on/off status), the “water pump / air supply fan” always stops after the compressors.

Having CO11 = 1 (continuously running of pump/fan) the relay switches off when the controller turns to stand-by mode.

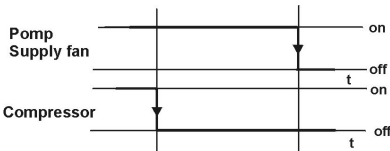

**Delay off pump
supply fan
from comp off CO07.**

CO08 Compressor control sequences.

0 = Compressor rotating sequence.

Depending on the number of running hours the controller enables the compressor with less counted running hours. The switch off sequence stops the compressor with greater number of running hours.

Rotating sequence is not enabled for units having a compressor with a stage.

1 = Fixed sequence control.

Compressor_1 always starts before Compressor_2 and stops always after Compressor_2 stops.

In case of compressor_1 alarm the compressor_2 immediately stops.

CO09 Time delay to turn OFF the solenoid valve (starting from compressor switched off) of the water side.

CO10 Stage polarity valve.

0 = stage active for valve ON (relay closed);

1 = stage active for valve OFF (relay open).

CO11 “Water pump / air supply fan” relay configuration.

0 = Relay not configured..

1 = Continuously running. The relay switches on when the controller is turned to Chiller or Heat Pump mode.

2 = “water pump / air supply fan” is related to compressor on/off status.

3= Modulating pump always on (output 4÷20mA); activation and shutdown of the pump and supply fan relates to activation and shutdown of the unit.

4= Modulating pump depend on compressor status (output 4÷20mA); activation and shutdown of the pump and supply fan relates to activation and shutdown of the compressor (par CO06, CO07 ≠ 0)

CO12 Compressor_1 off line for maintenance.

0 = ON; 1 = OFF

If set to OFF, the compressor is not more included into the regulation and the relay output will never be turned on. To include the compressor this parameter must be set to 0.

CO13 2nd compressor or stage off line for maintenance.

0 = ON; 1 = OFF

If set to OFF, the compressor is not more included into the regulation and the relay output will never be turned on. To include the compressor this parameter must be set to 0.

CO14 Alarm setpoint for compressor n°1 running hour.

Number of compressor running hour before signalling the warning alarm A13. If 0 the function is not enabled.

CO15 Alarm setpoint for compressor n°2 running hour. Number of compressor running hour before signalling the warning alarm A14. If 0 the function is not enabled.

CO16 Alarm setpoint for pump/fan running hour. Number of pump/fan running hour before signalling the warning alarm A15. If 0 the function is not enabled.

CO17 Unloading set point (evaporator side)

CO18 Unloading Differential (evaporator side)

CO19 Delay unloading function (evaporator side)

CO20 Maximum unloading operation time in case of high evaporator temperature

CO21 Unloading pressure set point in chiller mode (condenser side)

CO22 Unloading pressure differential in chiller mode (condenser side)

CO23 Unloading pressure set point in heat pump mode (condenser side)

CO24 Unloading pressure differential in heat pump mode (condenser side)

CO25 Maximum unloading operation time in condenser side

CO26 Condenser water pump operating mode:

0= Not used

1= Continuous operation

The pump is on when the unit is ON; if CO27≠0 and unit is OFF/standby, the pump switches off with a delay set in the parameter.

2=water pump is related to compressor on/off status.

The pump is switched on if the compressor(s) are switched on.

In this case the following parameters are enabled:

CO06 = activation of the compressor delayed by pump activation)

CO27 = shutdown of the pump delayed by compressor shutdown.

CO27 Delay between condenser pump shutdown and compressor shutdown

CO28 Operation hour counter of water condenser pump. Defines the number of operating hours of the condenser water pump after which the A20 alarm is activated (if CF28=0 the function is disabled)

CO29 Maximum continuous operating time of a compressor after which function is rotated (shutdown of enabled compressor and switching on the disabled compressor)

CO30 Compressor start-up delay after activation of the water solenoid valve. When required for heat regulation, the valve is activated and, with the CO30 delay, the compressor is also activated; this enables start-up of the compressors with the external exchanger's inlet water temperature at normal conditions.

CO31 Peak time of modulating pump at maximum speed required by heat regulation

CO32 Minimum speed % of modulating pump in operation with enabled compressor (Chiller)

CO33 Minimum speed % of modulating pump in operation with enabled compressor (heat pump)

CO34 Speed % of modulating pump with compressor off.

CO35 Set point modulating pump in chiller mode

CO36 Temperature control band for water supply in chiller function

CO37 Delay for switching off compressor by heat regulation with water pump < 100 % in chiller function

CO38 Pump speed control set point depending on PB2 outlet water temperature in heat pump function

CO39 Temperature control band of supply water in pdc function

CO40 Delay for switching off compressor by heat regulation with water pump < 100 % in p.d.c function

FA03=1 and FA03=0: fan ON with compressor ON following the ON/OFF regulation of the condensing temperature/pressure trend.

When compressor goes OFF also fan goes OFF.

FA03=1 and FA03=1: fan ON/OFF following the condensing temperature/pressure trend.

FA03=2 and FA03=0: fan ON when compressor ON with proportional regulation (triac and 4.20mA outputs) based on condensing pressure/temperature trend. When compressor goes OFF also fan regulation goes OFF.

FA03=2 and FA03=1: fan ON/OFF with proportional regulation (triac and 4.20mA outputs) based on condensing pressure/temperature trend.

FA03 Condensing fan and compressor status.

0 = Fan related to the compressor status;

1 = Fan independent from compressor.

FA04 Maximum fan speed time after starting request.

If FA02=2 and the condenser fan control is the triac output, when starting the regulation the trigger output will drive the condenser fan at the maximum voltage for the time FA04 then, the regulation will follow the temperature/pressure of the probe.

If FA04 = 0 this function is not enabled.

FA05 Phase shifting of the fan motor.

Used to compensate the different fan motor. It is expressed in micro seconds.

FA06 Not used.

FA07 Maximum fan speed time, in Chiller mode, before switching on the compressor. Used to compensate the condenser pressure rising value to get a better regulation.

If FA07 = 0 this function is not enabled.

FA08 Minimum speed for condenser fan in Chiller mode.

FA09 Maximum speed for condenser fan in Chiller mode.

FA10 Temperature/pressure value that corresponds to the minimum condenser fan speed FA08 in Chiller.

FA11 Temperature/pressure value that corresponds to the maximum condenser fan speed FA09 in Chiller.

FA12 Proportional band for condenser fan control in Chiller mode.

It allows to set the band within the controller increases or decreases the fan speed. (default value is the difference between FA10 and FA11)

FA13 Temperature/pressure differential to stop the condenser fan in Chiller mode.

FA14 Temperature/pressure differential to keep the minimum speed in Chiller mode.

FA15 Time delay before activating the CUT-OFF function after a compressor starting.

If after a compressor starting, the proportional regulation requires to stop the fan (cut-off) and FA15≠0, the

33.6 Ventilation parameters

FA01 It enables the condenser fan output.

0 = Not enabled;

1 = Enabled.

FA02 It selects, with parameter FA03, the type of condenser fan regulation.

FA03=0 and FA03=0: fan ON with compressor ON.

FA03=0 and FA03=1: fan ON but independent from compressor and Off in stand-by.

condenser fan runs at minimum speed for this time. If FA15=0 the function is not enabled.

FA16 Night function (limited speed) in Chiller

It allows to set a limited speed in Chiller to prevent noises. To enable it the value must be lower than FA11.

FA17 Minimum fan speed in Heat Pump Mode.

FA18 Maximum fan speed in Heat Pump Mode.

FA19 Temperature/pressure value that corresponds to the minimum condenser fan speed in Heat Pump.

FA20 Temperature/pressure value that corresponds to the Maximum condenser fan speed in Heat Pump.

FA21 Proportional band for condenser fan control in Heat Pump mode.

It allows to set the band within the controller increases or decreases the fan speed. (default value is the difference between Fa19 and Fa20).

FA22 Temperature/pressure differential to stop the condenser fan in Heat Pump mode.

FA23 Temperature/pressure differential to keep the regulation with the minimum speed in Heat Pump mode.

FA24 Night function (limited speed) in Heat Pump

It allows to set a limited speed in Heat Pump to prevent noises.

FA25 Hot Start Setpoint.

Temperature value detected by Pb2 under which the supply air fan is stopped.

Only for air/air configuration and heat pump mode.

It starts the fan only if the condenser temperature is hot enough avoiding cold air flows.

FA26 Hot start differential.

33.7 Anti-freeze, Boiler, integration heater parameters

Ar01 Anti-freeze: minimum limit for setpoint Ar03 and Ar27 (-40 °C...Ar03)

Ar02 Anti-freeze: maximum limit for setpoint Ar03 and Ar27 (Ar03...110 °C)

Ar03 Anti-freeze alarm setpoint for Chiller units (range Ar01 ...Ar02).

Under this value the controller shows an anti-freeze alarm:

Pb1 ambient air low temperature for air/air unit,

Pb2 low outlet temperature for air/air unit.

Ar04 Anti-freeze alarm differential for Chiller units. It determines the alarm reset if temperature is rising.

Ar05 Anti-freeze alarm delay time. It determines the minimum time, with temperature always lower than Ar03 or Ar27, before signalling the anti-freeze alarm.

Ar06 Maximum anti-freeze alarm number before turning to manual reset procedure. After this number of anti-freeze alarms the controller obliges to execute a manual alarm reset.

Ar07 Anti-freeze alarm delay time of the outlet air when starting in Heat Pump mode.

It determines a delay time before signalling the alarm because the Heat Pump mode will heat the water or the air. If after this time the temperature is still lower than Ar27 the unit is immediately turned off.

Ar08 «Anti-freeze heater / integration heater» Setpoint (air/air unit) in Chiller mode.

Temperature value under which the controller switches on the anti-freeze heater (with probe NTC Pb1-Pb2).

Ar09 «Anti-freeze heater / integration heater» Setpoint for air/air unit in Heat Pump mode.

Temperature value under which the controller switches on the anti-freeze heater (with probe NTC Pb1-Pb2).

Ar10 Setpoint anti-freeze heater for water/water unit in Heat Pump mode.

Temperature value under which the controller switches on the anti-freeze heater (with probe NTC Pb3-Pb4).

Ar11 «Anti-freeze heater / integration heater» differential in Chiller mode.

Ar12 «Anti-freeze heater / integration heater» differential in Heat Pump mode.

Ar13 «Anti-freeze heater / integration heater» configuration.

0 = ON with instrument control.

1 = ON with instrument control and active defrost cycle (always on during defrost)

Ar14 «anti-freeze heater / integration heater» set-up in Chiller.

0 = OFF in Chiller

1 = ON in chiller (on when necessary).

Ar15 anti-freeze heater /integration heater setup in Heat Pump.

0 = OFF in Heat Pump;

1 = ON in Heat Pump (on when necessary)

Ar16 Probe selection for «anti-freeze heater / integration heater» in Chiller mode:

0 = Pb1 probe control;

1 = Pb2 probe control.

2= PB3 probe control

3= PB4 probe control

Ar17 Probe selection for «anti-freeze heater / integration heater» in Heat Pump mode:

0 = Pb1 probe control;

1 = Pb2 probe control

2= PB3 probe control

3= PB4 probe control.

Ar18 Evaporator water pump regulation / anti- freezer heaters. It determines the status of the “anti-freeze heater/integration heater” when the controller functioning is off or stand-by:

0 = Always OFF;

1 = Running on controller demand.

2= Regulation on probe PB4 configured as external temperature with Ar29 set point and A30 differential. The heaters regulate with the probe defined in Ar16 and Ar17 with set point Ar08 and Ar09.

If enabled, the heaters make the water pump work in parallel

3= Regulation of water pump / anti-freezer heaters with probe and separate set points. The pump switches on in accordance with the PB4 probe configured with outside air temperature, Ar29 set point and Ar30 differential; the heaters regulate with the probe configured in Ar16 and Ar17 with set point Ar08 or Ar09.

Ar19 Anti-freeze heater safety for faulty probe.

0 = Always off for faulty probe.

1 = Always on for faulty probe.

Ar20 The Boiler function allows to control the electrical heater in Heat Pump mode:

0 = Integration control; 1 = Heating control.

Ar21 External air Setpoint for electrical heater control.

Ar22 Boiler temperature differential.

Ar23 Activation delay time of the boiler function

Note:

if Ar23=0 the boiler function is disabled

Ar24 Activation delay time of heater n° 2 boiler

Ar25 Outside air set point for disabling the compressors. The compressors are switched off if the boiler function is enabled and the outside temperature < Ar25

Ar26 Outside air differential for enabling the compressors.

Ar27 Anti-freeze alarm set point in heat pump mode

Ar28 Anti-freeze alarm differential in heat pump mode

Ar29 Evaporator/condenser water pump set point with external temperature regulation

Ar30 Evaporator/condenser water pump differential with external temperature regulation

Ar31 Regulation of condenser water pump/ anti-freeze heaters in OFF – standby mode.

0= disabled

1= Switched on in OFF or standby mode (switched on in accordance with the heat regulator). If configured, the condenser water pump and heaters switch on in parallel with regulation of the probes determined in Ar16 and Ar17 with set point Ar08 and Ar09.

2= Regulation of water pump with probe PB4 configured as ambient probe with Ar29 set point and Ar30 differential. The heaters regulate the probe determined in Ar16 and Ar17 with set point Ar08 and Ar09.

If enabled, the heaters request the condenser's water pump to operate in parallel.

3= Regulation of the water pump / anti-freeze heaters with probe and separate set points. The pump switches on in accordance with the PB4 probe configured with outside air temperature, with Ar29 set point and Ar30

differential; the heaters regulate with the probe configured in Ar16 and Ar17, with set point Ar08 and Ar09.

Note:

if Ar18=0, with Ar31 parameter is possible to configure only condenser water pump in OFF/STD-BY.

Ar32 Activation of condenser water pump / anti-freeze heaters in case of probe failure.

0= Off with probe fault

1= On with probe fault.

33.8 Defrost Parameters

dF01 Defrost cycle control.

0 = No; 1 = Yes

dF02 Type of defrost cycle.

0 = Temperature/pressure control. The defrost delay counting time dF10 starts just after the temperature/pressure goes below the setpoint dF03.

The defrost stops for temperature/pressure control.

1 = Maximum time length defrost. The defrost delay counting time dF10 begins just after the temperature/pressure goes below the setpoint dF03.

The defrost stops after the time set in dF07.

2 = External contact defrost. The defrost delay counting time dF10 begins just after the temperature/pressure goes below the setpoint dF03. The defrost starts if the external contact is not active but stops when the contact becomes active.

dF03 Temperature/pressure value under which the defrost delay dF10 starts counting.

dF04 End defrost temperature/pressure setpoint. When the temperature rising over this value the defrost stops.

dF05 Time delay before starting a forced defrost. The function is enabled if dF05 > 0. It starts a defrost cycle (even if dF10 time is not expired), if the temperature/pressure is lower than the set dF19 for the time dF05 duration. If during dF05 the temperature/pressure rises over the set dF19 + dF20 (differential) the defrost cycle is postponed and the delay time dF05 is reloaded.

dF06 Minimum defrost duration. It determines the minimum time duration of a defrost cycle even if the other end defrost conditions have been already satisfied.

dF07 Maximum defrost duration. It determines the end of the defrost if dF02 = 1. In other cases it determines the maximum time.

dF08 Pause time before starting the defrost (the compressor led is flashing). After the dF10 delay, before turning on the defrost cycle, the controller stops the compressor for the time set in dF08. To allows the pressure balancing, exactly in the middle of the dF08 counting (dF08/2), the 4-way reversing valve is activated. The delay times of the compressor are not

calculated. If dF08=0 the compressor does not stop and the 4-way valve is immediately activated.

dF09 Pause time after defrost (the compressor led is flashing). To allow the pressure balancing and the water draining the Heat Pump functioning restarts only after the time set in dF09 parameter. In the middle of dF09 counting the 4-ways valve is deactivated. The compressor delay times are not calculated.

If dF09 = 0 the compressor does not stop and the valve is immediately activated.

dF10 Interval time between defrosts. The counting starts when the condenser temperature/pressure detected (Pb3/Pb4) is lower than DF03. In case of supply black-out or changed functioning mode the defrost is postponed and the dF10 is reloaded. The counting stops if the compressor stops or if the temperature/pressure becomes higher than DF03.

dF11 Start Defrost Setpoint. It is enabled when (Pb4 CF07=5) and (Pb3 CF06=1 or 2).

The counting begins when the temperature/pressure of Pb3 probe becomes lower than dF03. When the dF10 delay time is expired the controller checks the Pb4, if lower than dF11 the defrost starts otherwise the unit will continue in Heat Pump. Just after Pb4 becomes lower than dF11 the defrost starts.

dF12 End of combined defrost temperature.

It permits to set the temperature over which the combined defrost stops working.

The analogue input Pb4 configured in CF07 =5 enables the combined end defrost control. The defrost cycle stops when Pb4 reaches this setpoint.

dF13 2nd Compressor ON during the defrost cycle.

0 = OFF; 1 = 2nd Compressor ON

If the unit is configured with 2 compressors CF21=2 and dF13=1, both the compressors are ON in defrost. The delay times are not calculated therefore ON and OFF compressor is instantaneous.

dF14 Condenser Fan ON during defrost and draining cycles (dF09).

0 = Not Enabled;

1 = Enabled only in defrost cycle;

2 = Enabled in defrost and draining cycles.

If dF14=1 and the condensing temperature/pressure increases over dF15 value, the fan control will be driven with the Chiller configuration fan parameter.

If dF14=2 after the defrost, for the time set in dF09 the fan will be forced to maximum speed.

dF15 Temperature/pressure setpoint to force the fan.

dF16 Low alarm detection during defrost.

0 = not enabled; 1 = enabled.

dF17 Low alarm delay time in Heat Pump mode.

With dF08 and dF09 set to 0 (compressor does not stop and 4-ways valve immediately active), the pressure of the circuit is not well balanced for valve changing. In this

case the dF17 delay starts counting each time the valve changes its status to avoid stopping the unit for low alarm.

dF18 4-ways inverting valve polarity.

0 = Active in chiller; 1 = Active in Heat Pump.

dF19 Temperature/pressure Setpoint to force the defrost cycle.

dF20 Differential for forced defrost.

dF21 Fan status during defrost.

33.9 Alarm Parameters

AL01 Low pressure alarm delay time.

It determines the time delay before signalling the low pressure alarm from digital input.

AL02 Maximum number of "low pressure alarm" / hour before turning to manual reset procedure

AL03 Low alarm detection with unit in Off or Stand-by.

0 = Alarm not enabled; 1 = Alarm enabled.

AL04 Water flow alarm delay time. After starting the water pump the alarm is suppressed for this time.

AL05 Maximum duration of the flow switch alarm before it becomes manual and blocks the water pump.

AL06 Minimum activation time for water flow alarm.

The alarm is detected only if the condition persists for the time set in this parameter. The counting starts only after the **AL04** is expired. It prevents from possible alarms due to the presence of air into the water pipe.

Water flow alarm note: the open collector and relay alarm outputs work only for alarm conditions during the functioning. In the other cases the alarm is only displayed with flashing icon. With Boiler function the active alarm stops the pump. The evaporator is automatically protected with the anti-ice control.

CO11=0 Water pump not present.

The alarm is managed only if one of the digital inputs is configured as water flow, the alarm reset is automatic.

CO11=1 "Water pump on" continuously.

The alarm is managed only if one of the digital inputs is configured as water flow. The alarm reset is automatic if the digital input is activated for more than AL06; the alarm reset is manual if the digital input is activated for more than AL05.

CO11=2 "Water pump on" in parallel with compressor.

The alarm is managed only if one of the digital inputs is configured as water flow.

The alarm reset is automatic if the digital input is activated for more than AL06; the alarm reset is manual if the digital input is activated for more than AL05.

The alarm reset is also permitted if the digital input is still active to permit the pump activation

AL07 Minimum time with inactive water flow input (after alarm event).

After a water flow alarm event, with stop compressor, the regulation restarts only if after this time the digital input is not more active. It prevents from a possible series of short alarms due to the presence of air into the water pipe.

AL08 Thermal protection alarm delay time for compressors.

After switching on the compressor the thermal protection alarm is not detected for the time set in this parameter.

AL09 Number of maximum thermal protection alarm events.

If during one hour the number of thermal alarms reaches the value set in this parameter, the alarm reset turns to manual procedure.

AL10 Maximum number of high temperature / condenser pressure alarm interventions per hour; when this number is reached, the alarm can only be reset manually.

AL11 Condensing high temperature/pressure alarm setpoint. When the condenser probe value increases over this value the instrument detects this high alarm.

AL12 Condensing temperature/pressure differential to reset the high alarm.

AL13 Condensing low temperature/pressure alarm delay time for analogue input. After a compressor starting, the low pressure alarm coming from digital input is delayed for the time set in this parameter.

AL14 Condensing low temperature/pressure alarm setpoint. When the condenser probe value decreases under this value the instrument detects this low alarm.

AL15 Condensing temperature/pressure differential to reset the low alarm.

AL16 Maximum number of low pressure alarms per hour before turning to manual reset procedure.

AL17 Alarm relay and buzzer activation when the unit is in Off or in Stand-by.

0 = Relay and buzzer enabled in case of alarm events;

1 = Relay and buzzer disabled in case of alarm events.

AL18 Allows to set the relay output/open collector polarity

0= Output without voltage in normal conditions, with voltage when there is an alarm

1= Output with voltage in normal conditions, without voltage when there is an alarm

AL19 Allows to choose the probe for the anti- freezer heater alarm.

0= Relative to Ar16 parameters in chiller mode - Ar17 in hp.

1= on Pb1 probe

2= on Pb2 probe

3= on Pb3 probe

4= on Pb4 probe

AL20 Maximum number of general unit block alarm interventions per hour; when this number is reached, the alarm can only be reset manually.

AL21 Generic alarm delay starting from digital input activation

AL22 Delay to reset the generic alarm starting from digital input de-activation

AL23 Generic alarm type

0 = signaling only does not depend on AL20 (alarm relay and buzzer enabled), always reset automatically
1= the alarm blocks the unit; resetting of the alarm depends on the value of the AL20 parameter

AL24 High inlet unit temperature alarm set point

AL25 High inlet unit temperature alarm differential

AL26 High inlet unit temperature alarm delay

AL27 Maximum number of system inlet high temperature alarm interventions per hour, after which the alarm can only be reset manually. If AL27=0 the alarm is always reset manually; if AL27=16 the alarm is always reset automatically

AL28 Condenser water flow alarm delay time. After starting the water pump the alarm is suppressed for this time.

AL29 Maximum duration of the flow switch alarm before it becomes manual and blocks the water pump

AL30 Minimum activation time for water flow alarm.

The alarm is detected only if the condition persists for the time set in this parameter. The counting starts only after the **AL28** is expired. It prevents from possible alarms due to the presence of air into the water pipe.

AL31 Minimum time with inactive water flow input (after alarm event).

After a water flow alarm event the pump regulation restarts only if the digital input is not active for more than AL31.

AL32 Condenser flow switch alarm configuration

0= not used

1= activated only in chiller mode

2= activated only in heat pump mode

3= activated in chiller and heat pump mode

34. PARAMETER TABLE

SUB MENU SELECTIONS

LABEL	Meaning
ALL	Shows the whole set of parameters
ST	It contains only the regulation parameters
CF	It contains only the configuration parameters
SD	It contains only the dynamic Set point parameters
ES	It contains only the Energy Saving parameters
CO	It contains only the compressor parameters
FA	It contains only the fan regulation parameters
Ar	It contains only the anti freeze parameters
DF	It contains only the defrost parameters
AL	It contains only the alarm parameters

Regulation Parameters					
Parameter	Description	Min	Max	Meas.	Resolution
ST01	Summer Set point	ST05	ST06	°C/°F	Decimal integer
ST02	Summer differential	0.0 0	25.0 45	°C °F	Decimal integer
ST03	Winter Set point	ST07	ST08	°C/°F	Decimal integer
ST04	Winter differential	0.0 0	25.0 45	°C °F	Decimal integer
ST05	Minimum set point limit for ST01 (summer)	-50.0 -58	ST01	°C °F	Decimal integer
ST06	Maximum set point limit for ST01 (summer)	ST01	110 230	°C °F	Decimal integer
ST07	Minimum set point limit for ST03 (winter)	-50.0 -58	ST03	°C °F	Decimal integer
ST08	Maximum set point limit for ST03 (winter)	ST03	110 230	°C °F	Decimal integer
ST09	Regulation band	0.0 0	25.0 45	°C °F	Decimal integer
Function for units without water storage tank					
Parameter	Description	Min	Max	Meas.	Resolution
ST10	Chiller unit without water storage tank 0= function disabled 1= function activated	0	1		
ST11	Minimum temperature Set point for outlet water in chiller mode (unit without water storage tank)	-50.0 -58	110 230	°C °F	Dec int

ST12	Maximum temperature Set point for outlet water in HP function (unit without water storage tank)	-50.0 -58	110 230	°C °F	Dec int
ST13	Differential set point for chiller / heat pump function	0.0 0	25.0 45	°C °F	Dec int
ST14	Offset of the differential for chiller / HP function	0.0 0	25.0 45	°C °F	Dec int
ST15	Compressor operation time above which the delta set point and delta differential for chiller / HP function is decreased	0	250	Sec	10 sec
ST16	Constant for calculating the set point value and differential for chiller/HP function	0	250		
ST17	Delay for changing the operating set point	1	250	Sec	10 sec

Geothermal chiller function

Parameter	Description	Min	Max	Meas.	Resolution
ST18	Room set point in chiller function	ST20	ST21	°C/°F	dec/int
ST19	Room differential in chiller function	0.0 0	25.0 45	°C °F	Dec int
ST20	Minimum value of the room set point in chiller function	-50.0 -58	ST18	°C °F	Dec int
ST21	Maximum value of the room set point in chiller function	ST18	110 230	°C °F	Dec int
ST22	Room set point in heat pump function	ST24	ST25	°C/°F	dec/int
ST23	Room differential in heat pump function	0.0 0	25.0 45	°C °F	Dec int
ST24	Minimum value of the room set point in heat pump function	-50.0 -58	ST22	°C °F	Dec int
ST25	Maximum value of the room set point in heat pump function	ST22	110 230	°C °F	Dec int
Pr2	Password	0	999		

Configuration Parameters

Parameter	Description	Min	Max	Meas.	Resolution
CF01	Unit model: 0= Chiller air / air 1= Chiller air / water 2= Chiller water / water 3= Chiller water / water with reversal on water circuit	0	3		
CF02	Motocondensing unit 0= No 1= Yes	0	1		
CF03	Regulation probe 0= Pb1 regulation 1= Pb2 regulation 2= PB2 regulation and compressors activation with user set on PB1 probe	0	2		
CF04	Pb1 configuration 0= Probe not enabled 1= NTC temperature of evaporator inlet 2= Digital input for temperature regulation demand 3= Digital input cooling demand	0	3		

CF05	Pb2 configuration 0= Probe not enabled 1= NTC temperature of evaporator outlet 2= Digital Input for antifreeze alarm 3= Digital input for heating demand 4= External air temperature	0	4		
CF06	Pb3 configuration 0= Probe not enabled 1= NTC temperature condensing control 2= 4..20mA for condensing pressure 3= 4..20ma for Dynamic Set point 4= NTC temperature for anti freeze alarm (water/water) 5= NTC high temperature probe of system inlet water 6= 0..5V for condensing pressure	0	6		
CF07	Pb4 configuration 0= Probe not enabled 1= NTC condensing control 2= Multifunction digital input 3= External air temperature 4= NTC temperature for anti freeze alarm (water/water) 5= NTC temperature for combined defrost 6= NTC temperature for logging 6= NTC condenser outlet temperature (water/water units whith reversal on water circuit) 7= NTC high temperature probe of system inlet water	0	7		
CF08	ID1 configuration 0= 1 st compressor thermal protection 1= Condenser fan thermal protection 2= Evaporator flow switch alarm 3= Remote On/off 4= Remote Cooling/Heating 5= 2 nd compressor thermal protection 6= 2 nd compressor or step request (Motocondensing unit) 7= End defrost 8= Energy Saving 9= Anti Freeze alarm 10= 1 st and 2 nd compressor thermal protection 11= General alarm (unit shutdown) 12= Evaporator water pump thermal protection alarm/ supply fan thermal protection alarm 13= Condenser water pump thermal protection alarm 14= Condenser flow switch alarm 15= not used	0	15		

CF09	ID2 configuration 0= 1 st compressor thermal protection 1= Condenser fan thermal protection 2= Evaporator flow switch alarm 3= Remote On/off 4= Cooling/Heating 5= 2 nd compressor thermal protection 6= 2 nd compressor or step request (Motocondensing unit) 7= End defrost 8= Energy Saving 9= Anti Freeze alarm 10= 1 st and 2 nd compressor thermal protection 11= General alarm for total unit shutdown 12= Evaporator water pump thermal protection alarm/ supply fan thermal protection alarm 13= Condenser water pump thermal protection alarm 14= Condenser flow switch alarm 15= not used	0	15		
CF10	ID5 configuration 0= 1 st compressor thermal protection 1= Condenser fan thermal protection 2= Evaporator flow switch alarm 3= Remote On/off 4= Cooling/Heating 5= 2 nd compressor thermal protection 6= 2 nd compressor or step request (Motocondensing unit) 7= End defrost 8= Energy Saving 9= Anti Freeze alarm 10= 1 st and 2 nd compressor thermal protection 11= General alarm for total unit shutdown 12= Evaporator water pump thermal protection alarm/ supply fan thermal protection alarm 13= Condenser water pump thermal protection alarm 14= Condenser flow switch alarm 15= not used	0	15		
CF11	Pb4 configuration in digital input mode 0= 1 st compressor thermal protection 1= Condenser fan thermal protection 2= Evaporator flow switch alarm 3= Remote On/off 4= Cooling/Heating 5= 2 nd compressor thermal protection 6= 2 nd compressor or step request (Motocondensing unit) 7= End defrost 8= Energy Saving 9= Anti Freeze alarm 10= 1 st and 2 nd compressor thermal protection 11= General alarm for total unit shutdown 12= Evaporator water pump thermal protection alarm/ supply fan thermal protection alarm 13= Condenser water pump thermal protection alarm 14= Condenser flow switch alarm 15= not used	0	15		

CF12	ID1 input polarity 0= active for closed contact 1= active for open contact	0	1		
CF13	ID2 input polarity 0= active for closed contact 1= active for open contact	0	1		
CF14	ID3 input polarity 0= active for closed contact 1= active for open contact	0	1		
CF15	ID4 input polarity 0= active for closed contact 1= active for open contact	0	1		
CF16	ID5 input polarity 0= active for closed contact 1= active for open contact	0	1		
CF17	Pb1 input polarity 0= active for closed contact 1= active for open contact	0	1		
CF18	Pb2 input polarity 0= active for closed contact 1= active for open contact	0	1		
CF19	Pb4 input polarity 0= active for closed contact 1= active for open contact	0	1		
CF20	RL4 configuration of the relay 4 0 = Alarm relay 1 = compressor 1 capacity step 2 = compressor 2 3 = ON/OFF ventilation 4 = reversing valve 5 = anti-freezer heaters / integration heater n.1 6 = solenoid valve on water circuit 7 = solenoid valve on water circuit only for heat pump 8= anti-freezer heaters / integration heater n. 2 9 = evaporator water pump / supply fan (air / air unit) 10= condenser water pump	0	10		
CF21	RL5 configuration of the relay 5 0 = Alarm relay 1 = compressor 1 capacity step 2 = compressor 2 3 = ON/OFF ventilation 4 = reversing valve 5 = anti-freezer heaters / integration heater n.1 6 = solenoid valve on water circuit 7 = solenoid valve on water circuit only for heat pump 8= anti-freezer heaters / integration heater n. 2 9 = evaporator water pump / supply fan (air / air unit) 10= condenser water pump	0	10		
CF22	4mA / 0,5V corresponding to the pressure value of the transducer	0.0 0	50.0 725	Bar Psi	Decimal integer
CF23	20mA / 5V corresponding to the pressure value of the transducer	0.0 0	50.0 725	Bar Psi	Decimal integer
CF24	Pb1 Offset	-12.0 -21	12.0 21	°C °F	Decimal integer

CF25	Pb2 Offset	-12.0 -21	12.0 21	°C °F	Decimal integer
CF26	Pb3 Offset	-12.0 -21 -12.0 -174	12.0 21 12.0 174	°C °F Bar Psi	Decimal Integer Decimal integer
CF27	Pb4 Offset	-12.0 -21	12.0 21	°C °F	Decimal integer
CF28	Chiller or Heat Pump configuration 0= chiller and heat pump selected by keyboard 1= chiller and heat pump selected by digital input 2= chiller and heat pump selected by probe 3= only chiller unit 4= only heat pump unit	0	4		
CF29	Automatic Changeover Setpoint	-50.0 -58	110 230	°C °F	Decimal integer
CF30	Differential for functioning mode	0.1 0	25.0 45	°C °F	Decimal integer
CF31	Chiller or Heat pump key configuration 0= ❄️ chiller / 🔥 heat pump 1= 🔥 chiller / ❄️ heat pump	0	1		
CF32	Celsius or Fahrenheit selection 0= °C / °BAR 1= °F / °psi	0	1		
CF33	Power supply frequency 0= 50 Hz 1= 60 Hz 2 = DC power supply (PWM configured as output for an external alarm relay)	0	2		
CF34	Serial Address for monitoring	1	247		
CF35	Remote terminal keyboard 0= Not used 1= 6 keys 2= 6 keys with NTC probe mounted on board	0	2		
CF36	Default viewing of upper display of the controller 0 = PB1 visualization 1 = PB2 visualization 2 = No visualization 3 = PB4 visualization 4 = Real working set point (set point modified from Energy Saving, Dynamic set point, function for units without water storage tank) 5 = Unit status 6 = No visualization 7 = No visualization 8 = Working differential 9 = Unit set point (parameter value)	0	8		
CF37	Firmware Release				
CF38	Eeprom – Parameter mapping				

<p>CF39</p>	<p>RL2 configuration 0 = Alarm relay 1 = compressor 1 capacity step 2 = compressor 2 3 = ON/OFF ventilation 4 = reversing valve 5 = anti-freezer heaters / integration heater n.1 6 = solenoid valve on water circuit 7 = solenoid valve on water circuit only for heat pump 8= anti-freezer heaters / integration heater n. 2 9 = evaporator water pump / supply fan (air / air unit) 10= condenser water pump</p>	<p>0</p>	<p>10</p>		
<p>CF40</p>	<p>RL3 configuration 0 = Alarm relay 1 = compressor 1 capacity step 2 = compressor 2 3 = ON/OFF ventilation 4 = reversing valve 5 = anti-freezer heaters / integration heater n.1 6 = solenoid valve on water circuit 7 = solenoid valve on water circuit only for heat pump 8= anti-freezer heaters / integration heater n. 2 9 = evaporator water pump / supply fan (air / air unit) 10= condenser water pump</p>	<p>0</p>	<p>10</p>		
<p>CF41</p>	<p>Open collector output configuration 0 = Alarm relay 1 = compressor 1 capacity step 2 = compressor 2 3 = ON/OFF ventilation 4 = reversing valve 5 = anti-freezer heaters / integration heater n.1 6 = solenoid valve on water circuit 7 = solenoid valve on water circuit only for heat pump 8= anti-freezer heaters / integration heater n. 2 9 = evaporator water pump / supply fan (air / air unit) 10= condenser water pump</p>	<p>0</p>	<p>10</p>		
<p>CF42</p>	<p>Switching time of reversing valve when the compressor is switched off</p>	<p>0</p>	<p>250</p>		
<p>CF43</p>	<p>Default viewing of lower display of the controller 0 = PB1 visualization 1 = PB2 visualization 2 = PB3 visualization 3 = PB4 visualization 4 = Real working set point (set point modified from Energy Saving, Dynamic set point, function for units without water storage tank) 5 = Unit status 6 = Clock 7 = No visualization 8 = Working differential 9 = Unit set point (parameter value)</p>	<p>0</p>	<p>8</p>		

CF44	Default viewing of upper display of the remote keyboard 0 = PB1 visualization 1 = PB2 visualization 2 = no visualization (display off) 3 = PB4 visualization 4 = Real working set point (set point modified from Energy Saving, Dynamic set point, function for units without water storage tank) 5 = Unit status 6 = No visualization (display off) 7 = No visualization (display off) 8 = Woking differential 9 = Unit set point (parameter value)	0	8		
CF45	Default viewing of lower display of the remote keyboard 0 = PB1 visualization 1 = PB2 visualization 2 = PB3 visualization 3 = PB4 visualization 4 = Real working set point (set point modified from Energy Saving, Dynamic set point, function for units without water storage tank) 5 = Unit status 6 = Clock 7 = No visualization 8 = Woking differential 9 = Unit set point (parameter value)	0	8		
CF46	Controller: visualization in Std-by mode 0 = default visualization (CF36 and CF43 parameters) 1 = the display visualizes "OFF" 2 = the display visualizes "StbY"	0	2		
CF47	Remote keyboard: visualization in Std-by mode 0 = default visualization (CF36 and CF43 parameters) 1 = the display visualizes "OFF" 2 = the display visualizes "StbY"	0	2		
CF48	Analog output configuration 0 = 4..20mA 1 = 0..10V	0	1		
Pr2	Password value	0	999		
Dynamic Setpoint					
Parameter	Description	Min	Max	Meas	Resolution
Sd01	Dynamic Setpoint 0= Not enabled 1= Enabled	0	1		
Sd02	Maximum summer dynamic Offset	-30.0 -54	30.0 54	°C °F	Decimal integer
Sd03	Maximum winter dynamic Offset	-30.0 -54	30.0 54	°C °F	Decimal integer
Sd04	External air d. setpoint during summer	-50.0 -58	110 230	°C °F	Decimal integer
Sd05	External air d. setpoint during winter	-50.0 -58	110 230	°C °F	Decimal integer
Sd06	External air differential during summer	-30.0 -54	30.0 54	°C °F	Decimal integer

Sd07	External air differential during winter	- 30.0 -54	30.0 54	°C °F	Decimal integer
Pr2	Password value	0	999		
Energy Saving					
Parameter	Description	Min	Max	Meas	Resolution
ES01	Energy saving starting hour (0÷24)	0	23.50	Min	10 Min
ES02	Energy saving ending hour (0÷24)	0	23.50	Min	10 Min
ES03...ES09	Monday...Sunday 0 = Not enabled 1= Enabled	0	1		
ES10	Energy saving setpoint offset in chiller	-30.0 -54	30.0 54	°C °F	Decimal integer
ES11	Energy saving differential in chiller	0.1 0	25.0 45	°C °F	Decimal integer
ES12	Energy saving setpoint offset in heat pump	-30.0 -54	30.0 54	°C °F	Decimal integer
ES13	Energy saving differential in heat pump	0.1 0	25.0 45	°C °F	Decimal integer
Pr2	Password value	0	999		
Compressor parameters					
Parameter	Description	Min	Max	Meas.	Resolution
CO01	Minimum ON time	0	250	Sec	10Sec
CO02	Minimum OFF time	0	250	Sec	10Sec
CO03	ON delay time between two compressors or Comp. and valve	1	250	Sec	
CO04	OFF delay time between two compressors or Comp. and valve	0	250	Sec	
CO05	Output time delay after power supply start-up	0	250	Sec	10Sec
CO06	Compressor On delay time after Pump/"Supply fan" activation	1	250	Sec	
CO07	Compressor OFF delay time after Pump/"Supply fan" de-activation	0	250	Sec	
CO08	Compressor rotating control 0= Enabled 1= Fixed sequence	0	1		
CO09	Time delay for solenoid valve of water side	0	250	Sec	
CO10	Stage vale polarity 0= Capacity stage ON 1= Capacity stage OFF	0	1		
CO11	Water pump / Supply fan operating mode 0= Not used 1= Always on (ON/OFF output) 2= ON if the compressor is on (ON/OFF output) 3= Always on (4÷20mA output) 4= ON if compressor is ON (4÷20mA output)	0	4		
CO12	Compressor 1 0 = Enabled 1 = OFF	0	1		
CO13	Compressor 2 / Stage valve. 0 = Enabled 1 = OFF	0	1		
CO14	Hour counter setpoint for 1 st compressor	0	999	Hr	10 Hr
CO15	Hour counter setpoint for 2 nd compressor	0	999	Hr	10 Hr

CO16	Hour counter setpoint for pump/"Supply fan"	0	999	Hr	10 Hr
Unloading evaporator					
CO17	Unloading set point (evaporator side)	-50.0 -58	110 230	°C °F	Dec int
CO18	Unloading Differential (evaporator side)	0.1 0	25.0 45	°C °F	Dec int
CO19	Delay unloading function (evaporator side)	0	250	Sec	10 Sec
CO20	Maximum unloading operation time in case of high evaporator temperature	0	250	Sec	10 Sec
Unloading condenser					
CO21	Unloading pressure set point in chiller mode (condenser side)	0.0 0	50.0 725	Bar Psi	Dec int
CO22	Unloading pressure differential in chiller mode (condenser side)	0.0 0	12.0 174	Bar Psi	Dec int
CO23	Unloading pressure set point in heat pump mode (condenser side)	0.0 0	50.0 725	Bar Psi	Dec int
CO24	Unloading pressure differential in heat pump mode (condenser side)	0.0 0	12.0 174	Bar Psi	Dec int
CO25	Maximum unloading operation time in condenser side	0	250	Sec	10 Sec
Water pump condenser					
CO26	Condenser water pump operating mode 0= Not used 1= Continuous operation 2= Only for compressor demand	0	2		
CO27	Delay between condenser pump shutdown and compressor shutdown	0	250	Sec	
CO28	SET hour counter of water condenser pump	0	999	Hr	10 Hr
Compressors in tandem mode					
CO29	Maximum continuous operating time of a compressor	0	250	Min	
CO30	Compressor start-up delay after activation of the water solenoid valve	0	250	sec	10 Sec
Modulating evaporator water pump					
CO31	Peak time of modulating pump at maximum speed required by regulation	0	250	sec	
CO32	Minimum speed % of modulating pump in operation with enabled compressor (Chiller)	30	100	%	
CO33	Minimum speed % of modulating pump in operation with enabled compressor (Heat Pump)	30	100	%	
CO34	Speed % of modulating pump in operation with enabled compressor	30	100	%	
CO35	Set point modulating pump in chiller mode (evaporator outlet temperature)	-50.0 -58	110 230	°C °F	Dec int
CO36	Temperature control band for the modulating pump in chiller function	0.0 0	25.0 45	°C °F	Dec int
CO37	Delay for switching off compressor by heat regulation with water pump < 100 % in chiller function	0	250	sec	
CO38	Set point modulating pump in heat pump mode (evaporator outlet temperature)	-50.0 -58	110 230	°C °F	Dec int
CO39	Temperature control band for the modulating pump in heat pump function	0.0 0	25.0 45	°C °F	Dec int
CO40	Delay for switching off compressor by regulation with water pump < 100 % in HP function	0	250	sec	

Pr2	Password	0	999		
Condenser Fan control parameter					
Parameter	Description	Min	Max	Meas.	Resolution
FA01	Fan output 0= Not enabled 1= Enabled	0	1		
FA02	Fan regulation 0= On when compressor On 1= ON / OFF 2= Proportional speed control	0	2		
FA03	Fan related to compressor 0= With compressor 1= Independent from compressor	0	1		
FA04	Maximum speed time when the fan starting	0	250	Sec	
FA05	Phase difference fan	0	20	Micro Sec	250µs
FA06	Not used				
FA07	Cooling pre-ventilation before ON compressor	0	250	Sec	
FA08	Minimum fan speed in summer	30	100	%	
FA09	Maximum fan speed in summer	30	100	%	
FA10	Temperature / pressure setpoint for minimum speed in summer	-50.0 -58 0.0 0	110 230 50 725	°C °F Bar Psi	Decimal integer Decimal integer
FA11	Temperature / pressure setpoint for maximum speed in summer	-50.0 -58 0.0 0	110 230 50 725	°C °F Bar Psi	Decimal integer Decimal integer
FA12	Proportional band in summer	0.0 0 0.0 0	25.0 45 50.0 725	°C °F Bar Psi	Decimal integer Decimal Integer
FA13	CUT-OFF differential in summer	0.0 0 0.0 0	25.0 45 50.0 725	°C °F Bar Psi	Decimal integer Decimal integer
FA14	Override CUT-OFF in summer	0.0 0 0.0 0	25.0 45 50.0 725	°C °F Bar Psi	Decimal integer Decimal integer
FA15	Delay time for CUT-OFF	0	250	Sec	
FA16	Fan speed in summer night function	30	100	%	
FA17	Minimum fan speed in winter	30	100	%	
FA18	Maximum fan speed in winter	30	100	%	
FA19	Temperature / pressure setpoint for minimum speed in winter	-50.0 -58 0.0 0	110 230 50 725	°C °F Bar Psi	Decimal integer Decimal integer

FA20	Temperature / pressure setpoint for maximum speed in winter	-50.0 -58 0.0 0	110 230 50 725	°C °F Bar Psi	Decimal integer Decimal integer
FA21	Proportional band in winter	0.0 0 0.0 0	25.0 45 50.0 725	°C °F Bar Psi	Decimal integer Decimal integer
FA22	CUT-OFF differential in winter	0.0 0 0.0 0	25.0 45 50.0 725	°C °F Bar Psi	Decimal integer Decimal integer
FA23	Override CUT-OFF in winter	0.0 0 0.0 0	25.0 45 50.0 725	°C °F Bar Psi	Decimal integer Decimal integer
FA24	Fan speed in winter night function	30	100	%	
Hot Start Function					
Parameter	Description	Min	Max	Meas.	Resolution
FA25	Hot Start Setpoint	-50.0 -58	110 230	°C °F	Decimal integer
FA26	Hot Start differential	0.1 0	25.0 45	°C °F	Decimal integer
Pr2	Password	0	999		
Anti-freeze / Heater parameters					
Parameter	Description	Min	Max	Meas.	Resolution
Ar01	Minimum value of Anti-Freeze Setpoint	-50.0 -58	Ar03	°C °F	Decimal integer
Ar02	Maximum value of Anti-Freeze Setpoint	Ar03	110 230	°C °F	Decimal integer
Ar03	Anti-freeze Setpoint in chiller mode	Ar01	Ar02	°C/°F	Dec/int
Ar04	Anti-Freeze Differential in chiller mode	0 0	25.0 45	°C °F	Decimal integer
Ar05	Anti-Freeze alarm delay	0	250	Sec	
Ar06	Maximum number of Anti-Freeze alarm events in 1 hour	0	16		
Ar07	Anti-Freeze alarm delay after starting in Heat Pump	0	250	Sec	
Ar08	Anti-Freeze Setpoint of the electrical heater in Chiller mode	-50.0 -58	110 230	°C °F	Decimal integer
Ar09	Anti-Freeze Setpoint of the electrical heater in Heat Pump mode	-50.0 -58	110 230	°C °F	Decimal integer
Ar10	Anti-Freeze Setpoint of external electrical heater (water/water units)	-50.0 -58	110 230	°C °F	Decimal integer
Ar11	Anti-Freeze Differential in Chiller	0.1 0	25.0 45	°C °F	Decimal integer
Ar12	Anti-Freeze Differential in Heat Pump	0.1 0	25.0 45	°C °F	Decimal integer
Ar13	Anti-freeze electrical heater regulation 0= enabled during regulation control 1= enabled active during regulation an defrost	0	1		

Ar14	Anti-freeze electrical heater regulation in Chiller mode 0= OFF in chiller 1= ON in chiller	0	1		
Ar15	Anti-freeze electrical heater regulation in H.P. mode 0= OFF in Heat Pump 1= ON in Heat Pump	0	1		
Ar16	Anti-freeze control probe in Chiller mode 0= Pb1 1= Pb2 2= PB3 probe control 3= PB4 probe control	0	3		
Ar17	Anti-freeze control probe in Heat Pump mode 0= Pb1 1= Pb2 2= PB3 probe control 3= PB4 probe control	0	3		
Ar18	"Water pump"/ "Anti-freeze electrical heater" control with unit in OFF or Stand-by 0= Regulation not enabled 1= Regulation enabled 2= Regulation of water pump/anti-freezer on probe PB4 configured as external temperature probe 3= Regulation of water pump / anti-freezer heaters on probe PB4 and separate set points	0	3		
Ar19	"Water pump"/ "Anti-freeze electrical heater" control for faulty probe 0= output OFF for faulty probe 1= output ON for faulty probe	0	1		

Boiler Function

Parameter	Description	Min	Max	Meas.	Resolution
Ar20	Boiler function 0= Integration control 1= Heating control	0	1		
Ar21	External air Setpoint for Boiler heater activation	-50.0 -58	110 230	°C °F	Decimal integer
Ar22	Boiler function differential	0.1 0	25.0 45	°C °F	Decimal integer
Ar24	Activation delay time of heater n° 2	0	250	Min	
Ar25	Outside air set point for disabling the compressors	-50.0 -58	110 230	°C °F	Dec Int
Ar26	Outside air differential for enabling the compressors	0.1 0	25.0 45	°C °F	Dec int

Anti-freezer alarm in HP function

Ar27	Anti-freeze alarm set point in heat pump mode	Ar01	Ar02	°C / °F	Dec/int
Ar28	Anti-freeze alarm differential in heat pump mode	0 0	25.0 45	°C °F	Dec int

Evaporator water pump functioning / condenser of ambient probe

Ar29	Evaporator/condenser water pump set point with external temperature regulation	-50.0 -58	110 230	°C °F	Dec int
Ar30	Evaporator/condenser water pump differential with external temperature regulation	0.1 0	25.0 45	°C °F	Dec int

Condenser water pump functioning

Ar31	Regulation of condenser water pump/ anti-freeze heaters in OFF – standby mode. 0= de-activated 1= Switched on in OFF or standby mode 2= Regulation of water pump/ anti-freeze heaters with probe PB4 configured as ambient probe 3= Regulation of the water pump / anti-freeze heaters with probe PB4 configured as ambient probe and separate set points.	0	3		
Ar32	Activation of condenser water pump / anti-freeze heaters in case of probe failure. 0= Off with probe fault 1= On with probe fault	0	1		
Pr2	Password	0	999		
Defrost Parameters					
Parameter	Description	Min	Max	Meas.	Resolution
DF01	Defrost control 0= No 1= Yes	0	1		
DF02	Defrost type 0= Temperature / pressure 1= Time 2= External contact	0	2		
DF03	Temperature / pressure Setpoint for starting the defrost cycle	-50.0 -58 0.0 0	110 230 50 725	°C °F Bar Psi	Decimal integer Decimal integer
DF04	Temperature / pressure Setpoint for stopping the defrost cycle	-50.0 -58 0.0 0	110 230 50 725	°C °F Bar Psi	Decimal integer Decimal integer
DF05	Minimum delay time before starting a forced defrost cycle	0	250	Sec	
DF06	Minimum defrost duration	0	250	Sec	
DF07	Maximum defrost duration	0	250	Min	
DF08	Compressor Off time before starting a defrost cycle	0	250	Sec	
DF09	Compressor Off time after a defrost cycle	0	250	Sec	
DF10	Interval time between defrost cycles	1	99	MIN	
DF11	Temperature setpoint to start a combined defrost cycle after the DF10 counting time	-50.0 -58	110 230	°C °F	Decimal integer
DF12	Temperature Setpoint to stop a combined defrost	-50.0 -58	110 230	°C °F	Decimal integer
DF13	Forced activation of the 2 nd compressor in defrost 0= Not enabled 1= Enabled	0	1		
DF14	Forced fan activation during defrost and draining times 0= Not enabled 1= Enabled only for defrost 2= Enabled for defrost and draining time (dF09)	0	2		
DF15	Temperature/Pressure Setpoint to start a forced condensing fan control in defrost cycle	-50.0 -58 0.0 0	110 230 50 725	°C °F Bar Psi	Decimal integer Decimal integer

DF16	Low alarm control during defrost 0= Not enabled 1= Enabled	0	1		
DF17	Low alarm delay time after changing the status of the 4-ways valve	0	250	Sec	
DF18	4-ways reversing valve 0= ON in cooling 1= ON in heating	0	1		
DF19	Temperature/pressure Setpoint to start a forced defrost cycle	-50.0 -58 0.0 0	110 230 50 725	°C °F bar psi	Decimal integer Decimal integer
DF20	Forced defrost cycle differential	0.0 0 0.0 0	25.0 45 50.0 725	°C °F	Decimal Integer Decimal Integer
DF21	Fan status during defrost	0	1		
Pr2	Password	0	999		
Alarm Parameter					
Parameter	Description	Min	Max	Meas.	Resolution
AL01	Low pressure alarm delay time	0	250	Sec	
AL02	Maximum low pressure alarm events in 1 hour	0	16		
AL03	Low pressure alarm with off compressor 0= Not enabled when compressor Off 1= Enabled when compressor Off	0	1		
AL04	"Water flow/Supply fan thermal protection" alarm delay after "water pump / supply air fan" starting.	0	250	Sec	
AL05	Maximum duration of the flow switch alarm before it becomes manual and blocks the water pump	0	250	Sec	
AL06	"Water flow/Supply fan thermal protection" input activation duration	0	250	Sec	
AL07	"Water flow/Supply fan thermal protection" input de-activation duration	0	250	Sec	
AL08	Thermal protection alarm delay after starting the compressor	0	250	Sec	
AL09	Number of maximum thermal protection alarm events.	0	16		
AL10	Maximum number of high temperature / condenser pressure alarm interventions per hour	0	16		
AL11	Condensing temperature/pressure high alarm setpoint for input probe	-50.0 -58 0.0 0	110 230 50 725	°C °F Bar Psi	Decimal integer Decimal integer
AL12	Temperature/pressure high alarm differential for input probe	0 0 0 0	25.0 45 50.0 725	°C °F Bar Psi	Decimal integer Decimal integer
AL13	Low pressure alarm delay for input probe	0	250	Sec	
AL14	Low pressure alarm Setpoint for input probe	-50.0 -58 0.0 0	110 230 50 725	°C °F Bar Psi	Decimal integer Decimal integer

AL15	Low pressure differential for input probe	0 0 0 0	25.0 45 50.0 725	°C °F Bar Psi	Decimal integer Decimal integer
AL16	Maximum number of the low alarm events in 1 hour for input probe	0	16		
AL17	Alarm relay and buzzer activation when the unit is Off or stand-by 0= Alarm relay and buzzer enabled 1= Alarm relay and buzzer disabled	0	1		
AL18	Alarm relay output/open collector polarity 0= Output without voltage in normal conditions, with voltage when there is an alarm 1= Output with voltage in normal conditions, without voltage when there is an alarm	0	1		
AL19	Allows to choose the probe for the anti- freezer heater alarm. 0= Relative to Ar16 parameters in chiller mode - Ar17 in hp. 1= on Pb1 probe 2= on Pb2 probe 3= on Pb3 probe 4= on Pb4 probe	0	4		
AL20	Maximum number of general unit block alarm interventions per hour	0	16		
AL21	General alarm delay starting from digital input activation	0	250	Sec	
AL22	Delay to reset the general alarm starting from digital input de-activation	0	250	10 sec	10 sec
AL23	General alarm type: 0 = signaling only does not depend on AL20 (alarm relay and buzzer enabled), always reset automatically 1= the alarm blocks the unit; resetting of the alarm depends on the value of the AL20 parameter	0	1		
AL24	System's inlet water high temperature alarm set point	-50.0 -58	110 230	°C °F	Dec int
AL25	System's inlet water high temperature alarm differential	0.1 0	25.0 45	°C °F	Dec int
AL26	Delay time for signaling the system's inlet water high temperature alarm	0	250	10 sec	10 sec
AL27	Maximum number of system inlet high temperature alarm interventions per hour	0	16		
AL28	Condenser water flow alarm delay time	0	250	Sec	
AL29	Maximum duration of the flow switch alarm before it becomes manual and blocks the water pump	0	250	Sec	
AL30	Minimum activation time for water flow alarm	0	250	Sec	
AL31	Minimum time with inactive water flow input (after alarm event).	0	250	Sec	
AL32	Condenser flow switch alarm configuration 0= not used 1= activated only in chiller mode 2= activated only in h.p. mode 3= activated in chiller and h.p. mode	0	3		
Pr2	Password	0	999		

35. INSTALLING AND MOUNTING

35.1 "C" Format (32*74mm)

The instrument shall be mounted on panel, in a 29x71 mm hole, and fixed using the special bracket supplied.

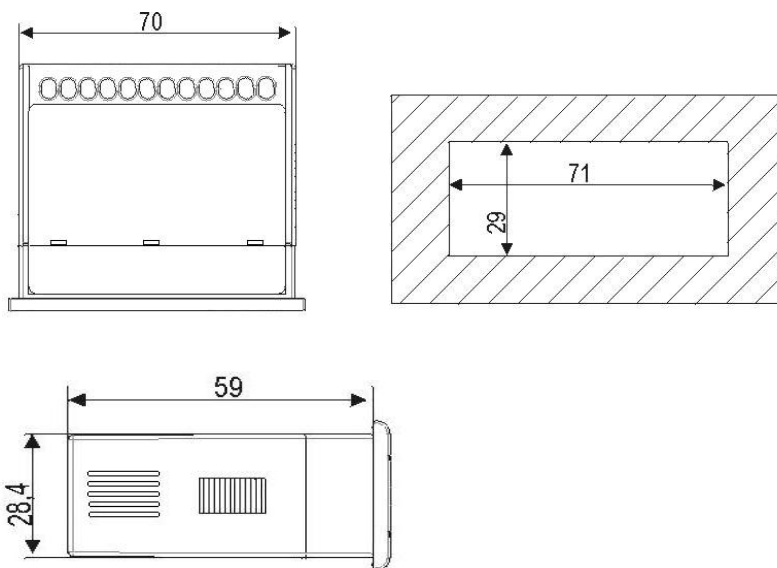

35.2 Remote keyboard

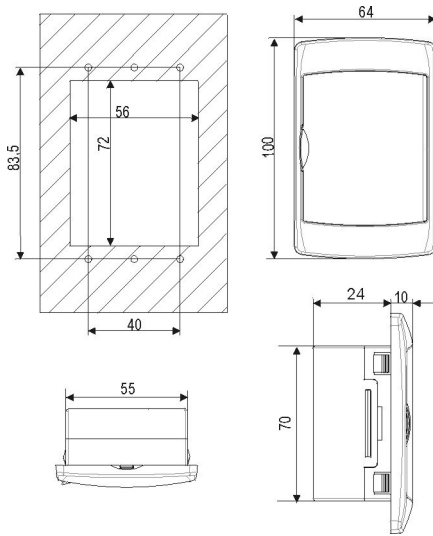

Remote terminal "Vertical" shape

Mounted on a panel with 72x56 mm cut-out, fixed with screw.

To obtain the IP65 protection, even for the panel, use the rubber gasket RGW-V (optional). For wall mounting use the V-KIT plastic adapter as illustrated in figure 2.

Fig. 2

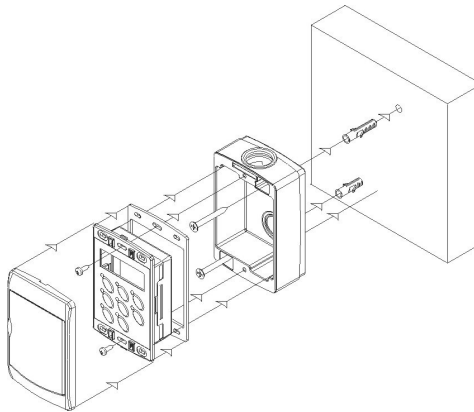

The temperature range allowed for correct operation is $-10\div60^{\circ}\text{C}$. Avoid places subject to strong vibrations, corrosive gases, excessive dirt or humidity. The same recommendations apply to probes. Let air circulate by the cooling holes.

36. ELECTRICAL WIRING

The controller is provided with removable terminal blocks for wires having section not bigger than 1.0 mm²:

14 ways for supply, analogue inputs and digital inputs,

12 ways or 6 ways for relays (depending on model)

Note:

- terminals 17-19 are connected inside the controller (common for the "relay n°1" (terminal 15) and "relay n°2" (terminal 16))
- terminals 21-22 are connected inside the controller (common for the "relay n°3" (terminal 18) and "relay n°4" (terminal 20))

A 5-ways connector is dedicated to the TTL / RS485 interface.

The controller has 4 connectors (depending on model) for remote keyboard, open collector outputs, Pb4 probe, 4..20mA / 0..10Vcc analogue output; the connectors have 2 ways (0.2 mm² wires).

Remote keyboard is provided with 2-ways screw terminal block for wires not bigger than 2.5 mm².

Check power supply data before connection wires.

Keep the probe and the digital input wires separate from the power cable.

Do not exceed the maximum rating current for each relay, check technical data and if the load is bigger, use filtered contactors.

37.3 Model with 5 internal relays and pressure trasducer (Pb3)

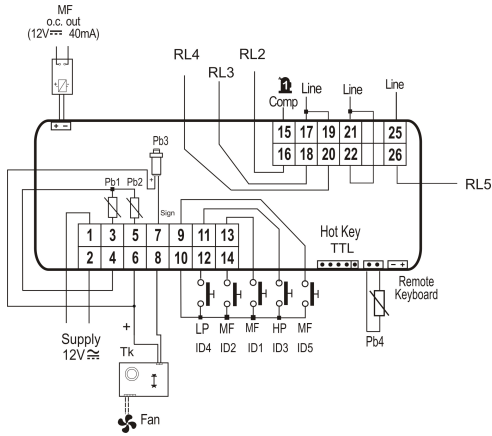

MF ID1, MF ID2, MF ID5 = multifunction digital inputs
ID3 = high pressure digital input
ID4 = low pressure digital input
MF RL2, MF RL3, MF RL4, MF RL5 = multifunction relays
Pb1, Pb2, Pb4 = NTC probe or digital input
Pb3 = pressure trasducer
Tk = output for external fan speed controller
MF o.c. out = multifunction open collector output (for external relay)

37.4 Model with 5 internal relays and ratiometric pressure trasducer (Pb3)

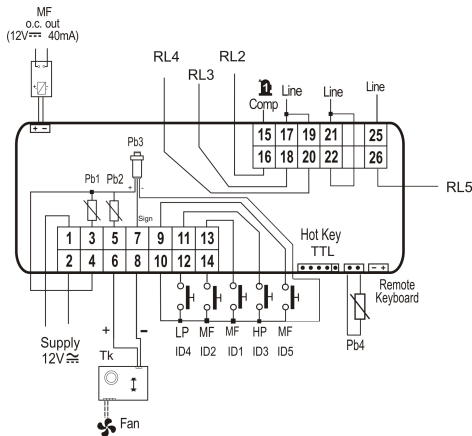

MF ID1, MF ID2, MF ID5 = multifunction digital inputs
ID3 = high pressure digital input
ID4 = low pressure digital input
MF RL2, MF RL3, MF RL4, MF RL5 = multifunction relays
Pb1, Pb2, Pb4 = NTC probe or digital input
Pb3 = ratiometric pressure trasducer
Tk = output for external fan speed controller
MF o.c. out = multifunction open collector output (for external relay)

37.5 Accessories

Serie XV: fan speed controller (0,5KW, 1KW and 2,2KW)

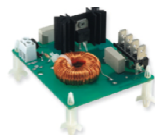

CW15-KIT e CWC15-KIT: Ichill wiring kit for 5 relays model and 4 relays + 1 triac model



XJ485CX: TTL/RS485 serial interface to connect the controller to the supervising system



RT314 Kit: relay module (DIN rail mounting)



Prog TOOL KIT: programming kit to manage parameters map from the Personal Computer



Hot key: parameters copying key



38. TECHNICAL DATA

Housing: Self extinguishing ABS
Case: Front panel 32x74 mm, depth 60mm
Mounting : 29x71 mm panel cut-out
Frontal protection: IP65
Connections: Removable terminal block 12 and 14 ways
Power supply: 12Vac/dc \pm 10%, 24Vac/dc \pm 10%, 50-60Hz
Power absorption: 5VA max
Inputs: 4 NTC probes, or 3 NTC probes and one 4..20mA / 0..10V
Digital inputs: 5 free voltage
Relay outputs: 4 / 5 relays (depending on the model) SPDT 5(3)A, 250Vac
Open collector: 12V, 40mA
Analogue output: 4..20mA / 0..10V
Serial output : TTL standard
Communication protocol: Modbus – RTU
Data storing: on the non-volatile memory (EEPROM)
Kind of action: 1B
Pollution grade: normal
Software class: A
Operating temperature: 0÷60 °C
Storage temperature: -25÷60 °C
Relative humidity: 20÷85% (no condensing)
Measuring range: NTC probe -40÷110°C C (- 40 ÷ 230 °F)
Measuring range: pressure trasducers 0÷ 50 bar
Temperature resolution: 0,1 °C or 1°C
Accuracy (ambient temp. 25°C): \pm 0,5 °C \pm 1 digit

Input/output		Tipo
Probes	Pb1, Pb2 e Pb4	Configurable: NTC, Digital input
	Pb3	Configurable: NTC, 4..20mA, 0..5V
Digital inputs	ID1, ID2 e ID5	Configurable; free voltage
	ID3	High pressure; free voltage
	ID4	Low pressure; free voltage
Relays	RL1	For compressor: relay SPDT 5(3) A 250Vac
	RL2, RL3, RL4 e RL5	Configurable: relè SPDT 5(3) A 250Vac
PWM output / open collector		PWM: modulation of the evaporator fan, open collector: configurable
Open collector output		Configurable; 12 Vcc 40mA max
4..20mA or 0..10V output		Modulation of the evaporator fan or modulation of the evaporator pump
Hot Key / TTL output		Output for Hot Key or Personal computer / supervisor systems
Remote keyboard		Output for remote keyboard

Dixell s.r.l. Z.I. Via dell'Industria, 27
 32010 Pieve d'Alpago (BL) ITALY
 tel. +39 - 0437 - 98 33 - fax +39 - 0437 - 98 93 13
 E-mail: dixell@dixell.com - <http://www.dixell.com>